

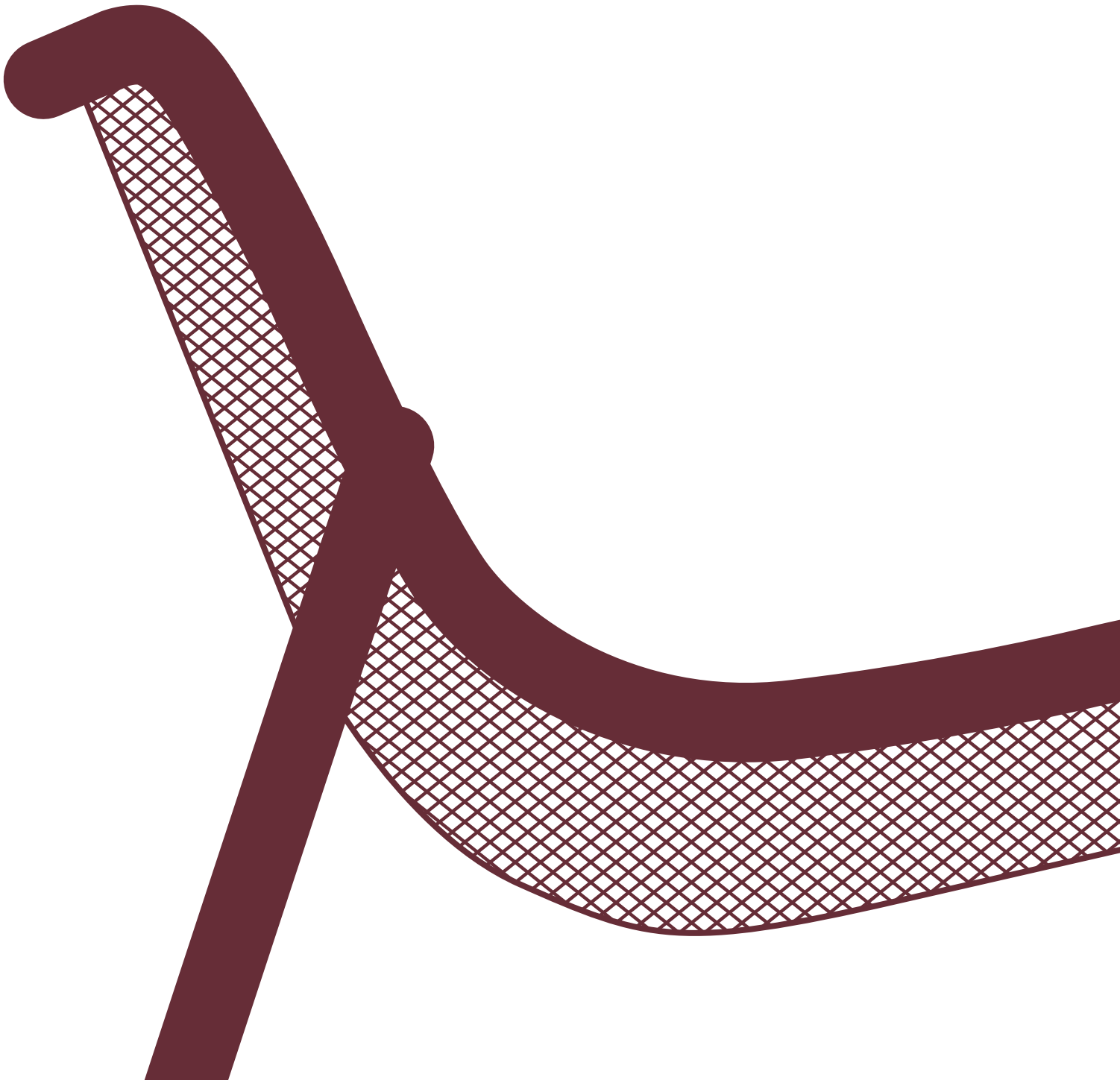

2025
PROFESSIONAL
BOOK





L'AZIENDA OUR COMPANY

Oltre 70 anni di un lungo percorso fatto di innovazione, qualità, sostenibilità e vocazione internazionale. EMU, l'azienda pioniera nel know how tecnico per la lavorazione e la protezione del metallo, produce arredi outdoor sia per la casa che per il contract, adatti a diverse impostazioni stilistiche, creando ambienti autentici e ideali per vivere gli spazi all'aperto tra comfort, convivialità e relax. Con una spinta e un'intuizione rivoluzionaria, EMU è tra le prime aziende a instaurare una serie di collaborazioni con i più noti creativi e architetti italiani e internazionali, introducendo così il design nel settore outdoor. Profondamente legata alla filosofia produttiva 100% Made in Italy e sempre coerente con la cultura del proprio territorio, l'azienda è presente oggi nel mercato internazionale con una rete distributiva che copre oltre 85 Paesi. Il costante investimento in alta tecnologia, ricerca e automazione, il saper fare italiano e l'internazionalizzazione, oggi si traducono in: 140.000 mq di stabilimento, 3.800 tonnellate di materie prime trasformate annualmente, 450.000 pezzi prodotti ogni anno, 140.000 mq di stabilimento, 3.800 tonnellate di materie prime trasformate.

A long journey lasting over 70 years, through innovation, quality, sustainability and international orientation. EMU, a company at the forefront of technical know-how in the processing and protection of metal, produces both domestic and contract outdoor furniture suitable for different styles, to create authentic and ideal environments to enjoy the outdoors with comfort, conviviality, and relaxation. With its revolutionary drive and intuition, EMU was among the first companies to establish a series of collaborations with the most famous Italian and international creators and architects, thus introducing design to the outdoor sector. With its deep commitment to the 100% Made in Italy production philosophy and unwavering faithfulness to the culture of its homeland, the company is currently present on the international market with a distribution network that covers over 85 countries. Constant investments in high technology, research and automation, Italian know-how and international approach translate today into 140,000 square meters of plant, 3,800 tons of raw materials annually processed, 450,000 pieces produced every year.



EMU NEL CONTRACT EMU IN THE CONTRACT SECTOR

Le caratteristiche degli arredi rendono EMU il partner ideale per tutti gli utilizzi contract. Durevolezza ed affidabilità sono il valore aggiunto di EMU, brand riconosciuto in tutto il mondo come sinonimo di garanzia. Ogni arredo è progettato per resistere alla particolare usura e alle più avverse condizioni atmosferiche. Tutti i prodotti sono sottoposti ad un rigoroso processo di cataforesi per la protezione e finitura dei metalli, che garantisce la longevità all'esterno. La praticità, l'impilabilità, l'utilizzo di un'ampia gamma di tessuti nonché l'estrema funzionalità, confermano l'impiego dei prodotti EMU, rispondendo perfettamente alle esigenze del settore Contract e Hospitality, nelle differenti tipologie di destinazione d'uso.

EMU furnishings' features make the company the ideal partner for all contract uses. A combination of durability and reliability is the added value of EMU and makes the brand recognized as affordable all over the world. Each piece of furniture is designed to withstand to high usage and extreme weather conditions. All our products are subjected to a rigorous cathaphoresis process of protection and finishing of metals to ensure long lasting outdoor products. Practicality and stackability wide range of fabrics, even the high functionality performance contribute to making EMU products user-friendly and meets the needs of Contract and Hospitality segments, for the all contexts of use.



EMU E L'AMBIENTE EMU AND THE ENVIRONMENT

L'impegno che EMU pone verso l'ambiente copre l'intero ciclo di vita del prodotto, dall'impiego di materiali riciclabili al 100% e incombustibili, come l'acciaio e l'alluminio, al riciclo e alla minimizzazione degli scarti. Le collezioni contenenti legno sono realizzate in teak FSC® 100%, ovvero proveniente da foreste gestite in maniera responsabile secondo rigorosi standard ambientali, sociali ed economici; in bambù materiale di origine naturale raccolto senza causare deforestazione. Vernici spray VOC free (Volatile Organic Compound) permettono una diffusione più uniforme e di conseguenza uno spreco minore di prodotto. EMU-Tex, tessuto tecnico per esterni utilizzato per sdraio e lettini, privo di ftalati. HPL, utilizzato per alcuni top, completamente atossico e costituito per il 70% da fonti rinnovabili, con certificazioni FSC e PEFC e di ISO 9001 e ISO 14001. La compatibilità ambientale di tutta la gamma EMU è garantita anche dall'impegno nel ridurre costantemente la plastica negli imballi, usando cartone riciclabile dalle dimensioni sempre più contenute. EMU pone particolare attenzione a ridurre il ricorso a energia derivata da fonti fossili, per questo alimenta parte del suo fabbisogno energetico attraverso l'utilizzo di un proprio impianto fotovoltaico da 1 megawatt, con l'intenzione di avviare un progetto per aumentare la copertura. L'azienda ha sempre avuto cura del suo territorio: l'Umbria, Cuore Verde d'Italia.

EMU's dedication to the environment involves the entire life cycle of the product, from the use of 100% recyclable and incombustible materials like steel and aluminium, to waste minimisation and recycling. The collections containing wood are made from 100% FSC® teak, which means it comes from responsibly managed forests according to rigorous environmental, social, and economic standards; and from bamboo, a material of natural origin harvested without causing deforestation. Spray paints free from VOC (Volatile Organic Compounds) give a more even coating, resulting in less product waste. EMU-Tex, a phthalate-free technical fabric for outdoors, used for deckchairs and sunbeds. HPL, used for some tabletops, completely non-toxic and made from 70% renewable sources, with FSC, PEFC, ISO 9001 and ISO 14001 certifications. The environmental compatibility of the entire EMU range is also guaranteed by its commitment to constantly reducing the use of plastic in packaging, which is increasingly small and made up of recyclable cardboard. EMU pays particular attention to reducing its reliance on fossil fuel energy. For this reason, it supplies part of its energy needs through the use of its own 1-megawatt photovoltaic system, with the intention of launching a project to increase its energy requirement coverage. The company has always taken care of its home: Umbria, the Green Heart of Italy.

ITALIAN KNOW HOW: UNA GARANZIA DI QUALITÀ ITALIAN KNOW-HOW: GUARANTEED QUALITY

Profondamente legata alla filosofia produttiva Made in Italy e coerente con la cultura del proprio territorio, l'azienda realizza e controlla tutte le fasi della fabbricazione nel suo stabilimento di Marsciano, nel cuore dell'Umbria, e coordina nelle altre sedi tutte le fasi produttive in un network integrato secondo i più moderni modelli di organizzazione. Un rigoroso monitoraggio che parte dai test durante la progettazione e lavorazione, passa attraverso i processi di cataforesi e verniciatura e arriva alla validazione del prodotto finito, assicurando arredi con un lungo ciclo di vita ed una massima resistenza all'utilizzo e agli agenti atmosferici. Infine, tecnici e designer possono trovare, all'interno del Design & Simulation Centre, il luogo ideale per dare impulso alle attività di ricerca e sviluppo. Una cultura che EMU promuove aderendo a progetti universitari ed ospitando frequentemente studenti nel suo reparto di Ricerca & Sviluppo.

EMU is deeply committed to the Made in Italy production philosophy and it is consistent with the culture of its territory. The company carries out and monitors all stages of manufacture at its factory in Marsciano in the heart of Umbria, and coordinates all production stages at its other sites, in an integrated network that follows the most modern organisation models. Strict monitoring is conducted, starting with tests during design and manufacturing, continuing through the processes of cathaphoresis and painting, all the way up to the validation of the finished product. These steps make furnishing solutions that ensure the products' long life cycle and excellent resistance against weather conditions. Finally, the Design & Simulation Centre is the ideal place for engineers and designers to boost research and development. This is a culture that EMU promotes by joining university projects and by hosting students, offering them a professional experience in its Research & Development department.



INDICE COLLEZIONI COLLECTIONS INDEX

SEDUTE SEATINGS

18	ALA	80	MOM
20	ANGEL	82	NEF
24	APERO	84	PIGALLE
26	ARC EN CIEL	86	RE-TROUVÉ
28	ATHENA	88	RIO R50
32	CAFÉ	92	RIVIERA
34	CAPRERA	96	RONDA
36	CAROUSEL	98	RONDA X
44	CIAK	100	ROUND
46	CODE	104	SEGNO
48	COLLIER	108	SHINE
54	COMO	116	SNOOZE
60	COUPOLE	118	SOLE
62	DARWIN	120	STAR
66	GRACE	128	TERRAMARE
68	HEAVEN	130	THOR
72	HOLLY	132	TWINS
74	LYZE	138	URBAN
78	MIA	140	YARD

TAVOLI A 4 GAMBE 4-LEGGED TABLES

148	ANGEL	172	ROUND 
150	ARC EN CIEL	174	SHINE 
152	ATHENA 	176	STAR
154	CAMBI	178	TERRAMARE 
160	NOVA	182	TWINS
164	PIGALLE	184	URBAN
166	PLUS4 	186	YARD 
170	QUADRO		

 Tavoli allungabili—Extensible tables

TAVOLI A PALO CENTRALE CENTRAL POLE TABLES

192	COLLIER	208	RE-TROUVÉ
194	COMO	210	ROUND
196	DARWIN	214	SHINE
202	GRACE	216	TABLE SYSTEM
204	HEAVEN	218	TERRAMARE
206	HPL TOPS	220	THOR

POLTRONE E DIVANI ARMCHAIRS AND SOFAS

226	ANGEL
230	CABLA
236	CANNOLÈ
242	IVY
244	REEL
248	TAMI
256	TERRA
260	TERRAMARE
264	TWINS

TAVOLI BASSI COFFEE TABLES

276	ANGEL	294	HOLLY
278	ATHENA	294	IVY
280	CABLA	296	RIO R50
282	CANNOLÈ	298	ROUND
284	CAROUSEL	300	SHINE
286	COLLIER	300	TAMI
288	COMO	302	TERRAMARE
290	DARWIN	304	TWINS
292	HEAVEN	306	YARD

LETTINI E SDRAIO SUNBEDS AND DECK CHAIRS

312	BAHAMA	326	TERRAMARE
314	HOLLY	328	TIKI
316	ROUND	330	YARD
318	SHINE		
322	SNOOZE		

COMPLEMENTI COMPLEMENTS

334	CAMALEON	352	LUCIOLE
338	CONE	354	OTTOMAN
342	EMILY	356	PATCHWALL
346	FICUS	358	RE-TROUVÉ
350	HEAVEN	360	RED CARPET

CUSCINI CUSHIONS

368	DECORATIVE CUSHIONS
370	EMU CUSHIONS
371	MAGNETIC CUSHIONS
372	UNIVERSAL CUSHIONS



TIPOLOGIE E MATERIALI

CATEGORIES AND MATERIALS

	Sedia—Chair	Poltroncina—Armchair	Sgabello—Barstool	Tavolo alto—Counter table	Tavolo—Table	Tavolo basso—Coffee table	Panchina—Bench	Poltrona—Lounge chair	Poltrona dondolo—Rocking lounge chair	Pouf / Poggiapedi—Pouf / Footrest	Divano—Sofa	Divano modulare—Modular sofa	Letino—Sunbed	Sdraio—Deck chair	Lampada—Lamp	Complementi—Complements	Cucina—Kitchen	Acciaio—Steel	Alluminio—Aluminium	Legno—Wood
ANGEL		●		●	●		●			●								●	●	
ALA	●	●																●		
APER0	●	●	●															●		
ARCE NCIEL	●				●													●		
ATHENA		●			●	●		●		●								●		
BAHAMA													●					●		
CABLA						●		●			●							●		
CAFÉ	●	●	●															●		
CAMALEON															●				●	
CAMBI					●													●		
CANNOLÉ					●		●		●		●							●		
CAPRERA	●	●																●		
CAROUSEL		●			●		●		●	●									●	
CIAK		●							●										●	
CODE	●																	●		
COLLIER	●	●			●	●		●										●		
COMO	●	●			●	●		●		●								●		
CONE														●				●		
COUPOLE	●		●															●		
DARWIN	●	●	●	●	●	●		●		●								●		
EMILY																●			●	
FICUS																●				
GRACE	●	●	●		●														●	
HEAVEN	●	●			●	●		●		●								●		
HOLLY		●			●		●		●			●							●	
HPL TOPS					●															
IVY					●		●			●								●		
LUCIOLE															●	●				
LYZE	●	●					●												●	●
MIA	●	●	●															●		
MOM	●	●																●		

	Sedia—Chair	Poltroncina—Armchair	Sgabello—Barstool	Tavolo alto—Counter table	Tavolo—Table	Tavolo basso—Coffee table	Panchina—Bench	Poltrona—Lounge chair	Poltrona dondolo—Rocking lounge chair	Pouf / Poggiapedi—Pouf / Footrest	Divano—Sofa	Divano modulare—Modular sofa	Letino—Sunbed	Sdraio—Deck chair	Lampada—Lamp	Complementi—Complements	Cucina—Kitchen	Acciaio—Steel	Alluminio—Aluminium	Legno—Wood	
NEF		●						●											●		
NOVA				●	●														●		
OTTOMAN																●					
PATCHWALL																●		●			
PIGALLE	●	●			●													●			
PLUS4					●													●			
QUADRO					●													●			
RE-TROUVÉ	●	●			●				●							●		●			
RED CARPET																●					
REEL								●										●			
RIOR50	●	●	●			●		●										●			
RIVIERA	●	●	●					●										●			
RONDA	●	●	●															●			
RONDAX	●	●	●															●			
ROUND	●	●	●	●	●	●		●				●						●			
SEGNO	●	●	●				●											●		●	
SHINE	●	●	●	●	●	●		●		●		●							●	●	
SNOOZE		●							●			●	●					●			
SOLE	●	●																●			
STAR	●	●	●		●		●		●									●			
STAR	●	●					●												●		
TABLESYSTEM					●													●			
TAMI					●		●			●									●	●	
TERRA							●		●										●		
TERRAMARE		●			●	●		●		●		●							●		
THOR	●		●		●													●		●	
TIKI												●							●		
TWINS	●	●					●		●										●	●	
TWINS	●	●			●	●		●		●									●	●	
URBAN	●	●			●														●		
YARD	●	●	●	●	●	●		●		●		●							●		

INDICE COLORI PER COLLEZIONE

COLORS COLLECTIONS INDEX



ANGEL	●	●	●	●	●	●	●	●	●	●	●	●	●	●	●	●
ALA	●	●	●	●	●	●	●	●	●	●	●	●	●	●	●	●
APERERO	●	●	●	●	●	●	●	●	●	●	●	●	●	●	●	●
ARCENCIEL	●	●	●	●	●	●	●	●	●	●	●	●	●	●	●	●
ATHENA	●	●	●	●	●	●	●	●	●	●	●	●	●	●	●	●
BAHAMA	●	●	●	●	●	●	●	●	●	●	●	●	●	●	●	●
CABLA	●	●	●	●	●	●	●	●	●	●	●	●	●	●	●	●
CAFÉ	●	●	●	●	●	●	●	●	●	●	●	●	●	●	●	●
CAMALEON	●	●	●	●	●	●	●	●	●	●	●	●	●	●	●	●
CAMBI	●	●	●	●	●	●	●	●	●	●	●	●	●	●	●	●
CANNOLÉ	●	●	●	●	●	●	●	●	●	●	●	●	●	●	●	●
CAPRERA	●	●	●	●	●	●	●	●	●	●	●	●	●	●	●	●
CAROUSEL	●	●	●	●	●	●	●	●	●	●	●	●	●	●	●	●
CIAK	●	●	●	●	●	●	●	●	●	●	●	●	●	●	●	●
CODE	●	●	●	●	●	●	●	●	●	●	●	●	●	●	●	●
COLLIER	●	●	●	●	●	●	●	●	●	●	●	●	●	●	●	●
COMO	●	●	●	●	●	●	●	●	●	●	●	●	●	●	●	●
CONE	●	●	●	●	●	●	●	●	●	●	●	●	●	●	●	●
COUPOLE	●	●	●	●	●	●	●	●	●	●	●	●	●	●	●	●
DARWIN	●	●	●	●	●	●	●	●	●	●	●	●	●	●	●	●
EMILY	●	●	●	●	●	●	●	●	●	●	●	●	●	●	●	●
FICUS	●	●	●	●	●	●	●	●	●	●	●	●	●	●	●	●
GRACE	●	●	●	●	●	●	●	●	●	●	●	●	●	●	●	●
HEAVEN	●	●	●	●	●	●	●	●	●	●	●	●	●	●	●	●
HOLLY	●	●	●	●	●	●	●	●	●	●	●	●	●	●	●	●
HPL TOPS	●	●	●	●	●	●	●	●	●	●	●	●	●	●	●	●
IVY	●	●	●	●	●	●	●	●	●	●	●	●	●	●	●	●
LUCIOLE	●	●	●	●	●	●	●	●	●	●	●	●	●	●	●	●
LYZE	●	●	●	●	●	●	●	●	●	●	●	●	●	●	●	●



MIA	●	●	●	●	●	●	●	●	●	●	●	●	●	●	●	●
MOM	●	●	●	●	●	●	●	●	●	●	●	●	●	●	●	●
NEF	●	●	●	●	●	●	●	●	●	●	●	●	●	●	●	●
NOVA	●	●	●	●	●	●	●	●	●	●	●	●	●	●	●	●
PATCHWALL	●	●	●	●	●	●	●	●	●	●	●	●	●	●	●	●
PIGALLE	●	●	●	●	●	●	●	●	●	●	●	●	●	●	●	●
PLUS4	●	●	●	●	●	●	●	●	●	●	●	●	●	●	●	●
QUADRO	●	●	●	●	●	●	●	●	●	●	●	●	●	●	●	●
RE-TROUVÉ	●	●	●	●	●	●	●	●	●	●	●	●	●	●	●	●
REEL	●	●	●	●	●	●	●	●	●	●	●	●	●	●	●	●
RIO R50	●	●	●	●	●	●	●	●	●	●	●	●	●	●	●	●
RIVIERA	●	●	●	●	●	●	●	●	●	●	●	●	●	●	●	●
RONDA	●	●	●	●	●	●	●	●	●	●	●	●	●	●	●	●
RONDAX	●	●	●	●	●	●	●	●	●	●	●	●	●	●	●	●
ROUND	●	●	●	●	●	●	●	●	●	●	●	●	●	●	●	●
SEGNO	●	●	●	●	●	●	●	●	●	●	●	●	●	●	●	●
SHINE	●	●	●	●	●	●	●	●	●	●	●	●	●	●	●	●
SNOOZE	●	●	●	●	●	●	●	●	●	●	●	●	●	●	●	●
SOLE	●	●	●	●	●	●	●	●	●	●	●	●	●	●	●	●
STAR	●	●	●	●	●	●	●	●	●	●	●	●	●	●	●	●
TABLESYSTEM	●	●	●	●	●	●	●	●	●	●	●	●	●	●	●	●
TAMI	●	●	●	●	●	●	●	●	●	●	●	●	●	●	●	●
TERRA	●	●	●	●	●	●	●	●	●	●	●	●	●	●	●	●
TERRAMARE	●	●	●	●	●	●	●	●	●	●	●	●	●	●	●	●
THOR	●	●	●	●	●	●	●	●	●	●	●	●	●	●	●	●
TIKI	●	●	●	●	●	●	●	●	●	●	●	●	●	●	●	●
TWINS	●	●	●	●	●	●	●	●	●	●	●	●	●	●	●	●
URBAN	●	●	●	●	●	●	●	●	●	●	●	●	●	●	●	●
YARD	●	●	●	●	●	●	●	●	●	●	●	●	●	●	●	●

INDICE DIMENSIONI TAVOLI SIZES TABLES INDEX

	50CM	60CM			70CM			80CM					
	X70	X60	Ø60	X70	Ø71	X70	X110	X80	Ø80	X120	X140	X160	X180
ANGEL	●	●	●	●	●	●	●	●	●	●	●	●	●
ARCENCIEL	●	●	●	●	●	●	●	●	●	●	●	●	●
CAMBI	●	●	●	●	●	●	●	●	●	●	●	●	●
COLLIER	●	●	●	●	●	●	●	●	●	●	●	●	●
COMO	●	●	●	●	●	●	●	●	●	●	●	●	●
DARWIN	●	●	●	●	●	●	●	●	●	●	●	●	●
GRACE	●	●	●	●	●	●	●	●	●	●	●	●	●
HEAVEN	●	●	●	●	●	●	●	●	●	●	●	●	●
NOVA	●	●	●	●	●	●	●	●	●	●	●	●	●
PIGALLE	●	●	●	●	●	●	●	●	●	●	●	●	●
RE-TROUVÉ	●	●	●	●	●	●	●	●	●	●	●	●	●
ROUND	●	●	●	●	●	●	●	●	●	●	●	●	●
SHINE	●	●	●	●	●	●	●	●	●	●	●	●	●
STAR	●	●	●	●	●	●	●	●	●	●	●	●	●
TABLESYSTEM	●	●	●	●	●	●	●	●	●	●	●	●	●
TERRAMARE	●	●	●	●	●	●	●	●	●	●	●	●	●
THOR	●	●	●	●	●	●	●	●	●	●	●	●	●
TWINS	●	●	●	●	●	●	●	●	●	●	●	●	●
QUADRO	●	●	●	●	●	●	●	●	●	●	●	●	●
URBAN	●	●	●	●	●	●	●	●	●	●	●	●	●

	90CM			103CM	105CM		106CM	141CM	150CM	Ø				
	Ø90	X90	X160	X103	X105	Ø105	Ø106	X141	X150	Ø117	Ø120	Ø130	Ø144	Ø149
ANGEL	●	●	●	●	●	●	●	●	●	●	●	●	●	●
ARCENCIEL	●	●	●	●	●	●	●	●	●	●	●	●	●	●
CAMBI	●	●	●	●	●	●	●	●	●	●	●	●	●	●
COLLIER	●	●	●	●	●	●	●	●	●	●	●	●	●	●
COMO	●	●	●	●	●	●	●	●	●	●	●	●	●	●
DARWIN	●	●	●	●	●	●	●	●	●	●	●	●	●	●
GRACE	●	●	●	●	●	●	●	●	●	●	●	●	●	●
HEAVEN	●	●	●	●	●	●	●	●	●	●	●	●	●	●
NOVA	●	●	●	●	●	●	●	●	●	●	●	●	●	●
PIGALLE	●	●	●	●	●	●	●	●	●	●	●	●	●	●
RE-TROUVÉ	●	●	●	●	●	●	●	●	●	●	●	●	●	●
ROUND	●	●	●	●	●	●	●	●	●	●	●	●	●	●
SHINE	●	●	●	●	●	●	●	●	●	●	●	●	●	●
STAR	●	●	●	●	●	●	●	●	●	●	●	●	●	●
TABLESYSTEM	●	●	●	●	●	●	●	●	●	●	●	●	●	●
TERRAMARE	●	●	●	●	●	●	●	●	●	●	●	●	●	●
THOR	●	●	●	●	●	●	●	●	●	●	●	●	●	●
TWINS	●	●	●	●	●	●	●	●	●	●	●	●	●	●
QUADRO	●	●	●	●	●	●	●	●	●	●	●	●	●	●
URBAN	●	●	●	●	●	●	●	●	●	●	●	●	●	●

LEGENDA DEI SIMBOLI SYMBOLS LEGEND



CATEGORIE—CATEGORIES

Icona	Descrizione
	Sedute—Seatings
	Tavoli a 4 gambe 4-legged tables
	Tavoli a palo centrale Central pole tables

Icona	Descrizione
	Poltrone e Divani Armchairs and Sofas
	Tavoli bassi Coffee Tables
	Lettoni e Sdraio Sunbeds and Deck Chairs

Icona	Descrizione
	Complementi Complements

MATERIALI—MATERIALS

Icona	Descrizione	Note
	Acciaio—Steel	● Lega di ferro e carbonio con percentuale di carbonio inferiore al 2% trattata per resistere agli agenti atmosferici con l'esclusivo processo anticorrosione EMU-Coat. Iron and carbon alloy, with carbon content below 2%, treated to withstand the weather conditions with the unique EMU-coating treatment.
	Alluminio—Aluminium	● Leghe di alluminio, particolarmente idonee per la lavorazione a freddo e per la pressofusione, trattate opportunamente per resistere agli agenti atmosferici e verniciate a polvere. Powder coated aluminium alloys, particularly suitable for cold-working and for die-casting, appropriately treated to withstand the weather conditions.
	Legno—Wood	● Materiale naturale derivato da specie vegetali. Il bambù è un materiale derivato dalla pianta di bambù. Il teak è un legno duro ad alto contenuto di olio adatto all'uso esterno senza necessità di trattamento di verniciatura. Il teak utilizzato per i prodotti EMU è certificato FSC®. Natural material obtained from plant species. Bamboo is a material obtained from the bamboo plant. Teak is a hard wood with a high oil content suitable for outdoor use, without the need for painting. The teak used for EMU products is FSC® certified.

INFORMAZIONI—INFORMATION

Icona	Descrizione	Note
	Riciclabilità—Recyclability	Indica che il materiale è recuperabile e riutilizzabile per la produzione di un nuovo prodotto. Schede riciclabilità disponibili all'interno della sezione "Prodotti" del sito www.emu.it . Indicates that the material is recyclable and reusable for the production of a new product. Recycling data sheets available on "Products" area of www.emu.it .
	Configurabile sul sito Configurable on website	Indica che il prodotto può essere personalizzato e visualizzato sul sito con le diverse combinazioni di colori e tessuti. Indicates that the product can be customized and seen on the website with the different combinations of colors and fabrics.

INFORMAZIONI TECNICHE—TECHNICAL INFORMATION

Icona	Descrizione	Note
	Trattamento Treatment	La lettera C accanto all'icona indica che l'acciaio ha ricevuto un trattamento superficiale protettivo di cataforesi. La lettera Z accanto all'icona indica che l'acciaio ha ricevuto un trattamento superficiale protettivo di zincatura. The letter C next to the icon indicates that the steel surface has received a protective cathodesis treatment. The letter Z next to the icon indicates that the steel surface has received a protective galvanizing treatment.
	Carico statico (in Kg) Static load (in Kg)	Per le sedute si riferisce al carico statico esercitato sulla singola seduta, per i tavoli alla forza esercitata in punti prestabiliti del piano. È previsto dai test comunitari inerenti ai requisiti meccanici dei prodotti. For the seating this refers to the static load applied to the single seat, and for the table to the force applied to pre-established points of the table-top. It is required to be compliant to the international standards in terms of mechanical performances.
	Resistente all'esterno Resistant to outdoor exposure	
	Cuscino seduta+schienale Seat+back cushion	Indica che al prodotto può essere abbinato il cuscino seduta + schienale. Indicates that a seat-back cushion can be combined with the product.
	Cuscino seduta Seat cushion	Indica che al prodotto può essere abbinato il cuscino seduta. Indicates that a seat cushion can be combined with the product.
	Cuscino schienale Back cushion	Indica che al prodotto può essere abbinato il cuscino schienale. Indicates that a back cushion can be combined with the product.
	Piano in cristallo Glass top	Indica che al prodotto può essere abbinato il piano in cristallo. Indicates that a glass top can be combined with the product.
	Impilabile Stackable	Il numero accanto all'icona indica il numero massimo di sedie impilabili. The number at the top gives the maximum number of products that can be stacked.
	Pieghevole—Foldable	
	Reclinabile—Reclining	
	Allungabile—Extensible	
	Abbattibile—Collapsible	
	Cover	Indica che al prodotto può essere abbinato il telo di protezione. Indicates that a matching protective cover can be combined with the product.
	Codice IP—IP code	Il codice IP (International Protection) indica il grado di protezione degli involucri dei dispositivi elettrici ed elettronici contro la penetrazione di agenti esterni di natura solida o liquida. The International Protection code (IP) indicates the degree of protection of electrical and electronic device, casings against the penetration of solid or liquid external agents.
	Protezione raggi UV UV ray protection	Il numero accanto all'icona indica il valore di protezione del prodotto ai raggi ultravioletti secondo la classificazione UPF. The number on the right indicates the UV rays protection of the product in the UPF range.
	FSC®	Indica prodotti contenenti materiali certificati FSC®, ovvero provenienti da foreste gestite in maniera responsabile secondo rigorosi standard ambientali, sociali ed economici. Indicates products containing FSC® certified materials which come from responsibly managed forests, following rigorous environmental, social and economic standards.



RE-TROUVÉ—NOVOTEL HEATHROW AIRPORT—UK



COLLIER—VILLA MONTY BANKS—ITALY

EMU NEL MONDO EMU IN THE WORLD



ROUND—KOMBUIS RESTAURANT—SOUTH AFRICA



SEDUTE SEATINGS

Le sedute EMU sono concepite per una straordinaria esperienza e fruizione, reinterprestando con carattere gli spazi sia esterni che interni. La loro trasversalità per design, materiale e funzionalità, permette di scegliere tra molteplici soluzioni: sedute impilabili e pieghevoli, con o senza braccioli, con cuscini dedicati e diverse finiture. Le sedie EMU, certificate da enti riconosciuti a livello internazionale, sono una sintesi perfetta tra tecnologia, estetica e comfort, una garanzia di eccezionale prestazione, anche nell'utilizzo prolungato e in condizioni atmosferiche estreme.

EMU seatings are designed to enhance the user experience and reimagine indoor and outdoor spaces with style. The large appeal of the design, materials and functions allows to choose among several solutions: stackable or foldable seatings with or without armrests, with specific cushions and various finishes. EMU chairs are certified by internationally recognized authorities and provide the perfect combination of technology, aesthetics and comfort to ensure performance over many years in extreme weather conditions.

INDEX

18	ALA	●	80	MOM	●
20	ANGEL	●	82	NEF	●
24	APERÒ	●	84	PIGALLE	●
26	ARC EN CIEL	●	86	RE-TROUVÉ	●
28	ATHENA	●	88	RIO R50	●
32	CAFÉ	●	92	RIVIERA	●
34	CAPRERA	●	96	RONDA	●
36	CAROUSEL	●	98	RONDA X	●
44	CIAK	●	100	ROUND	●
46	CODE	●	104	SEGNO	●●
48	COLLIER	●	108	SHINE	●●
54	COMO	●	116	SNOOZE	●
60	COUPOLE	●	118	SOLE	●
62	DARWIN	●	120	STAR	●●
66	GRACE	●	128	TERRAMARE	●
68	HEAVEN	●	130	THOR	●●
72	HOLLY	●	132	TWINS	●●
74	LYZE	●●	138	URBAN	●
78	MIA	●	140	YARD	●

LEGENDA—LEGEND
 ● Acciaio—Steel
 ● Alluminio—Aluminium
 ● Legno—Wood



Scansiona e scopri i progetti.
Scan and discover the projects.

150
Sedia
Chair



Lamiere zincate a caldo forata effetto finto intreccio.
Hot-dip zincated metal sheet with simulated woven wire mesh.

151
Poltroncina
Armchair



Fissaggio cuscino con laccetti.
Cushion fastening with laces.

PRODOTTI—PRODUCTS

Codice/Code Tipologia/Typology	Disegno/Drawing	Info	TEST
-----------------------------------	-----------------	------	------

150 Sedia Chair W57 - D58 - H86 Kg 5,3			EN581-1/ EN581-2
--	--	--	------------------

151 Poltroncina Armchair W58 - D58 - H86 Kg 6,0			EN581-1/ EN581-2
---	--	--	------------------

COLORI STRUTTURA—FRAME COLORS

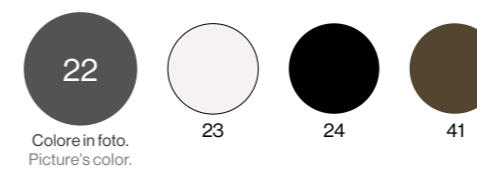

CUSCINI—CUSHIONS

Codice/Code Tipologia/Typology	Colori tessuto Fabric colors	Categoria tessuto Fabric category
C/152 Cuscino seduta acrilico Acrylic seat cushion x cod. 150, 151 W40/44 - D36 - H2 Kg 0,17		Tessuti Basic Basic Fabrics
C/714 Cuscino magnetico poliestere quadrato Polyester square magnetic cushion x cod. 150, 151 W39- D37 - H1,5 Kg 0,23		Tessuti Cuscini Contract Contract Cushions Fabrics

* Cuscino visibile in foto—Cushion in the picture

COMBINAZIONI CONSIGLIATE—SUGGESTED MATCHINGS



CAMBI
Cod. 804
Tavolo tondo 5 posti
5 seats round table
PAG. 156



CAMBI
Cod. 808
Tavolo rettangolare 6 posti
6 seats rectangular table
PAG. 156



ATHENA
Cod. 3425P+3429B
Tavolo allungabile
8+2/4 posti
8+2/4 seats
extensible table
PAG. 152

PLUS

- Tubo acciaio cataforizzato e verniciato.—Cataphorised and painted steel pipe.
- Saldatura a proiezione della rete alla struttura in tubolare per un migliore effetto estetico.
Spot welded mesh to the tubular frame which gives a more refined aesthetic effect.
- Cuscino magnetico C/714 in abbinamento.—C/714 matching magnetic cushion.

ANGEL

Design by Angeletti—Ruzza



Scansiona e scopri i progetti.
Scan and discover the projects.

9042
Poltroncina
Armchair



Struttura dall'estetica caratterizzante grazie al design del profilo di alluminio esclusivo EMU.
Characterizing aesthetics frame thanks to the design of the exclusive EMU aluminum profile.



C/9042 cuscino seduta è fissato alla seduta anteriormente tramite pratico sistema.
C/9042 seat cushion is fixed to the seat using special details.

PRODOTTI—PRODUCTS

Codice/Code Tipologia/Typology	Disegno/Drawing	Info
-----------------------------------	-----------------	------

9042
Poltroncina
Armchair
W58 - D57,5 - H78
Kg 5,4

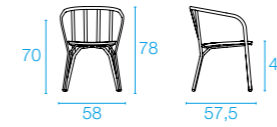

COLORI STRUTTURA—FRAME COLORS

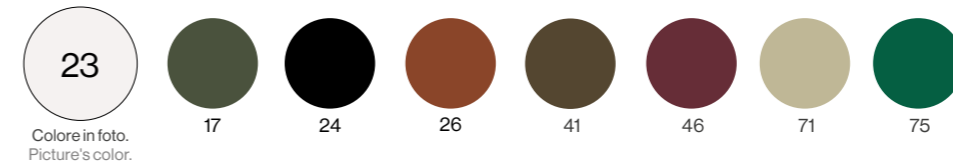

CUSCINI—CUSHIONS

Codice/Code Tipologia/Typology	Colori tessuto Fabric colors	Categoria tessuto Fabric category
C/9042 Cuscino seduta Seat cushion x cod. 9042 W45 - D45 - H3 Kg 0,4		Tessuti Basic (Vedi riepilogo pg. 22) Tessuti Standard (Vedi riepilogo pg. 22)* Tessuti Exclusive (Vedi riepilogo pg. 22) Basic Fabrics (Look at pg. 22) Standard Fabrics (Look at pg. 22)* Exclusive Fabrics (Look at pg. 22)
FC/1210 Cover x cod. 9042		

* Cuscino visibile in foto 900/18 Madreperla—Cushion in the picture 900/18 Nacre

ALTRI PRODOTTI IN COLLEZIONE—OTHER COLLECTION'S PRODUCTS

20



ANGEL
Cod. 9051
Tavolo tondo 6 posti
6 seats round table
PAG. 148



ANGEL
Cod. 9053
Tavolo rettangolare 8 posti
8 seats rectangular table
PAG. 148



ANGEL
Cod. 9045+C/9045+C/9044
Poltrona
Lounge chair
PAG. 226

PLUS

• Ispirazione neoclassica che qualifica la collezione per differenti destinazioni d'uso di tipologia contract, sia dining che lounge.

Neoclassical inspiration that qualifies the collection for different contract uses, whether dining or lounge.

21



TESSUTI CUSCINI—CUSHION FABRICS C/9042

Composizione/Categoria tessuti Composition/Fabrics category	Colori Colors
TESSUTI BASIC—BASIC FABRICS	
Acrilico—Acrylic	700/4
	700/10
	700/13
	700/32
700/34	
TESSUTI STANDARD—STANDARD FABRICS	
88% Acrilico, 12% Poliestere—88% Acrylic, 12% Polyester	900/02
	900/05
	900/07
	900/08
900/09	
Acrilico—Acrylic	900/18
	900/71
	900/75
	900/77
TESSUTI EXCLUSIVE—EXCLUSIVE FABRICS	
CAT. E Visitare il nostro sito web www.emu.it —Visit our website www.emu.it	600/31
	600/32
	600/33
	600/34
	600/35
	600/36
	600/37
	600/38
	600/39
	600/40
	600/41
	600/42
	600/43
	600/48
600/49	
CAT. D Visitare il nostro sito web www.emu.it —Visit our website www.emu.it	600/27
	900/16
	600/07
	600/14
CAT. C Visitare il nostro sito web www.emu.it —Visit our website www.emu.it	600/16
	600/18
CAT. B Visitare il nostro sito web www.emu.it —Visit our website www.emu.it	600/11
CON TESSUTO CLIENTE—WITH CUSTOMER'S FABRIC	
FABBISOGNO TESSUTO (cm)—FABRIC REQUIRED (cm)	C/9042132x65



APERRO

Design by Martin Drechsel



Scansiona e scopri i progetti.
Scan and discover the projects.



1300
Sedia
Chair



Fissaggio a scomparsa del cuscino tramite laccetti.
Invisible cushion fastening with hidden laces.

1301
Poltroncina
Armchair



Sofisticato e minimale design realizzato con tondini sagomati per garantire comfort ed ergonomia.
Collection of seats featured by a sophisticated and essential design made with shaped bars that ensure comfort and ergonomics.

1303
Sgabello
Barstool



Saldature a MIG e saldobrasatura nella parte visibile dei tondini.
MIG welding and braze welding in the visible part of the bars.

PRODOTTI—PRODUCTS

Codice/Code Tipologia/Typology	Disegno/Drawing	Info	TEST
1300 Sedia Chair W50 - D52 - H78 Kg 5,4			EN581-1/ EN581-2
1301 Poltroncina Armchair W55,5 - D52 - H78 Kg 5,9			EN581-1/ EN581-2
1303 Sgabello Barstool W53 - D55 - H101 Kg 7,0			

COLORI STRUTTURA—FRAME COLORS

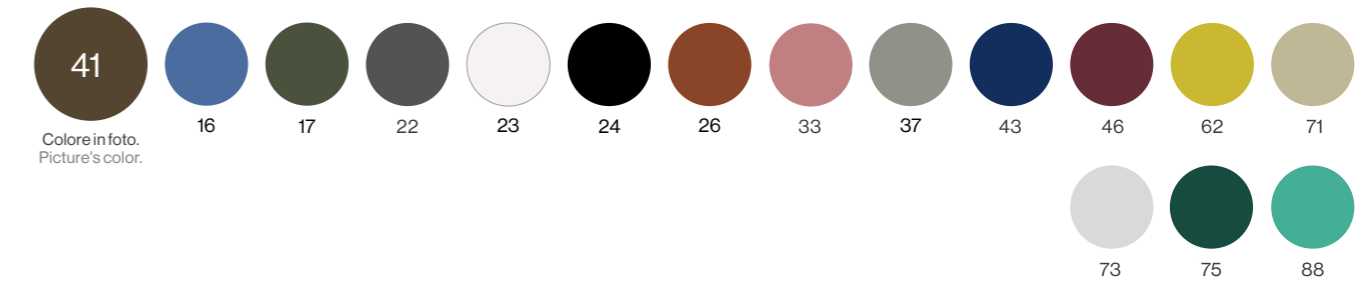

CUSCINI—CUSHIONS

Codice/Code Tipologia/Typology	Colori tessuto Fabric colors	Categoria tessuto Fabric category
C/1300 Cuscino seduta Seat cushion x cod. 1300, 1301, 1303 W43 - D40 - H2,5 Kg 0,22	700/4	Tessuti Basic Basic Fabrics
	700/10	
	700/13	
	700/32	
	700/34	Tessuti Standard Standard Fabrics
	900/02	
	900/05	
	900/07	
	900/08	
	900/09*	
	900/71	
	900/75	
	900/77	

* Cuscino visibile in foto—Cushion in the picture

COMBINAZIONI CONSIGLIATE—SUGGESTED MATCHINGS



DARWIN
Cod. 525
Tavolo abbattibile 2 posti
2 seats collapsible table
PAG. 196



NOVA
Cod. 854
Tavolo rettangolare 4/6 posti
4/6 seats rectangular table
PAG. 160



NOVA
Cod. 890
Tavolo alto quadrato 2 posti
2 seats counter square table
PAG. 162



314
Sedia Pieghevole
Folding chair



Pieghevole, di dimensioni compatte, consente un facile rimessaggio serale e invernale in utilizzo contract.
Foldable and compact, it allows easy storage in the evening and winter, for contract environments.

3513
2 sedie 314 + 1 tavolo 334
2 chairs 314 + 1 table 334

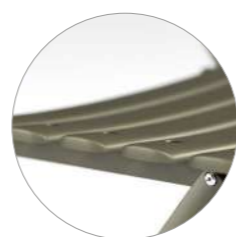

Stecche in lamiera di acciaio zincata a caldo e imbutita. Le stecche sono sagomate per aumentare il comfort alla seduta.
Deep-drawn slats in hot-dip zincated steel sheet. The slats are shaped to increase seat comfort.

PRODOTTI—PRODUCTS

Codice/Code Tipologia/Typology	Disegno/Drawing	Info
-----------------------------------	-----------------	------

314
Sedia pieghevole
Folding chair
W42,5 - D43 - H81
Kg 4,8

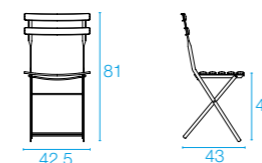

3513
2 sedie 314 + 1 tavolo 334
2 chairs 314 + 1 table 334



Kg 17,7

COLORI STRUTTURA—FRAME COLORS

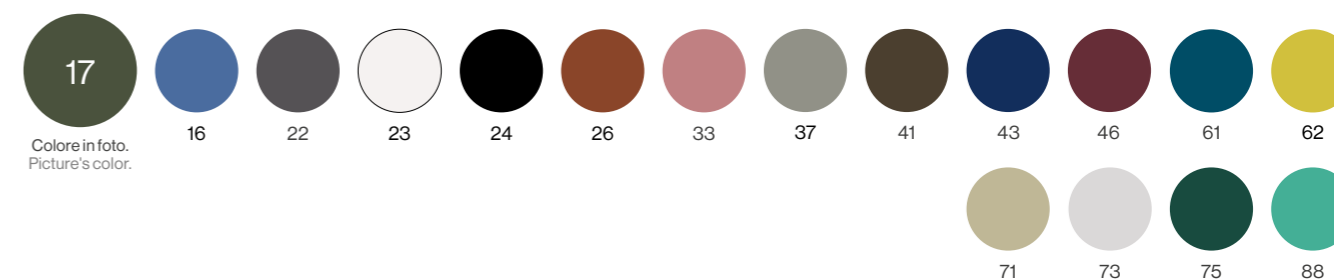

CUSCINI—CUSHIONS

Codice/Code Tipologia/Typology	Colori tessuto Fabric colors	Categoria tessuto Fabric category
C/717 Cuscino magnetico poliestere rettangolare Polyester rectangular magnetic cushion x cod. 314 W40 - D28 - H1,5 Kg 0,18	500/32 500/33 500/34 500/35 500/36	Tessuti Cuscini Contract Contract Cushions Fabrics



ALTRI PRODOTTI IN COLLEZIONE—OTHER COLLECTION'S PRODUCTS



ARC EN CIEL
Cod. 334
Tavolo pieghevole 2 posti
2 seats folding table
PAG. 150



ARC EN CIEL
Cod. 331
Tavolo pieghevole 4 posti
4 seats folding table
PAG. 150



ARC EN CIEL
Cod. 346
Tavolo pieghevole 2/4 posti
2/4 seats folding table
PAG. 150

PLUS

• Rivetti in acciaio inossidabile che diminuiscono il rischio di corrosione, ruggine e deterioramento da agenti atmosferici.—Stainless steel rivets that reduce the risk of corrosion, rust and deterioration due to weather conditions.
• Cuscino magnetico C/717 in abbinamento, stabile nella seduta e facile da rimuovere.
C/717 matching magnetic cushion, stable on the seat and easy to remove.



Scansiona e scopri i progetti.
Scan and discover the projects.

3413
Poltroncina
Armchair



Seduta e schienale in lamiera zincata a caldo forata effetto finto intreccio.
Seat and backrest in hot-dip zincated sheet with simulated woven wire mesh.



Fissaggio cuscino con lacci.
Cushion fastening with laces.

PRODOTTI—PRODUCTS

Codice/Code Tipologia/Typology	Disegno/Drawing	Info
-----------------------------------	-----------------	------

3413

Poltroncina
Armchair
W59 - D63 - H90
Kg 6,4

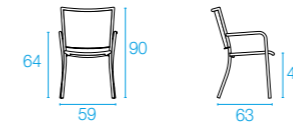

COLORI STRUTTURA—FRAME COLORS

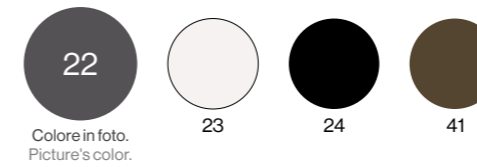

CUSCINI—CUSHIONS

Codice/Code Tipologia/Typology	Colori tessuto Fabric colors	Categoria tessuto Fabric category
C/3400 Cuscino seduta acrilico Acrylic seat cushion x cod. 3413 W40/45 - D44 - H6 Kg 0,37	700/4	Tessuti Basic Basic Fabrics
	700/10	
	700/13	
	700/32*	
	700/34	



* Cuscino visibile in foto—Cushion in the picture

ALTRI PRODOTTI IN COLLEZIONE—OTHER COLLECTION'S PRODUCTS



ATHENA
Cod. 3418
Tavolo basso
Coffee table
PAG. 278



ATHENA
Cod. 3425P+3429B
Tavolo allungabile
8+2/4 posti
8+2/4 seats
extendible table
PAG. 152



ATHENA
Cod. 3428P+3429B
Tavolo allungabile
6+2 posti
6+2 seats
extendible table
PAG. 152

PLUS

- Tubo in acciaio cataforizzato e verniciato.—Cataphorised and painted steel pipe.
- Lamiera saldata a proiezione per una maggiore precisione estetica.

Spot welded sheet for greater aesthetic precision.

- C/3400 cuscino seduta, C/3416 e C/3417 cuscino seduta e schienale sfoderabili. Imbottitura in resinato e poliuretano espanso.—C/3400 seat cushion, C/3416 and C/3417 seat and back cushion are cover remobile. Expanded polyurethane inner padding.

ATHENA

Design by EMU D&S Lab



Scansiona e scopri i progetti.
Scan and discover the projects.

3416
Poltrona
Lounge chair



* Cuscino visibile in foto 700/12 Bianco—Cushion in the picture 700/12 White
** Cover cod. FC/1216 disponibile come accessorio—Cover cod. FC/1216 available as accessory

3417
Divano 2 posti
2-Seater sofa



* Cuscino visibile in foto 700/12 Bianco—Cushion in the picture 700/12 White
** Cover cod. FC/1217 disponibile come accessorio—Cover cod. FC/1217 available as accessory

PRODOTTI—PRODUCTS



Codice/Code Tipologia/Typology	Disegno/Drawing	Info
-----------------------------------	-----------------	------

3416

Poltrona
Lounge chair
W74 - D78 - H78
Kg 9,1

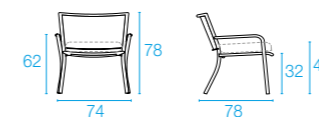

3417

Divano 2 posti
2-Seater sofa
W134 - D78 - H78
Kg 13,9

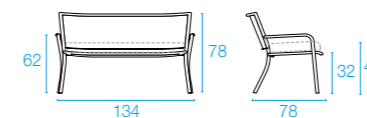

COLORI STRUTTURA—FRAME COLORS

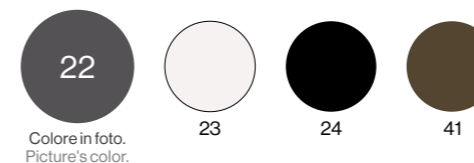

CUSCINI—CUSHIONS

Codice/Code Tipologia/Typology	Colori tessuto Fabric colors	Categoria tessuto Fabric category					
C/3416 Cuscino seduta e schienale acrilico Acrylic seat and back cushion x cod. 3416 W50/63 - D60 - H10 W54/60 - D44 - H10 Kg 2,15	<table border="1"> <tr><td>700/4</td></tr> <tr><td>700/10</td></tr> <tr><td>700/13</td></tr> <tr><td>700/32*</td></tr> <tr><td>700/34</td></tr> </table>	700/4	700/10	700/13	700/32*	700/34	Tessuti Basic Basic Fabrics
700/4							
700/10							
700/13							
700/32*							
700/34							
C/3417 Cuscino seduta e schienale acrilico Acrylic seat and back cushion x cod. 3417 W108/122 - D58 - H12 W108/122 - D45 - H9 Kg 4,3	<table border="1"> <tr><td>700/4</td></tr> <tr><td>700/10</td></tr> <tr><td>700/13</td></tr> <tr><td>700/32*</td></tr> <tr><td>700/34</td></tr> </table>	700/4	700/10	700/13	700/32*	700/34	Tessuti Basic Basic Fabrics
700/4							
700/10							
700/13							
700/32*							
700/34							
C/701 Cuscino decorativo Decorative cushion x cod. 3416, 3417 W40 - D40 - H15 Kg 0,7		Vedi pg. 369 Look at pg. 369					
C/705 Cuscino decorativo Decorative cushion x cod. 3416, 3417 W45 - D35 - H15 Kg 0,7							
C/706 Cuscino decorativo Decorative cushion x cod. 3416, 3417 W60 - D40 - H20 Kg 0,9							
Tessuti Basic (Vedi riepilogo pg. 369) Tessuti Standard (Vedi riepilogo pg. 369) Tessuti Exclusive (Vedi riepilogo pg. 369) Basic Fabrics (Look at pg. 369) Standard Fabrics (Look at pg. 369) Exclusive Fabrics (Look at pg. 369)							



Scansiona e scopri i progetti.
Scan and discover the projects.



556
Sedia
Chair



Comfort delle sedute grazie alla sua forma concava realizzata dallo stampaggio della lamiera di sedile.
Seat comfort thanks to its concave shape created by molding the seat sheet metal.

557
Poltroncina
Armchair



Ergonomia dello schienale realizzata tramite sagomatura della lamiera di schienale.
Ergonomics of the backrest achieved by shaping the backrest sheet metal.

558
Sgabello
Barstool



Lamiera con pattern esclusivo EMU.
Exclusive EMU pattern of expandend metal sheet.

PRODOTTI—PRODUCTS

Codice/Code Tipologia/Typology	Disegno/Drawing	Info	TEST
-----------------------------------	-----------------	------	------

556
Sedia
Chair
W52,5 - D56,5 - H77
Kg 6,0

557
Poltroncina
Armchair
W60 - D55 - H77
Kg 6,6

559
Sgabello
Barstool
W58 - D52 - H102
Kg 7,3

COLORI STRUTTURA—FRAME COLORS

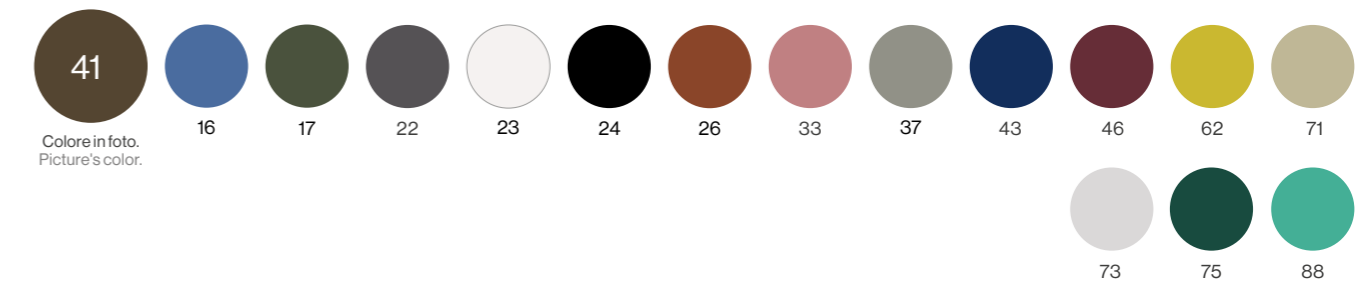

CUSCINI—CUSHIONS

Codice/Code Tipologia/Typology	Colori tessuto Fabric colors	Categoria tessuto Fabric category
C/556 Cuscino seduta poliester Polyester seat cushion x cod. 556, 557, 559 W40 - D39 - H1,5 Kg 0,2	<ul style="list-style-type: none"> 500/32 500/33 500/34 500/35 500/36 	Tessuti Cuscini Contract Contract Cushions Fabrics

COMBINAZIONI CONSIGLIATE—SUGGESTED MATCHINGS



DARWIN
Cod. 525
Tavolo abbattibile 2 posti
2 seats collapsible table
PAG. 196



ROUND
Cod. 471
Tavolo quadrato 2 posti
2 seats square table
PAG. 210



NOVA
Cod. 890
Tavolo alto quadrato 2 posti
2 seats counter square table
PAG. 162

PLUS

- Ridotto ingombro delle gambe a terra e della profondità dello schienale, che rende questa collezione particolarmente performante negli spazi contract.—Reduced space of the legs on the floor and of backrest depth, which makes this collection highly performant in contract uses.
- Saldature MIG di alta precisione dei bordi perimetrali delle lamiere di sedile e schienale sulla struttura.
High precision MIG welding of the perimetreal edges of seat and back sheets on the frame.
- Design dal gusto classico ma dal look slanciato e minimal.
Design with a classic taste, but with a slim and minimal look.
- Ampia gamma colori.—Wide colour range.
- Impilabilità fino a 8 pezzi.—Stackable up to 8 pieces.



Scansiona e scopri i progetti.
Scan and discover the projects.

930
Sedia
Chair

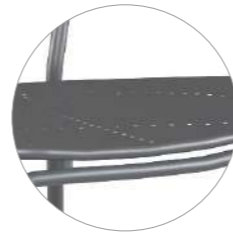

Sedile in lamiera di acciaio zincata a caldo con fori decorativi che facilitano lo scolo dell'acqua.
Seat made of hot-dip zincated steel sheet with decorative holes allowing water drainage.

931
Poltroncina
Armchair



Il tondino di acciaio zincato a caldo viene piegato conferendo allo schienale di questa seduta un disegno caratterizzante.
Hot-dip zincated bars is bended creating this featuring backrest shape.

COMBINAZIONI CONSIGLIATE—SUGGESTED MATCHINGS



PIGALLE
Cod. 906
Tavolo tondo 2/4 posti
2/4 seats round table
PAG. 164



PIGALLE
Cod. 907
Tavolo pieghevole 2/4 posti
2/4 seats folding table
PAG. 164



PIGALLE
Cod. 903
Tavolo pieghevole 4/6 posti
4/6 seats folding table
PAG. 165

PRODOTTI—PRODUCTS



Codice/Code Tipologia/Typology	Disegno/Drawing	Info	TEST
-----------------------------------	-----------------	------	------

930

Sedia
Chair
W54 - D54 - H87
Kg 5,8

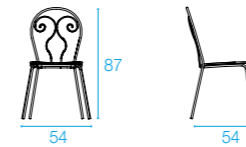

EN581-1 / EN581-2

931

Poltroncina
Armchair
W54 - D54 - H87
Kg 6,6

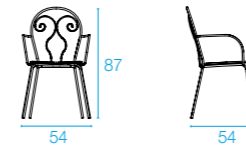

EN581-1 / EN581-2

COLORI STRUTTURA—FRAME COLORS

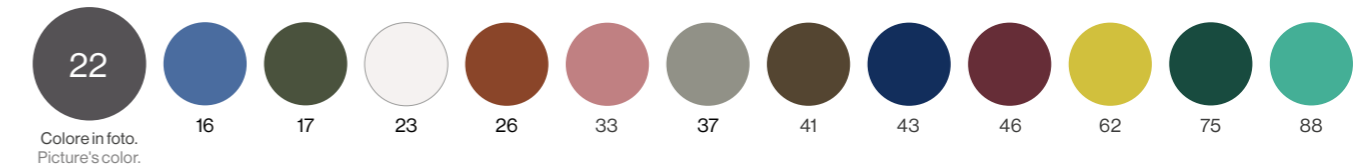

CUSCINI—CUSHIONS

Codice/Code Tipologia/Typology	Colori tessuto Fabric colors	Categoria tessuto Fabric category
C/715 Cuscino magnetico poliestere tondo Polyester round magnetic cushion x cod. 930, 931 ø38 - H1,5 Kg 0,17	500/32* 500/33 500/34 500/35 500/36	Tessuti Cuscini Contract Contract Cushions Fabrics
C/704 Cuscino EMU acrilico tondo Acrylic EMU round cushion x cod. 930, 931 ø38,5 - H2 Kg 0,13	700/4 700/10 700/13 700/32* 700/34	Tessuti Basic Basic Fabrics

* Cuscino visibile in foto—Cushion in the picture

PLUS

• Struttura in tubo di acciaio diam. 14mm.—14mm diameter steel pipe frame.
• Seduta dal design classico intramontabile che ben si presta ad arredare bistrot e ristoranti nei centri città.
This timeless design well furnishes bistrot and restaurants in town centres.

CAROUSEL

Design by Sebastian Herkner



Scansiona e scopri i progetti.
Scan and discover the projects.

1212
Poltroncina
Alu-corda
intreccio fitto
Alu-thick
twist rope
armchair



Colore in foto.
Picture's color.

* Cuscino visibile in foto 900/77 Grigio—Cushion in the picture 900/77 Grey

1213
Poltroncina
Alu-corda
intreccio quadrato
Alu-square
twist rope
armchair



Colore in foto.
Picture's color.

* Cuscino visibile in foto 900/75 Ebano—Cushion in the picture 900/75 Ebony

1214
Poltroncina
Alu-corda
piatta
Alu-flat rope
armchair



Colore in foto.
Picture's color.

* Cuscino visibile in foto 900/71 Bianco—Cushion in the picture 900/71 White

PRODOTTI—PRODUCTS

Codice/Code Tipologia/Typology	Disegno/Drawing	Info	TEST
1212 Poltroncina Alu-corda intreccio fitto Alu-thick twist rope armchair W61,5 - D52 - H77 Kg 9,5			
1213 Poltroncina Alu-corda intreccio quadrato Alu-square twist rope armchair W61,5 - D52 - H77 Kg 8,1			
1214 Poltroncina Alu-corda piatta Alu-flat rope armchair W61,5 - D52 - H77 Kg 8,3			EN581-1/EN581-2

COLORI STRUTTURA/SCHIENALE—FRAME/BACK COLORS

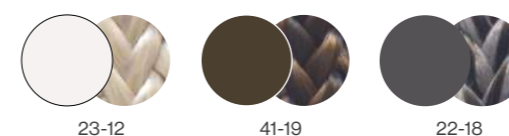

CUSCINI—CUSHIONS

Codice/Code Tipologia/Typology	Colori tessuto Fabric colors	Categoria tessuto Fabric category
C/1211 Cuscino seduta Seat cushion x cod. 1212, 1213, 1214 W47 - D44 - H7 Kg 0,52		Vedi pg. 42 Look at pg. 42
FC/1210 Cover x cod. 1212, 1213, 1214		

PLUS

- La poltroncina dining è disponibile in tre versioni di intreccio.
The dining armchair is available in three versions of weaving.
- Il sedile, costituito da una lamiera imbutita in lega di alluminio, è fissato alla struttura di alluminio tramite rivettatura.—The deep-drawn seat in aluminium alloy is fixed to the aluminium frame by riveting.
- La struttura dello schienale è in acciaio cataforizzato ed è il supporto su cui sono realizzati i vari intrecci decorativi.—The cataphorised backrest steel frame of the backrest supports the various decorative weaves.
- Tutte le saldature sono particolarmente curate e ripulite con un processo di molatura che conferisce un'estetica curata e definita.—All the welds are extremely finished thanks to a grinding process which gives a more refined aesthetic detail.
- Corda idrorepellente.—Water-repellent rope.
- Cuscino C/1211 sfoderabile disponibile in una vasta gamma di tessuti. Imbottitura interna in poliester e poliuretano espanso.—C/1211 removable cushion cover available in a wide range of fabrics. Polyester and expanded polyurethane inner padding.

CAROUSEL

Design by Sebastian Herkner



Scansiona e scopri i progetti.
Scan and discover the projects.

1216
Poltrona
Alu-corda
intreccio fitto
Alu-thick
twist rope
lounge chair



23-12
Colore in foto.
Picture's color.

* Cuscino visibile in foto 900/77 Grigio—Cushion in the picture 900/77 Grey

1217
Poltrona
Alu-corda
intreccio quadrato
Alu-square
twist rope
lounge chair



41-19
Colore in foto.
Picture's color.

* Cuscino visibile in foto 900/75 Ebano—Cushion in the picture 900/75 Ebony

1218
Poltrona
Alu-corda
piatta
Alu-flat rope
lounge chair



22-18
Colore in foto.
Picture's color.

* Cuscino visibile in foto 900/71 Bianco—Cushion in the picture 900/71 White



Il tubolare di alluminio della struttura a cavalletto è modellato tridimensionalmente per offrire un raffinato design svolgendo sia la funzione portante che quella di comodo bracciolo. Saldatura a TIG delle varie componenti che conferisce maggiore resistenza ed un miglior livello estetico. The aluminium pipe of the easel frame is three-dimensionally modeled and offers an elegant design acting as structural component as well as comfortable armrest. TIG welding of the elements for a better resistance and aesthetic.

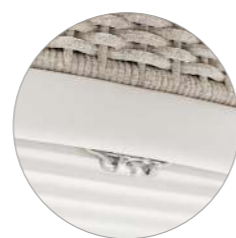

Fissaggio cuscino con elastico e gancetti. Cushion fastening with rubber band and hooks.

PRODOTTI—PRODUCTS

Codice/Code Tipologia/Typology	Disegno/Drawing	Info	TEST
1216 Poltrona Alu-corda intreccio fitto Alu-thick twist rope lounge chair W74 - D73 - H73,5 Kg 13,8			
1217 Poltrona Alu-corda intreccio quadrato Alu-square twist rope lounge chair W74 - D73 - H73,5 Kg 11,4			
1218 Poltrona Alu-corda piatta Alu-flat rope lounge chair W74 - D73 - H73,5 Kg 10,6			EN581-1 / EN581-2

COLORI STRUTTURA/SCHIENALE—FRAME/BACK COLORS

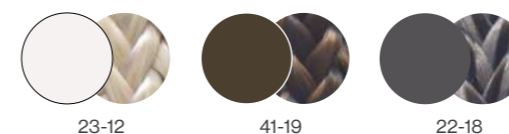

CUSCINI—CUSHIONS

Codice/Code Tipologia/Typology	Colori tessuto Fabric colors	Categoria tessuto Fabric category
C/1215 Cuscino seduta—Seat cushion x cod. 1216, 1217, 1218 W58 - D57 - H10 Kg 1,24		Tessuti Basic (Vedi riepilogo pg. 42) Tessuti Standard (Vedi riepilogo pg. 42)* Tessuti Exclusive (Vedi riepilogo pg. 42) Basic Fabrics (Look at pg. 42) Standard Fabrics (Look at pg. 42)* Exclusive Fabrics (Look at pg. 42)
C/701 Cuscino decorativo Decorative cushion x cod. 1216, 1217, 1218, 1219 W40 - D40 - H15 Kg 0,7		Tessuti Basic (Vedi riepilogo pg. 369) Tessuti Standard (Vedi riepilogo pg. 369) Tessuti Exclusive (Vedi riepilogo pg. 369) Basic Fabrics (Look at pg. 369) Standard Fabrics (Look at pg. 369) Exclusive Fabrics (Look at pg. 369)
C/705 Cuscino decorativo Decorative cushion x cod. 1216, 1217, 1218, 1219 W45 - D35 - H15 Kg 0,7		
C/706 Cuscino decorativo Decorative cushion x cod. 1216, 1217, 1218, 1219 W60 - D40 - H20 Kg 0,9		
FC/1216 Cover x cod. 1216, 1217, 1218		

CAROUSEL

Design by Sebastian Herkner



Scansiona e scopri i progetti.
Scan and discover the projects.

1219
Divano
Alu-corda
intreccio fitto
Alu-thick
twist rope
sofa



Colore in foto.
Picture's color.

* Cuscino visibile in foto 900/77 Grigio—Cushion in the picture 900/77 Grey

1222
Pouf



Colore in foto.
Picture's color.

* Cuscino visibile in foto 900/77 Grigio—Cushion in the picture 900/77 Grey

ALTRI PRODOTTI IN COLLEZIONE—OTHER COLLECTION'S PRODUCTS

40



CAROUSEL
Cod. 1223
Tavolo basso quadrato Alu-corda intreccio fitto
Alu-thick twist rope square coffee table
PAG. 284



CAROUSEL
Cod. 1224
Tavolo basso rettangolare Alu-corda intreccio fitto
Alu-thick twist rope rectangular coffee table
PAG. 284

PRODOTTI—PRODUCTS



Codice/Code Tipologia/Typology	Disegno/Drawing	Info
-----------------------------------	-----------------	------

1219

Divano Alu-corda intreccio fitto
Alu-thick twist rope sofa
W155 - D71 - H73
Kg 22,3

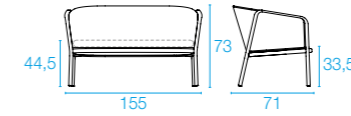

1222

Pouf
W62 - D44,5 - H33
Kg 4,0

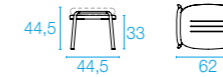

COLORI STRUTTURA/SCHIENALE X COD. 1219—FRAME/BACK COLORS X COD. 1219

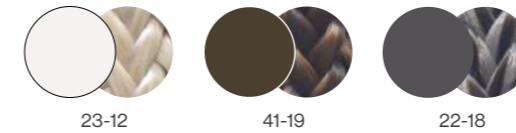

COLORI STRUTTURA X COD. 1222—FRAME COLORS X COD. 1222

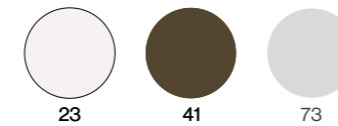

CUSCINI—CUSHIONS

Codice/Code Tipologia/Typology	Colori tessuto Fabric colors	Categoria tessuto Fabric category
C/1219 Cuscino seduta Seat cushion x cod. 1219 W145 - D62 - H11 Kg 2,8		Vedi pg. 42 Look at pg. 42 Tessuti Basic (Vedi riepilogo pg. 42) Tessuti Standard (Vedi riepilogo pg. 42)* Tessuti Exclusive (Vedi riepilogo pg. 42) Basic Fabrics (Look at pg. 42) Standard Fabrics (Look at pg. 42)* Exclusive Fabrics (Look at pg. 42)
C/1222 Cuscino seduta Seat cushion x cod. 1222 W53 - D44 - H10 Kg 0,74		
FC/1219 Cover x cod. 1219		

PLUS

- L'intera collezione, per il suo material mix, risulta particolarmente adatta in ambienti marini e su imbarcazioni.
The whole collection, thanks to the material mix, is particularly suitable for marine environments and boats.
- Il divano è disponibile solo nella versione intreccio fitto.—The sofa is only available in the thick twist version.
- Corda idrorepellente.—Water-repellent rope.
- C/1219 e C/1222 cuscini sfoderabili disponibili in una vasta gamma di tessuti. Imbottitura interna in poliester e poliuretano espanso.—C/1219 and C/1222 removable cushions cover in a wide range of fabrics. Polyester and expanded polyurethane inner padding.

41



TESSUTI CUSCINI — CUSHION FABRICS C/1211 - C/1215 - C/1219 - C/1222

Composizione/Categoria tessuti Composition/Fabrics category	Colori Colors
--	------------------

TESSUTI BASIC — BASIC FABRICS

Acrilico — Acrylic

700/4
700/10
700/13
700/32
700/34

TESSUTI STANDARD — STANDARD FABRICS

88% Acrilico, 12% Poliestere — 88% Acrylic, 12% Polyester

Acrilico — Acrylic

900/02
900/05
900/07
900/08
900/09
900/18
900/71
900/75
900/77

TESSUTI EXCLUSIVE — EXCLUSIVE FABRICS

CAT. E

Visitare il nostro sito web www.emu.it — Visit our website www.emu.it

CAT. D

Visitare il nostro sito web www.emu.it — Visit our website www.emu.it

CAT. C

Visitare il nostro sito web www.emu.it — Visit our website www.emu.it

CAT. B

Visitare il nostro sito web www.emu.it — Visit our website www.emu.it

CON TESSUTO CLIENTE — WITH CUSTOMER'S FABRIC

FABBISOGNO TESSUTO (cm) — FABRIC REQUIRED (cm) C/1211 132x60, C/1215 132x100, C/1219 132x200, C/1222 132x75

600/31
600/32
600/33
600/34
600/35
600/36
600/37
600/38
600/39
600/40
600/41
600/42
600/43
600/48
600/49
600/27
900/16
600/07
600/14
600/16
600/18
600/11





Scansiona e scopri i progetti.
Scan and discover the projects.



974

Poltroncina regista
Director's armchair



Apertura pieghevole con bloccaggio di sicurezza in acciaio inossidabile lucido.
Folding opening with polished stainless steel safety locking.



La sedia piegata rimane in piedi da sola occupando pochissimo spazio e consente un facile rimessaggio.

When folded, the chair is self-standing suitable to be easily stored in a little space.

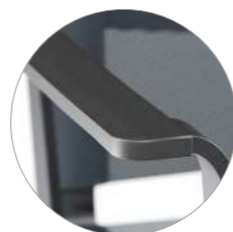

Bracciolo effetto legno in ABS.
Wood-like ABS armrest.

975

Pouf / poggiatesta
pieghevole
Folding
pouf / footstool



Doppia cucitura del telo sedile e schienale per una maggiore resistenza alle sollecitazioni in uso.
Double stitching of seat and backrest cloth for a greater resistance to stress in use.

PRODOTTI—PRODUCTS

Codice/Code Tipologia/Typology	Disegno/Drawing	Info	TEST
-----------------------------------	-----------------	------	------

974

Poltroncina regista
Director's armchair
W64 - D50 - H85
Kg 5,7

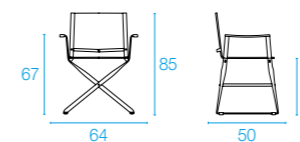

975

Pouf / poggiatesta
pieghevole
Folding
pouf / footstool
W42 - D48 - H38
Kg 2,9

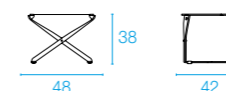

EN581-1 / EN581-2

COLORI STRUTTURA/SEDUTA E SCHIENALE/BRACCIOLI X COD. 974
FRAME/SEAT AND BACKREST/ARMRESTS COLORS X COD. 974

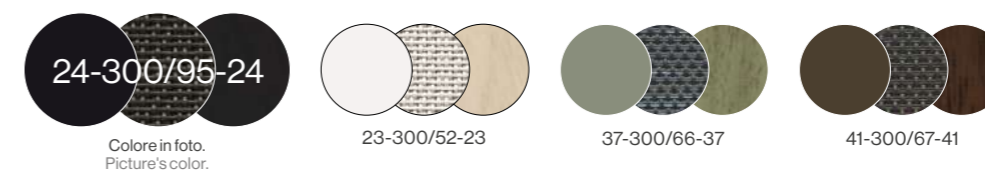

COLORI STRUTTURA/SEDUTA X COD. 975 — FRAME/SEAT COLORS X COD. 975

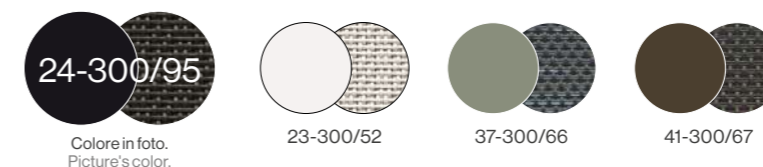

Le immagini dei colori sono a scopo illustrativo. Per vedere la trama degli EMU-TEX, consultare pg. 379.
All picture's colors are for illustration purposes only. Look at pg. 379 to see the texture of the EMU-TEX.

COMBINAZIONI CONSIGLIATE—SUGGESTED MATCHINGS



GRACE
Cod. 285+288
Tavolo bordo quadrato
abbattibile 2 posti
2 seats collapsible square
edge table
PAG. 202



SHINE
Cod. 254+256
Tavolo 2/4 posti con piano
in HPL
2/4 seats table with HPL top
PAG. 214



TERRAMARE
Cod. 738
Tavolo rettangolare 8 posti
8 seats rectangular table
PAG. 178

PLUS

• Design trasversale e ben combinabile ad altre collezioni di tavoli o elementi lounge in catalogo.

Design well suitable to be combined with tables or lounge products of other collections.

• Struttura in piatto di alluminio modellato che crea una piacevole forma estetica e conferisce grande leggerezza.

The flat aluminium pipe of the frame is shaped for a pleasant look and great lightness in terms of weight.

CODE

Design by EMU D&S Lab



Scansiona e scopri i progetti.
Scan and discover the projects.



679
Sedia
Chair



Concavità dello schienale realizzata tramite stampaggio che conferisce alla seduta la sua forma avvolgente.
Concavity of the backrest made by molding which gives the seat its enveloping shape.



Esclusiva ergonomia tramite stampaggio della concavità interna della lamiera di sedile che conferisce un'ulteriore inclinazione e comfort.
Exclusive ergonomics through molding of the internal concavity of the seat sheet which provides extra inclination and comfort.



Sagomatura del tubo inferiore di struttura per inserimento di particolari per assorbire il rumore in uso.
Shaping of the lower frame pipe for the insertion of noise-absorbing details.

PRODOTTI—PRODUCTS

Codice/Code Tipologia/Typology	Disegno/Drawing	Info
-----------------------------------	-----------------	------

679

Sedia
Chair
W48 - D54 - H81
Kg 6,4

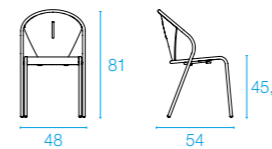

COLORI STRUTTURA—FRAME COLORS

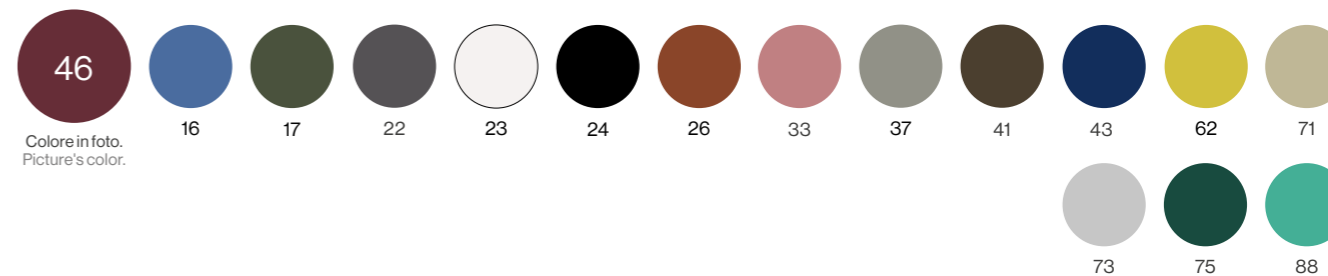

COMBINAZIONI CONSIGLIATE—SUGGESTED MATCHINGS

46



TABLE SYSTEM
Cod. 1156
Tavolo bordo tondo
5/6 posti
5/6 seats round
edge table
PAG. 216



PLUS4
Cod. 3485
Tavolo allungabile
6+4 posti
6+4 seats
extensible table
PAG. 166



NOVA
Cod. 859
Tavolo quadrato impilabile
4 posti
4 seats stackable
square table
PAG. 160

PLUS

- Piega della lamiera di sedile nella parte anteriore per un miglior comfort in uso.
The front part of the seat is folded for more comfort in use.
- Saldature con tecnica MIG per un'elevata resistenza meccanica.—MIG welding for high static load resistance.
- Schienale e sedile in lamiera di acciaio zincata a caldo.—Backrest and seat in pre hot-dip zincated steel sheet.
- Ridotto ingombro delle gambe a terra che rende la seduta particolarmente performante in ambienti contract.
Its minimum volume of the legs on the ground makes this chair highly performing in contract environments.
- I sottopiedi in PVC permettono di minimizzare la trasmissione di vibrazioni e conseguente risonanza.
The PVC feet allow minimizing the transmission of vibrations and consequent resonance.
- Impilabilità fino a 6 pezzi.—Stackable up to 6 pieces.
- Ispirazione stile industriale.—Industrial style inspiration.

47

COLLIER

Design by LCM Marin Design Studio



Scansiona e scopri i progetti.
Scan and discover the projects.



1350
Sedia
Chair



Fregio decorativo in ottone, tratto caratteristico della collezione creato da stampo personalizzato per realizzare un motivo decorativo unico, ripetuto anche sulla crociera delle gambe. Decorative brass frieze as characteristic feature of the collection created by personalized mould, also repeated on the cross of the legs.

1351
Poltroncina
Armchair



Sistema di fissaggio di cuscino sedile e schienale tramite laccetti di tessuto. Cushion fastening system with fabric laces.



Curvatura del bracciolo che valorizza il design e il comfort in uso. Armrest final curve that enhance design and comfort in use.

PRODOTTI—PRODUCTS

Codice/Code Tipologia/Typology	Disegno/Drawing	Info	TEST
-----------------------------------	-----------------	------	------

1350

Sedia
Chair
W52 - D64 - H90
Kg 9,0

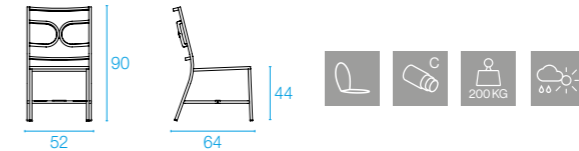

1351

Poltroncina
Armchair
W62 - D64 - H90
Kg 11,4

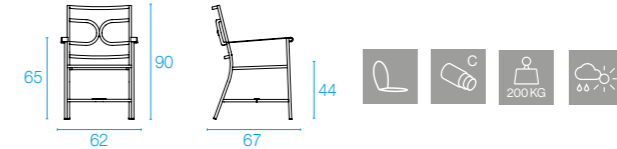

COLORI STRUTTURA—FRAME COLORS

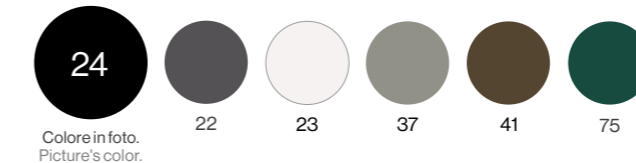

CUSCINI—CUSHIONS

Codice/Code Tipologia/Typology	Colori tessuto Fabric colors	Categoria tessuto Fabric category
C/1250 Cuscino seduta e schienale Seat and back cushion x cod. 1350, 1351 W48 - D45+51 - H6 Kg 0,7	700/4*	Tessuti Basic Basic Fabrics
	700/10	
	700/13	
	700/32	
	700/34	
C/1350 Cuscino seduta—Seat cushion x cod. 1350, 1351 W48,5 - D49 - H6 Kg 0,8	Vedi pg. 52 Look at pg. 52	Tessuti Basic (Vedi riepilogo pg. 52) Tessuti Standard (Vedi riepilogo pg. 52)* Tessuti Exclusive (Vedi riepilogo pg. 52) Basic Fabrics (Look at pg. 52) Standard Fabrics (Look at pg. 52)* Exclusive Fabrics (Look at pg. 52)
	C/1351 Cuscino schienale—Back cushion x cod. 1350, 1351 W51 - D47 - H4,5 Kg 0,7	

* Cuscino visibile in foto—Cushion in the picture

PLUS

- Design classico contemporaneo per le destinazioni d'uso del segmento Hospitality quali alberghi e ristoranti di alto livello.— Contemporary classic design for uses in the hospitality segment such as high-level hotels and restaurants.
- Comfort delle sedute grazie alle dimensioni generose ma proporzionate. Comfort of the seats thanks to the generous but proportionate dimensions.
- La lamiera di sedile in acciaio zincata a caldo dal pattern decorativo connotante è saldata a proiezione sulla struttura e anch'essa molata finemente per rimuovere ogni imperfezione. The hot-dip zincated steel seat sheet with a distinctive decorative pattern is projection welded onto the frame and also finely brushed to remove any imperfections.
- Possibile utilizzo delle sedute senza cuscineria.— Possible use of seats without cushions.
- Possibilità di utilizzare sia il solo cuscino sedile schienale o cuscino sedile e schienale. Possibility of using both seat cushion and seat and back one.
- Sottopiedi in nylon.— Nylon feet.

ALTRI PRODOTTI IN COLLEZIONE—OTHER COLLECTION'S PRODUCTS

48



COLLIER
Cod. 1356+1340
Tavolo basso con piano in lamiera
Coffee table with steel sheet top
PAG. 286



COLLIER
Cod. 1358+1344
Tavolo tondo 6/7 posti
con piano in lamiera
6/7 seats round table
with steel sheet top
PAG. 192



COLLIER
Cod. 1357+1342
Tavolo quadrato 4 posti
4 seats square table
PAG. 192

49

COLLIER

Design by LCM Marin Design Studio



Scansiona e scopri i progetti.
Scan and discover the projects.

1352
Poltrona
Lounge chair



Fregio decorativo in ottone, tratto caratteristico della collezione creato da stampo personalizzato per realizzare un motivo decorativo unico, ripetuto anche sulla crociera delle gambe. Decorative brass frieze as characteristic feature of the collection created by personalized mould, also repeated on the cross of the legs.



Sistema di fissaggio di cuscino sedile e schienale tramite laccetti di tessuto. Cushion fastening system with fabric laces.



Curvatura del bracciolo che valorizza il design e il comfort in uso. Armrest final curve that enhance design and comfort in use.

PRODOTTI—PRODUCTS

Codice/Code Tipologia/Typology	Disegno/Drawing	Info	TEST
-----------------------------------	-----------------	------	------

1352

Poltrona
Lounge chair
W85 - D79 - H78,5
Kg 14,6

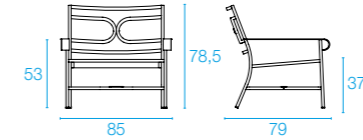

COLORI STRUTTURA—FRAME COLORS

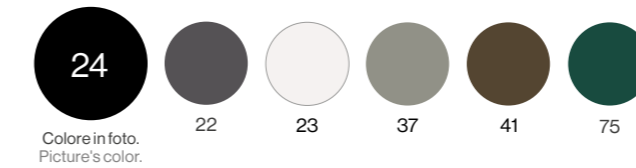

CUSCINI—CUSHIONS

Codice/Code Tipologia/Typology	Colori tessuto Fabric colors	Categoria tessuto Fabric category					
C/1252 Cuscino seduta e schienale Seat and back cushion x cod. 1352 W69 - D53+47 - H6 Kg 1,1		<table border="1"> <tr><td>700/4*</td></tr> <tr><td>700/10</td></tr> <tr><td>700/13</td></tr> <tr><td>700/32</td></tr> <tr><td>700/34</td></tr> </table> <p>Tessuti Basic Basic Fabrics</p>	700/4*	700/10	700/13	700/32	700/34
700/4*							
700/10							
700/13							
700/32							
700/34							
C/1352 Cuscino seduta—Seat cushion x cod. 1352 W70,5 - D57 - H7 Kg 1,1		<p>Vedi pg. 52 Look at pg. 52</p> <p>Tessuti Basic (Vedi riepilogo pg. 52) Tessuti Standard (Vedi riepilogo pg. 52)* Tessuti Exclusive (Vedi riepilogo pg. 52) Basic Fabrics (Look at pg. 52) Standard Fabrics (Look at pg. 52)* Exclusive Fabrics (Look at pg. 52)</p>					
C/1353 Cuscino schienale—Back cushion x cod. 1352 W73 - D43 - H5 Kg 0,8							
C/701 Cuscino decorativo Decorative cushion x cod. 487 W40 - D40 - H15 Kg 0,7		<p>Vedi pg. 369 Look at pg. 369</p> <p>Tessuti Basic (Vedi riepilogo pg. 369) Tessuti Standard (Vedi riepilogo pg. 369) Tessuti Exclusive (Vedi riepilogo pg. 369) Basic Fabrics (Look at pg. 369) Standard Fabrics (Look at pg. 369) Exclusive Fabrics (Look at pg. 369)</p>					
C/705 Cuscino decorativo Decorative cushion x cod. 487 W45 - D35 - H15 Kg 0,7							
C/706 Cuscino decorativo Decorative cushion x cod. 487 W60 - D40 - H20 Kg 0,9							

* Cuscino visibile in foto—Cushion in the picture

COLLIER

Design by LCM Marin Design Studio



Scansiona e scopri
i progetti.
Scan and discover
the projects.

TESSUTI CUSCINI — CUSHION FABRICS C/1350 - C/1351 - C/1352 - C/1353

Composizione/Categoria tessuti
Composition/Fabrics category

Colori
Colors

TESSUTI BASIC — BASIC FABRICS

Acrilico — Acrylic

700/4
700/10
700/13
700/32
700/34

TESSUTI STANDARD — STANDARD FABRICS

88% Acrilico, 12% Poliestere — 88% Acrylic, 12% Polyester

Acrilico — Acrylic

900/02
900/05
900/07
900/08
900/09
900/18
900/71
900/75
900/77

TESSUTI EXCLUSIVE — EXCLUSIVE FABRICS

CAT. E

Visitare il nostro sito web www.emu.it — Visit our website www.emu.it

CAT. D

Visitare il nostro sito web www.emu.it — Visit our website www.emu.it

CAT. C

Visitare il nostro sito web www.emu.it — Visit our website www.emu.it

CAT. B

Visitare il nostro sito web www.emu.it — Visit our website www.emu.it

CON TESSUTO CLIENTE — WITH CUSTOMER'S FABRIC

FABBISOGNO TESSUTO (cm) — FABRIC REQUIRED (cm)

C/1350 132x230, C/1351 132x230, C/1352 132x280, C/1353 132x280





Scansiona e scopri i progetti.
Scan and discover the projects.



1200
Sedia
Chair



Saldatura a ottone dei tondini decorativi e dei tubi dello schienale per un migliore effetto estetico.
Brass welding of decorative bars and backrest pipes for a better aesthetic look.

1201
Poltroncina
schienale
basso
Short back
armchair



La seduta in lamiera zincata a caldo è saldata a proiezione al tubo di struttura.
The hot-dip zinc plated seat sheet is spot welded to the frame pipe.

1202
Poltroncina
schienale alto
Tall back
armchair



Fissaggio cuscino con lacci.
Cushion fastening with laces.

PRODOTTI—PRODUCTS

Codice/Code Tipologia/Typology	Disegno/Drawing	Info	TEST
-----------------------------------	-----------------	------	------

1200

Sedia
Chair
W57 - D59,5 - H83,5
Kg 6,2

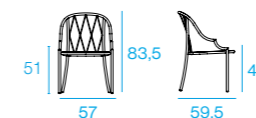

EN581-1/ EN581-2

1201

Poltroncina
schienale basso
Short back armchair
W57 - D59 - H83,5
Kg 6,2

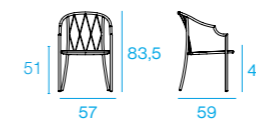

1202

Poltroncina
schienale alto
Tall back
armchair
W57 - D62 - H95
Kg 6,8

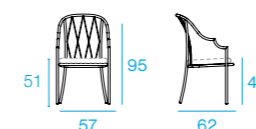

EN581-1/ EN581-2

COLORI STRUTTURA—FRAME COLORS

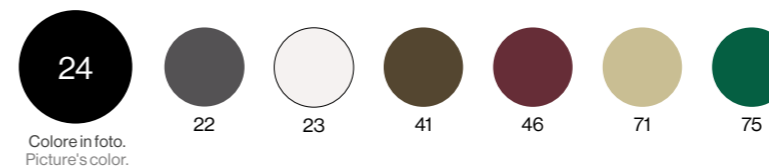

CUSCINI—CUSHIONS

Codice/Code Tipologia/Typology	Colori tessuto Fabric colors	Categoria tessuto Fabric category
C/1200 Cuscino seduta—Seat cushion x cod. 1200, 1201, 1202 W52 - D48 - H7 Kg 0,6		Tessuti Basic (Vedi riepilogo pg. 58) Tessuti Standard (Vedi riepilogo pg. 58)* Tessuti Exclusive (Vedi riepilogo pg. 58) Basic Fabrics (Look at pg. 58) Standard Fabrics (Look at pg. 58)* Exclusive Fabrics (Look at pg. 58)
C/1201 Cuscino schienale—Back cushion x cod. 1200, 1201, 1202 W32 - D35 - H2 Kg 0,2		

Vedi pg. 58
Look at pg. 58

*Cuscino visibile in foto 900/71 Bianco—Cushion in the picture 900/71 White

PLUS

• C/1200, C/1204, C/1205 e C/1206 cuscini sfoderabili, disponibili in una vasta gamma di tessuti. Imbottitura interna in poliuretano espanso.— C/1200, C/1204, C/1205 and C/1206 removable cushions cover in a wide range of fabrics. Expanded polyurethane inner padding.



Scansiona e scopri i progetti.
Scan and discover the projects.

1204
Poltrona
Lounge chair



* Cuscino visibile in foto 900/71 Bianco—Cushion in the picture 900/71 White

1205
Divano 2 posti
2-Seater sofa



* Cuscino visibile in foto 900/71 Bianco—Cushion in the picture 900/71 White



L'intreccio dei tondini saldati a proiezione è un elemento che caratterizza il design classico del prodotto.
The weave of spot welded bars is one of the specific features of this piece of classic design.

ALTRI PRODOTTI IN COLLEZIONE—OTHER COLLECTION'S PRODUCTS



COMO
Cod. 494+1207
Tavolo tondo 6/7 posti
6/7 seats round table
PAG. 194



COMO
Cod. 1208
Tavolo basso
Coffee table
PAG. 288

PRODOTTI—PRODUCTS



Codice/Code Tipologia/Typology	Disegno/Drawing	Info	TEST
-----------------------------------	-----------------	------	------

1204 Poltrona Lounge chair W78 - D76 - H79 Kg 8,8			EN581-1/EN581-2
---	--	--	-----------------

1205 Divano 2 posti 2-Seater sofa W155 - D76 - H79 Kg 16,5			EN581-1/EN581-2
--	--	--	-----------------

COLORI STRUTTURA—FRAME COLORS

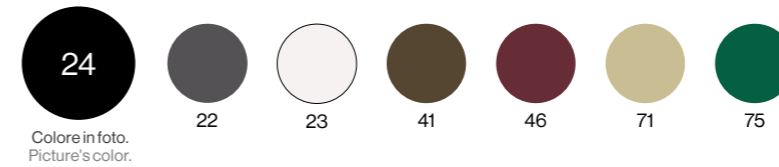

CUSCINI—CUSHIONS

Codice/Code Tipologia/Typology	Colori tessuto Fabric colors	Categoria tessuto Fabric category
C/1204 Cuscino seduta—Seat cushion x cod. 1204 W73 - D66 - H9 Kg 1,5		Vedi pg. 58 Look at pg. 58
C/1205 Cuscino seduta—Seat cushion x cod. 1205 W148 - D67 - H9 Kg 3,1		
C/1206 Cuscino schienale—Back cushion x cod. 1204, 1205 W58 - D40 - H18 Kg 1,0		
C/701 Cuscino decorativo—Decorative cushion x cod. 1204, 1205 W40 - D40 - H15 Kg 0,7		Vedi pg. 369 Look at pg. 369
C/705 Cuscino decorativo—Decorative cushion x cod. 1204, 1205 W45 - D35 - H15 Kg 0,7		
C/706 Cuscino decorativo—Decorative cushion x cod. 1204, 1205 W60 - D40 - H20 Kg 0,9		

Tessuti Basic (Vedi riepilogo pg. 58)
Tessuti Standard (Vedi riepilogo pg. 58)*
Tessuti Exclusive (Vedi riepilogo pg. 58)
Basic Fabrics (Look at pg. 58)
Standard Fabrics (Look at pg. 58)*
Exclusive Fabrics (Look at pg. 58)

Tessuti Basic (Vedi riepilogo pg. 369)
Tessuti Standard (Vedi riepilogo pg. 369)
Tessuti Exclusive (Vedi riepilogo pg. 369)
Basic Fabrics (Look at pg. 369)
Standard Fabrics (Look at pg. 369)
Exclusive Fabrics (Look at pg. 369)



TESSUTI CUSCINI—CUSHION FABRICS C/1200 - C/1201 - C/1204 - C/1205 - C/1206

Composizione/Categoria tessuti Composition/Fabrics category	Colori Colors
TESSUTI BASIC—BASIC FABRICS	
Acrilico—Acrylic	700/4
	700/10
	700/13
	700/32
	700/34
TESSUTI STANDARD—STANDARD FABRICS	
88% Acrilico, 12% Poliestere—88% Acrylic, 12% Polyester	900/02
	900/05
	900/07
	900/08
	900/09
Acrilico—Acrylic	900/18
	900/71
	900/75
	900/77
	TESSUTI EXCLUSIVE—EXCLUSIVE FABRICS
CAT. E Visitare il nostro sito web www.emu.it —Visit our website www.emu.it	600/31
	600/32
	600/33
	600/34
	600/35
	600/36
	600/37
	600/38
	600/39
	600/40
	600/41
	600/42
	600/43
	600/48
	600/49
CAT. D Visitare il nostro sito web www.emu.it —Visit our website www.emu.it	600/27
	900/16
	600/07
	600/14
	600/16
CAT. C Visitare il nostro sito web www.emu.it —Visit our website www.emu.it	600/18
	600/11
	600/11
CON TESSUTO CLIENTE—WITH CUSTOMER'S FABRIC	
FABBISOGNO TESSUTO (cm)—FABRIC REQUIRED (cm)	C/1200 132x90, C/1201 132x54, C/1204 132x190, C/1205 132x270, C/1206 132x90

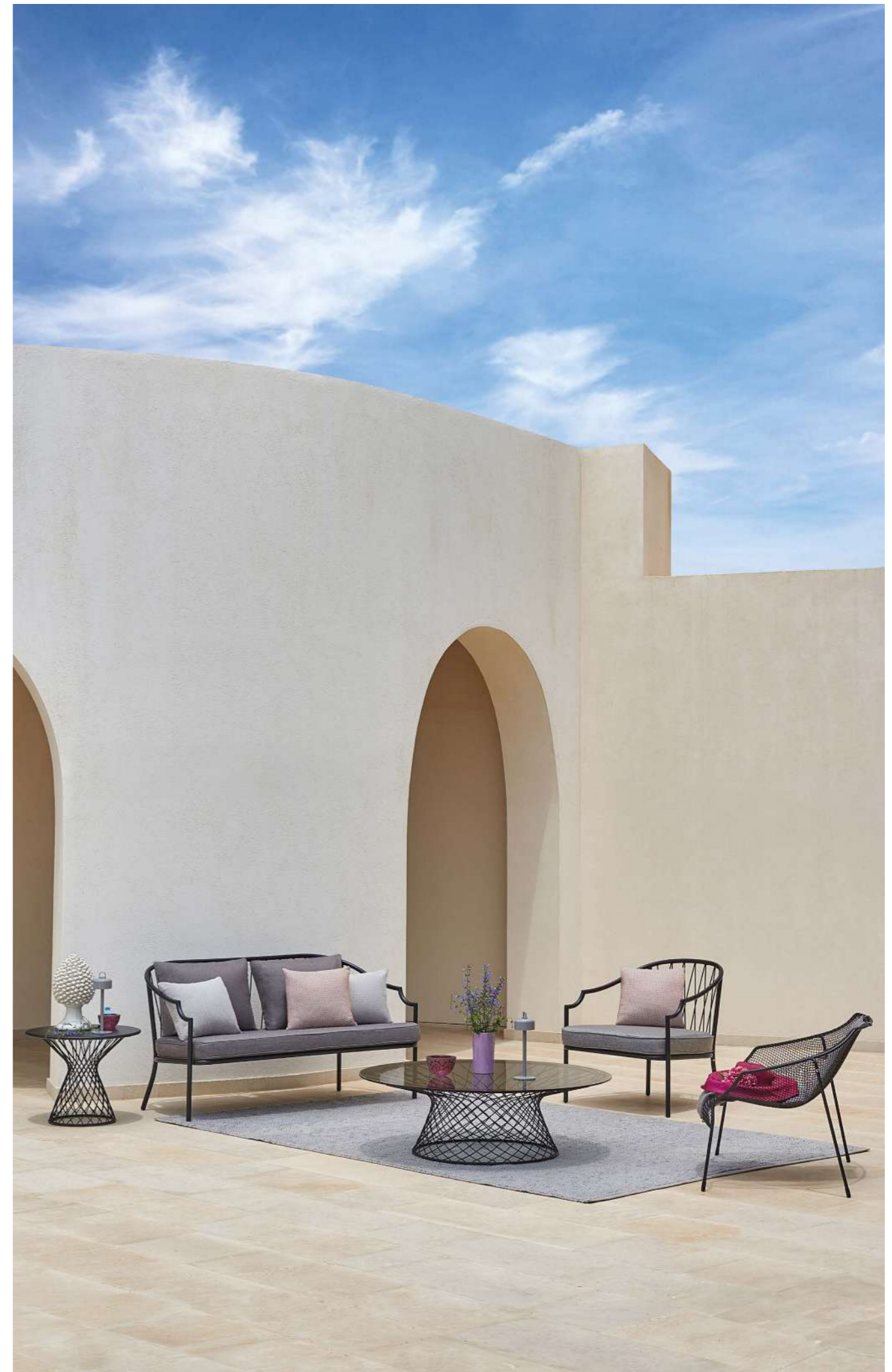

COUPOLE

Design by EMU D&S Lab



Scansiona e scopri i progetti.
Scan and discover the projects.



440
Sedia
Chair



Sedile e schienale sono caratterizzati da un motivo geometrico realizzato con asole anch'esse imbutite, che conferisce un aspetto di leggerezza alla seduta.
Seat and back are featured by a geometric pattern with moulded holes that gives lighthness to the chair.

442
Sgabello
Stool



Le forme tondeggianti a cupola del tubolare di struttura permettono l'arrotondamento dello schienale garantendo un miglior comfort.
The dome-shaped structure of the tubular frame makes the backrest embracing and comfortable.

COMBINAZIONI CONSIGLIATE—SUGGESTED MATCHINGS

60



PLUS4
Cod. 3484
Tavolo allungabile
Balcony 4/6+2 posti
4/6+2 seats Balcony
extensible table
PAG. 166



NOVA
Cod. 858
Tavoloquadrato
impilabile 2 posti
2 seats stackable
square table
PAG. 160



ROUND
Cod. 475
Tavolo alto 2 posti
2 seats counter table
PAG. 212

PRODOTTI—PRODUCTS

Codice/Code Tipologia/Typology	Disegno/Drawing	Info
-----------------------------------	-----------------	------

440

Sedia
Chair
W46 - D53 - H83
Kg 4,7

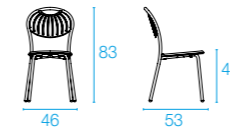

442

Sgabello
Barstool
W51 - D52 - H111
Kg 6,3

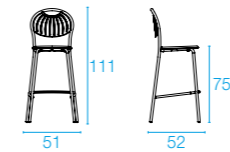

COLORI STRUTTURA—FRAME COLORS

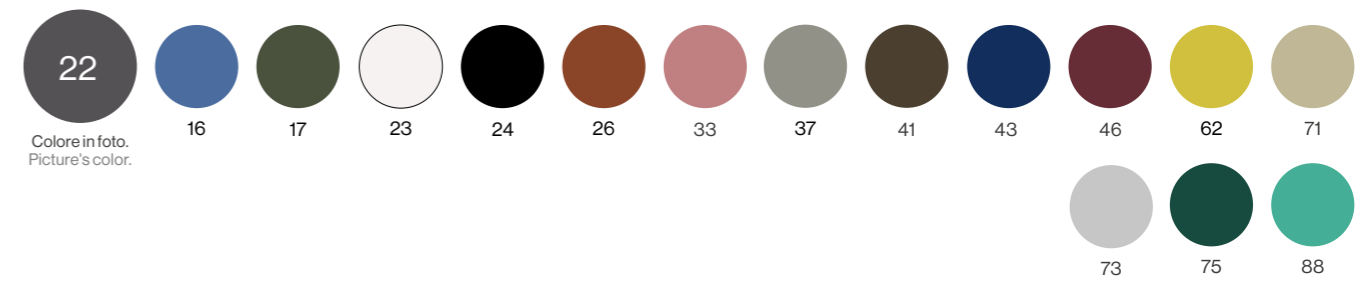

CUSCINI—CUSHIONS

Codice/Code Tipologia/Typology	Colori tessuto Fabric colors	Categoria tessuto Fabric category
C/715 Cuscino magnetico poliestere tondo Round magnetic poliester cushion x cod. 440, 442 ø37 - H2 Kg 0,15	500/32 500/33 500/34 500/35* 500/36	Tessuti Cuscini Contract Contract Cushions Fabrics
C/704 Cuscino EMU acrilico tondo Acrylic EMU round cushion x cod. 440, 442 ø38,5 - H2 Kg 0,13	700/4 700/10 700/13 700/32 700/34	Tessuti Basic Basic Fabrics

* Cuscino visibile in foto—Cushion in the picture

PLUS

- Sedile e schienale in lamiera di acciaio zincata a caldo realizzati tramite stampo.
Hot-dip zinced steel seat and back by mould.
- Saldature del sedile con tecnica MIG per un'elevata resistenza meccanica; saldatura manuale ad ottone dello schienale per dettagli più precisi e una migliore pulizia estetica.— MIG weldings for a high mechanical resistance; backrest hand brass welding for even and refined details.
- Ridotto ingombro delle gambe a terra che rende la seduta particolarmente performante in ambienti contract di piccole dimensioni.— Its minimum volume on the ground makes this collection highly performing in small contract contexts.
- Contenute dimensioni complessive del prodotto unite alla resistenza sotto stress e a una elevata impilabilità (a 8 per la sedia e a 4 per lo sgabello).— Minimum volume on the ground combined with stress resistance and stackability (up to 8 pieces for the chairs and 4 for the stool).
- Cuscino magnetico C/715 in abbinamento.— C/715 matching magnetic cushion.

61



Scansiona e scopri i progetti.
Scan and discover the projects.



521
Sedia
Chair



Cuscino C/522 con bloccaggi laterali.
C/522 cushion with side locks.

522
Poltroncina
Armchair

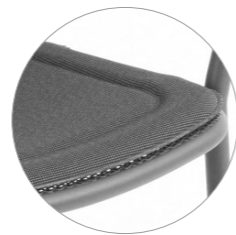

Cuscino C/707 antiscivolo in tessuto idrorepellente.
C/707 non-slip cushion in water-repellent fabric.

523
Sgabello
Barstool

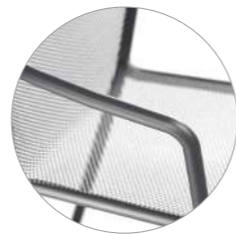

Il tubo di struttura assolve contemporaneamente la funzione portante di schienale, bracciolo e gambe anteriori.
The frame pipe simultaneously acts as load-bearing for backrest, armrest and front legs.

PRODOTTI—PRODUCTS

Codice/Code Tipologia/Typology	Disegno/Drawing	Info	TEST
521 Sedia Chair W53 - D54 - H77 Kg 5,4			EN581-1/EN581-2
522 Poltroncina Armchair W60 - D55 - H77 Kg 5,8			EN581-1/EN581-2
523 Sgabello Barstool W50 - D51 - H103 Kg 6,0			

COLORI STRUTTURA—FRAME COLORS

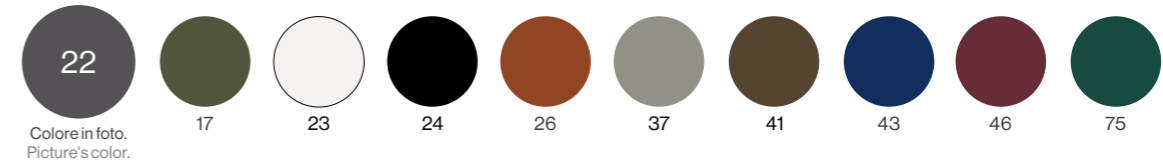

CUSCINI—CUSHIONS

Codice/Code Tipologia/Typology	Colori tessuto Fabric colors	Categoria tessuto Fabric category
C/521 Cuscino seduta acrilico—Acrylic seat cushion x cod. 521, 522 W39/43 - D38 - H2 Kg 0,19	 700/4 700/13 700/32 700/34*	Tessuti Basic Basic Fabrics
C/522 Cuscino seduta poliestere—Polyester seat cushion x cod. 521, 522 W45 - D39 - H1,5 Kg 0,27	 500/32 500/33 500/34 500/35 500/36	Tessuti Cuscini Contract Contract Cushions Fabrics
C/707 Cuscino universale poliestere Polyester universal cushion x cod. 521, 522 W45 - D39 - H1,5 Kg 0,25	 500/32 500/33 500/34 500/35* 500/36	Tessuti Cuscini Contract Contract Cushions Fabrics

* Cuscino visibile in foto—Cushion in the picture

PLUS

• Cuscino in tessuto acrilico C/521, sfoderabile, con sistema di fissaggio in velcro sotto la seduta.
C/521 acrylic fabric removable cushion cover with velcro fastening system under the seat.

DARWIN

Design by Lucidi—Pevere



Scansiona e scopri i progetti.
Scan and discover the projects.

524
Poltrona
Lounge chair



527
Divano 2 posti
2-Seater sofa

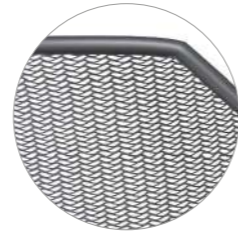

La lamiera stirata prezincata a caldo specifica per le sedute Darwin permette una elevata resistenza agli agenti atmosferici. The pre hot-zincated expanded sheet, that is specific for Darwin seat, allows a great resistance to weather conditions.

ALTRI PRODOTTI IN COLLEZIONE—OTHER COLLECTION'S PRODUCTS

64



DARWIN
Cod. 526
Tavolo basso
Coffee table
PAG. 290



DARWIN
Cod. 528
Tavolo alto
abbattibile 2 posti
2 seats collapsible
counter table
PAG. 196



DARWIN
Cod. 529
Tavolo abbattibile 2/4 posti
2/4 seats collapsible table
PAG. 196

PRODOTTI—PRODUCTS



Codice/Code Tipologia/Typology	Disegno/Drawing	Info	TEST
-----------------------------------	-----------------	------	------

524
Poltrona
Lounge chair
W77 - D73 - H75
Kg 6,7

EN581-1/ EN581-2

527
Divano 2 posti
2-Seater sofa
W140 - D73 - H75
Kg 13,3

EN581-1/ EN581-2

COLORI STRUTTURA—FRAME COLORS

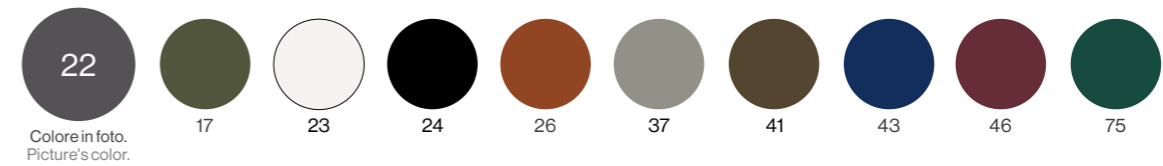

CUSCINI—CUSHIONS

Codice/Code Tipologia/Typology	Colori tessuto Fabric colors	Categoria tessuto Fabric category
C/524 Cuscino seduta acrilico Acrylic seat cushion x cod. 524 W53/58 - D49 - H2 Kg 0,32	700/4 700/13 700/32 700/34*	Tessuti Basic Basic Fabrics
C/527 Cuscino seduta acrilico Acrylic seat cushion x cod. 527 W119 - D45/50 - H2 Kg 0,82	700/4 700/13 700/32 700/34*	Tessuti Basic Basic Fabrics

* Cuscino visibile in foto—Cushion in the picture

PLUS

• Cuscini in tessuto acrilico C/524 e C/527, sfoderabile, con sistema di fissaggio in velcro sotto la seduta.
C/524 and C/527 acrylic fabric removable cushion cover with velcro fastening system under the seat.

65



Scansiona e scopri i progetti.
Scan and discover the projects.



280
Sedia
Chair



Forme esclusive che garantiscono il massimo comfort delle sedute in uso.
Specific shapes ensure maximum comfort of the seating in use.

281
Poltroncina
Armchair



La pressofusione in alluminio del sedile e dello schienale conferisce alla collezione l'esclusiva ergonomia.
The aluminium die-casting of seat and backrest makes the collection exclusively ergonomic.

283
Sgabello
Barstool



PRODOTTI—PRODUCTS

Codice/Code Tipologia/Typology	Disegno/Drawing	Info	TEST
-----------------------------------	-----------------	------	------

280 Sedia Chair W52 - D52 - H78 Kg 4,8			EN581-1 / EN581-2
--	--	--	-------------------

281 Poltroncina Armchair W52 - D58 - H78 Kg 5,2			EN581-1 / EN581-2
---	--	--	-------------------

283 Sgabello Barstool W51 - D53 - H90 Kg 5,1			
--	--	--	--

COLORI STRUTTURA—FRAME COLORS

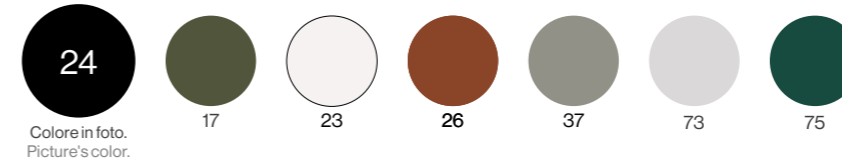

CUSCINI—CUSHIONS

Codice/Code Tipologia/Typology	Colori tessuto Fabric colors	Categoria tessuto Fabric category
C/707 Cuscino universale poliestere Polyester universal cushion x cod. 280, 281 W45 - D39 - H1,5 Kg 0,25	500/32* 500/33 500/34 500/35 500/36	Tessuti Cuscini Contract Contract Cushions Fabrics

* Cuscino visibile in foto—Cushion in the picture

ALTRI PRODOTTI IN COLLEZIONE—OTHER COLLECTION'S PRODUCTS



GRACE
Cod. 285+286
Tavolo bordo quadro abbattibile 2/4 posti
2/4 seats collapsible square edge table
PAG. 202

PLUS

- Tubo in lega di alluminio ad alta resistenza.—Pipe in high resistant aluminium alloy.
- Viteria in acciaio inossidabile che diminuisce il rischio di corrosione, ruggine e deterioramento da agenti atmosferici.
Stainless steel screws that reduce the risk of corrosion, rust and deterioration due to weather conditions.
- Cuscino universale C/707 in tessuto poliestere idrorepellente con sistema antiscivolo.
Polyester universal cushion C/707 in water-repellent fabric with non-slip system.

HEAVEN

Design by Jean-Marie Massaud



Scansiona e scopri i progetti.
Scan and discover the projects.

485
Sedia
Chair



Fissaggio cuscino con lacci.
Cushion fastening with laces.

486
Poltroncina
Armchair



La tecnologia a proiezione conferisce una migliore pulizia estetica della saldatura della rete alla struttura tubolare.
The spot technology conveys a sharper welding of the mesh to the tubular frame.

PRODOTTI—PRODUCTS



Codice/Code Tipologia/Typology	Disegno/Drawing	Info
-----------------------------------	-----------------	------

485

Sedia
Chair
W62 - D59 - H79
Kg 7,3

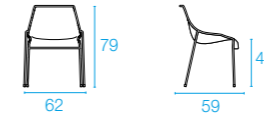

486

Poltroncina
Armchair
W69 - D61 - H79
Kg 8,5

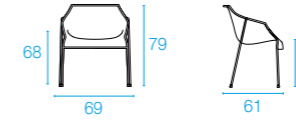

COLORI STRUTTURA—FRAME COLORS

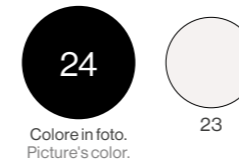

24
Colore in foto.
Picture's color.

23

CUSCINI—CUSHIONS

Codice/Code Tipologia/Typology	Colori tessuto Fabric colors	Categoria tessuto Fabric category
C/485 Cuscino seduta e schienale polipropilene Polypropylene seat and back cushion x cod. 485 W96 - D38 - H4 Kg 0,67	900/71*	Tessuti Standard Standard Fabrics
	900/75	
	900/77	
C/486 Cuscino seduta e schienale polipropilene Polypropylene seat and back cushion x cod. 486 W96 - D41 - H4 Kg 0,74	900/71*	Tessuti Standard Standard Fabrics
	900/75	
	900/77	

* Cuscino visibile in foto—Cushion in the picture

HEAVEN

Design by Jean-Marie Massaud



Scansiona e scopri i progetti.
Scan and discover the projects.

487
Poltrona
Lounge chair



495+495/S
Pouf



Il cuscino 495/S imbottito garantisce il comfort della seduta.
Cod.495/S upholstered seat cushion that ensures comfort.

ALTRI PRODOTTI IN COLLEZIONE—OTHER COLLECTION'S PRODUCTS

70



HEAVEN
Cod. 494+494/V
Tavolo tondo 4/6 posti
4/6 seats round table
PAG. 204



HEAVEN
Cod. 496+494/V
Tavolo basso
Coffee table
PAG. 292



HEAVEN
Cod. 497
Vaso alto
Tall vase
PAG. 350

PRODOTTI—PRODUCTS



Codice/Code Tipologia/Typology	Disegno/Drawing	Info
-----------------------------------	-----------------	------

487

Poltrona
Lounge chair
W94 - D78 - H69
Kg 11,3

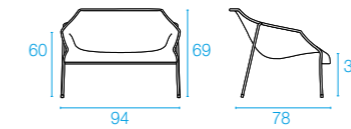

495

Struttura pouf
Pouf frame
W45 - D45 - H46
Kg 3,6



COLORI STRUTTURA—FRAME COLORS

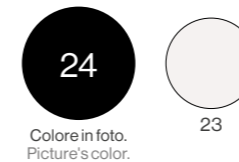

Colore in foto.
Picture's color.

CUSCINI—CUSHIONS

Codice/Code Tipologia/Typology	Colori tessuto Fabric colors	Categoria tessuto Fabric category			
C/701 Cuscino decorativo—Decorative cushion x cod. 487 W40 - D40 - H15 Kg 0,7		Vedi pg. 404 Look at pg. 404			
C/705 Cuscino decorativo—Decorative cushion x cod. 487 W45 - D35 - H15 Kg 0,7					
C/706 Cuscino decorativo—Decorative cushion x cod. 487 W60 - D40 - H20 Kg 0,9					
495/S Cuscino seduta imbottito polipropilene Polypropylene padded seat cushion x cod. 495 ø45 - H1 Kg 1,8		<table border="1"> <tr> <td>900/71*</td> </tr> <tr> <td>900/75</td> </tr> <tr> <td>900/77</td> </tr> </table> Tessuti Standard Standard Fabrics	900/71*	900/75	900/77
900/71*					
900/75					
900/77					

* Cuscino visibile in foto—Cushion in the picture

PLUS

- Lamiera intrecciata zincata a caldo, esclusiva per la collezione Heaven.
Hot-dip znced woven wire mesh, specific for Heaven collection.
- La concavità nella seduta creata da un apposito stampo rappresenta la sua forma distintiva di tutta la collezione ed è la caratteristica strutturale che ne definisce il confort.—The seat concavity shaped by an exclusive mould represents the distinctive attribute of the entire collection and is the structural feature defining comfort.
- C/485 cuscino in tessuto sfoderabile.—C/485 fabric removable cushion cover.
- Cuscino 495/S in tessuto polipropilene che può essere applicato come optional sulla struttura base in tondino di acciaio.—495/S polypropylene cushion could be assembled on the steel bar frame base as an optional.

71

HOLLY

Design by EMU D&S Lab



Scansiona e scopri i progetti.
Scan and discover the projects.



1310
Poltroncina
Armchair



Prodotti realizzati con robusti estrusi di alluminio (tubo 40x20 poltroncina, tubo 50x25 poltrona reclinabile e poggiatesta) che garantiscono una grande solidità. The aluminium extruded pipes (40x20 pipe for the armchair, 50x25 pipe for the reclining lounge chair and footrest) guarantee great solidity.

1311
Poltrona reclinabile
Reclining lounge chair



Poltrona lounge con schienale alto reclinabile in 4 posizioni. Lounge armchair with high backrest reclining in 4 positions.

1313
Poggiatesta
Footstool



PRODOTTI—PRODUCTS

Codice/Code Tipologia/Typology	Disegno/Drawing	Info
-----------------------------------	-----------------	------

1310
Poltroncina
Armchair
W57 - D60 - H86
Kg 5,6

1311
Poltrona reclinabile
Reclining lounge chair
W65 - D77 - H107
Kg 7,9

1313
Poggiatesta
Footstool
W65 - D52 - H44
Kg 6,4

COLORI STRUTTURA/TELO—FRAME/CLOTH COLORS

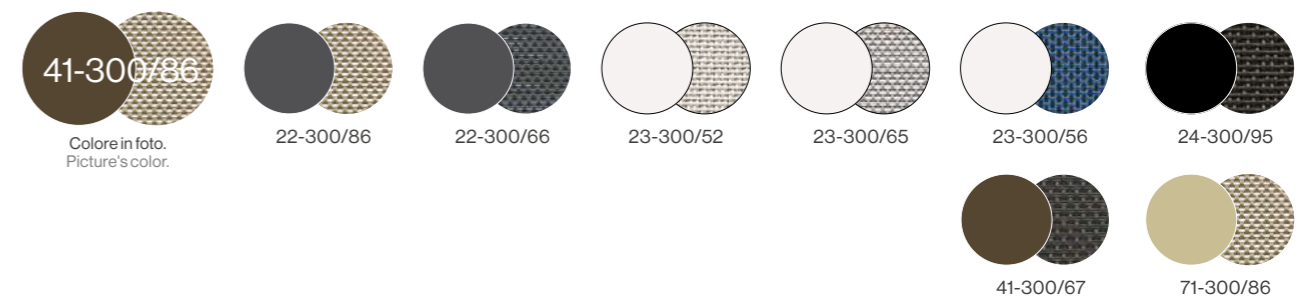

Le immagini dei colori sono a scopo illustrativo. Per vedere la trama degli EMU-Tex, consultare pg. 379.
All colors images shown are for illustration purposes only. Look at pg. 379 to see the texture of the EMU-Tex.

ALTRI PRODOTTI IN COLLEZIONE—OTHER COLLECTION'S PRODUCTS



HOLLY
Cod. 195
Letto impilabile con ruote a scomparsa
Stackable sunbed with hidden wheels
PAG. 314



HOLLY
Cod. 196
Tavolo basso
Coffee table
PAG. 294

PLUS

- Collezione completa di elementi dining e relax, ottima per tutti gli usi all'esterno e particolarmente indicata in prossimità di mare e piscine.— Complete collection made up of dining and relaxing elements, excellent for all outdoor uses and particularly suitable for swimming pools and seaside areas.
- Combinazione di alluminio ed EMU-Tex per la struttura portante. Particolari in acciaio inossidabile. Combination of aluminium and EMU-Tex for the load-bearing frame. Details in stainless steel.
- Elevata impilabilità di poltroncina e poltrona lounge reclinabile. High stackability of armchair and reclining lounge chair.
- Poggiatesta utilizzabile anche come seduta.— Footstool can also be used as seat.
- Studiata per permettere una facile sostituzione del telo da parte del cliente. Designed for an easy replacement of the cloth by the customer.



Scansiona e scopri i progetti.
Scan and discover the projects.



615
Sedia
Chair



La pressofusione in alluminio del sedile conferisce alla collezione l'esclusiva ergonomia.
The aluminium die-casting of the seat makes the collection exclusively ergonomic.

616
Poltroncina
Armchair



Cuscino sedile con antiscivolo e cuscino schienale con sistema di fissaggio in velcro.
Non-slip seat cushion and backrest cushion with velcro fastening system.

617
Poltrona
Lounge chair



L'assemblaggio dei tondini, che costituiscono la griglia dello schienale, è un processo interamente manuale che conferisce un design esclusivo al prodotto. Il fissaggio alla struttura è realizzato senza viti a vista.
The backrest grid consists of bars that are skillfully hand-assembled, creating an exclusive product design. The fixing of the backrest to the frame is made without visible screws.

PRODOTTI—PRODUCTS

Codice/Code Tipologia/Typology	Disegno/Drawing	Info	TEST
615 Sedia Chair W47 - D54 - H79 Kg 4,8			EN581-1 / EN581-2
616 Poltroncina Armchair W62 - D57 - H79 Kg 7,0			EN581-1 / EN581-2
617 Poltrona Lounge chair W76 - D72 - H73 Kg 8,3			EN581-1 / EN581-2

COLORI STRUTTURA/SEDUTA/SCHIENALE—FRAME/SEAT/BACK COLORS

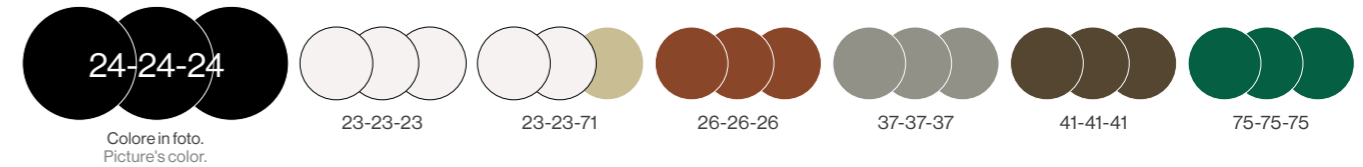

CUSCINI—CUSHIONS

Codice/Code Tipologia/Typology	Colori tessuto Fabric colors	Categoria tessuto Fabric category
C/615 Cuscino seduta acrilico Acrylic seat cushion x cod. 615, 616 W33/38 - D43 - H3 Kg 0,28	900/71* 900/75 900/77	Tessuti Standard Standard Fabrics
C/616 Cuscino seduta e schienale acrilico Acrylic seat and back cushion x cod. 616 W33/38 - D43 - H3 W41/47 - D30 - H3 Kg 0,52	900/71* 900/75 900/77	
C/617 Cuscino seduta e schienale acrilico Acrylic seat and back cushion x cod. 617 W44/49 - D50 - H3 W50/57 - D30 - H3 Kg 0,79	900/71* 900/75 900/77	

* Cuscino visibile in foto—Cushion in the picture

PLUS

- Schienale in griglia di tondini zincati a caldo saldati a proiezione.
Backrest grid made of spot welded hot-dip zincated bars.
- C/615 cuscino seduta con strato antiscivolo inferiore.— C/615 seat cushion with a non-slip layer below.



Scansiona e scopri i progetti.
Scan and discover the projects.



PRODOTTI—PRODUCTS

615
Sedia
Chair



615

Sedia
Chair
W47 - D54 - H79
Kg 5,0

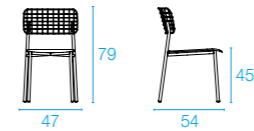

EN581-1 / EN581-2



616
Poltroncina
Armchair



616

Poltroncina
Armchair
W62 - D57 - H79
Kg 7,4

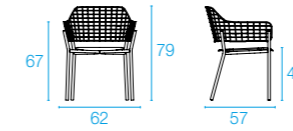

EN581-1 / EN581-2



617
Poltrona
Lounge chair



617

Poltrona
Lounge chair
W76 - D72 - H73
Kg 8,6

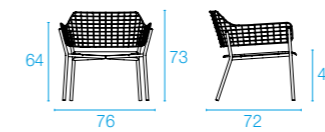

EN581-1 / EN581-2



COLORI STRUTTURA/SEDUTA/SCHIENALE—FRAME/SEAT/BACK COLORS

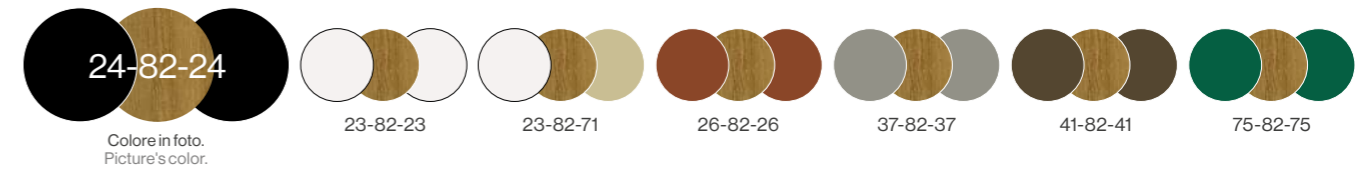

Sedile in teak FSC® per un piacevole effetto tattile e visivo.
Teak FSC® seat for a pleasant touch, look and feel.

COMBINAZIONI CONSIGLIATE—SUGGESTED MATCHINGS



TWINS
Cod. 6061
Tavolo quadrato 4 posti
4 seats square table
PAG. 182



SHINE
Cod. 252
Tavolo basso
Coffee table
PAG. 300



SHINE
Cod. 296
Tavolo allungabile 8+2/4 posti
8+2/4 seats extensible table
PAG. 174

PLUS

- Al caratteristico disegno del prodotto si aggiunge la nota naturale e sofisticata del teak che ne permette un utilizzo più trasversale anche in ambienti indoor.—The natural and sophisticated teak nuance enhances the characteristic design of the product and make the collection even suitable to indoor contexts.
- Il sedile in teak si dimostra particolarmente performante in ambienti dai climi caldi dove si predilige tale tipo di materiale a contatto in suo con l'utilizzatore.—Teak version mostly fits to hot weather locations that request no metal part touching the user and is very suitable.
- Il comfort delle sedute è garantito anche senza l'utilizzo del cuscino.
The seating comfort is ensured even without cushion.



Scansiona e scopri i progetti.
Scan and discover the projects.



410
Sedia
Chair



Sedile e schienale in lamiera imbutita di alluminio che conferiscono alle sedute l'esclusiva ergonomia.
Deep-drawn aluminium seat and backrest make the seating exclusively ergonomic.

411
Poltroncina
Armchair



412
Sgabello
Barstool



Protezione poggia piedi in acciaio inossidabile AISI 316 che diminuisce il rischio di corrosione e deterioramento.
AISI 316 stainless steel footrest component that reduces the risk of corrosion and deterioration.

PRODOTTI—PRODUCTS

Codice/Code Tipologia/Typology	Disegno/Drawing	Info	TEST
410 Sedia Chair W49 - D52 - H78 Kg 5,5			EN581-1 / EN581-2
411 Poltroncina Armchair W57 - D52 - H78 Kg 5,6			EN581-1 / EN581-2
412 Sgabello Barstool W47 - D50 - H99 Kg 7,7			

COLORI STRUTTURA—FRAME COLORS

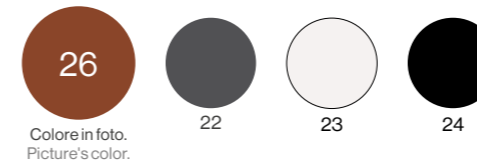

CUSCINI—CUSHIONS

Codice/Code Tipologia/Typology	Colori tessuto Fabric colors	Categoria tessuto Fabric category
C/703 Cuscino EMU acrilico quadrato Acrylic EMU square cushion x cod. 410, 411, 412 W38 - D38 - H2 Kg 0,17		Tessuti Basic Basic Fabrics
C/709 Cuscino universale poliestere Polyester universal cushion x cod. 410, 411, 412 W37,5 - D37,5 - H1,5 Kg 0,2		Tessuti Cuscini Contract Contract Cushions Fabrics
C/716 Cuscino universale poliestere Polyester universal cushion x cod. 410, 411, 412 W38 - D40 - H1,5 Kg 0,24		Tessuti Cuscini Contract Contract Cushions Fabrics

* Cuscino visibile in foto—Cushion in the picture

COMBINAZIONI CONSIGLIATE—SUGGESTED MATCHINGS



DARWIN
Cod. 529
Tavolo abbattibile 2/4 posti
2/4 seats collapsible table
PAG. 196



ROUND
Cod. 472
Tavolo quadrato 2 posti
2 seats square table
PAG. 210



NOVA
Cod. 893
Tavolo alto rettangolare
4 posti
4 seats counter
rectangular table
PAG. 162

PLUS

- Struttura in tubo acciaio ad alta resistenza.—High-strength steel pipe frame.
- Cuscino in tessuto acrilico C/703, sfoderabile, con fissaggio tramite laccetti.
C/703 acrylic fabric removable cushion cover with laces fastening.
- Cuscino C/709 e C/716 con fissaggio antiscivolo.—Non-slip cushions C/709 and C/716.



Scansiona e scopri i progetti.
Scan and discover the projects.



639
Sedia
Chair

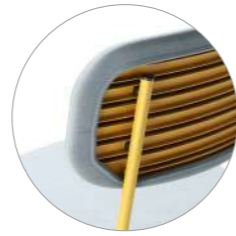

Cuscini in tessuto acrilico C/640 e C/641 con fissaggio tramite elastico.
C/640 and C/641 acrylic cushions with rubber band fastening.

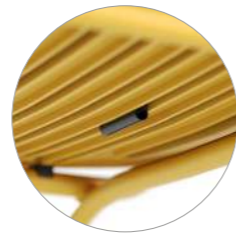

Cuscino in poliestere C/639 con fissaggio tramite clip a incastro.
C/639 polyester cushion with snap-fit clip fastening to the seat grooves.



Fissaggio dello schienale alla struttura tramite rivetti in acciaio inox che riducono il rischio di corrosione, ruggine e deterioramento.
The backrest is fixed to the frame with stainless steel rivets that reduce risk of corrosion, rust and deterioration.

640
Poltroncina
Armchair



PRODOTTI—PRODUCTS

Codice/Code Tipologia/Typology	Disegno/Drawing	Info	TEST
-----------------------------------	-----------------	------	------

639

Sedia
Chair
W53 - D56 - H76
Kg 6,9

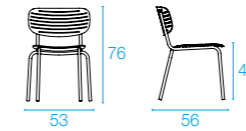

EN581-1/ EN581-2

640

Poltroncina
Armchair
W58,5 - D56 - H76
Kg 8,0

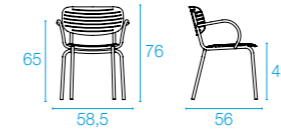

EN581-1/ EN581-2

COLORI STRUTTURA—FRAME COLORS

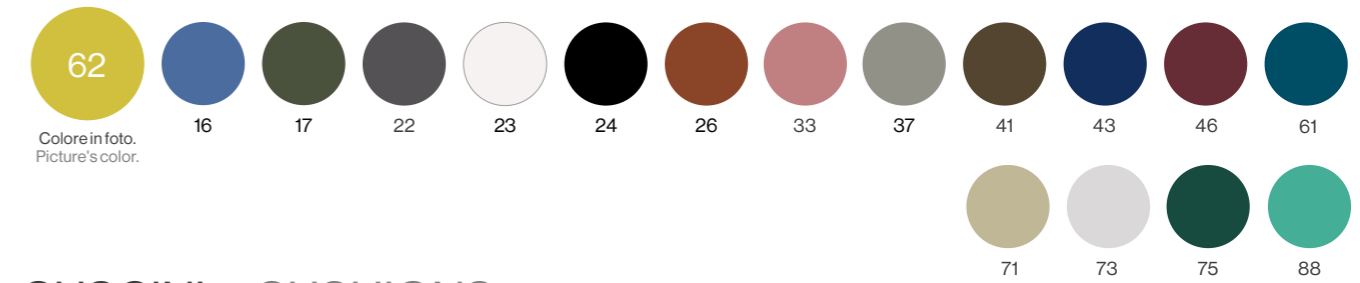

CUSCINI—CUSHIONS

Codice/Code Tipologia/Typology	Colori tessuto Fabric colors	Categoria tessuto Fabric category
C/639 Cuscino seduta poliestere Polyester seat cushion x cod. 639, 640 W35/43 - D43 - H1,5 Kg 0,28	500/32* 500/33 500/34 500/35 500/36	Tessuti Cuscini Contract Contract Cushions Fabrics
C/640 Cuscino seduta acrilico Acrylic seat cushion x cod. 639, 640 W38/45 - D45 - H2,5 Kg 0,22	700/4 700/10* 700/13 700/32 700/34	Tessuti Basic Basic Fabrics
C/641 Cuscino schienale acrilico Acrylic back cushion x cod. 639, 640 W53 - D26 - H3 Kg 0,17	700/4 700/10* 700/13 700/32 700/34	Tessuti Basic Basic Fabrics
C/708 Cuscino universale poliestere Polyester universal cushion x cod. 639, 640 W45 - D43 - H1,5 Kg 0,22	500/32 500/33 500/34 500/35 500/36	Tessuti Cuscini Contract Contract Cushions Fabrics

* Cuscino visibile in foto—Cushion in the picture

COMBINAZIONI CONSIGLIATE—SUGGESTED MATCHINGS



TABLE SYSTEM
Cod. 1156
Tavolo bordo tondo
5/6 posti
5/6 seats round
edge table
PAG. 216



PLUS4
Cod. 3485
Tavolo allungabile
6+4 posti
6+4 seats
extensible table
PAG. 166



NOVA
Cod. 859
Tavolo quadrato
impilabile 4 posti
4 seats stackable
square table
PAG. 160

PLUS

• Fessure di lamiera conformi a direttive di sicurezza internazionali.

Sheet grooves compliant with international safety regulations.

• Sedile e schienale in lamiera stampata prezinata a caldo, particolarmente resistente agli agenti atmosferici, sagomati per migliorare il comfort della seduta.—Moulded seat and backrest in pre hot-zincated sheet shaped to improve the comfort of the seat. Extreme resistance to weather conditions.



Scansiona e scopri i progetti.
Scan and discover the projects.



626
Poltroncina
Armchair

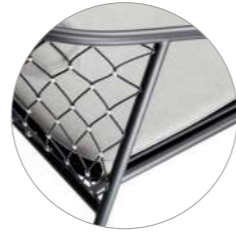

Schienale realizzato con una rete in fibra di polipropilene e ganci in acciaio inossidabile che garantisce il comfort della collezione. La rete è fissata alla struttura perimetrale tramite un sistema esclusivo sviluppato da EMU e brevettato. Backrest made of a polypropylene fiber net and stainless steel hooks that guarantees maximum comfort to the seating collection. The net is fixed to the perimeter frame with an exclusive system developed and patented by EMU.

627
Poltrona schienale alto
Lounge chair tall back



Cuscino schienale con sistema di fissaggio tramite elastici e gancetti. Cuscino seduta con sistema di fissaggio in velcro. Backrest cushion with fastening system by rubber bands and hooks. Seat cushion with velcro fastening system.

628
Poltrona schienale basso
Lounge chair short back



PRODOTTI—PRODUCTS

Codice/Code Tipologia/Typology	Disegno/Drawing	Info	TEST
-----------------------------------	-----------------	------	------

626 Poltroncina Armchair W63 - D60 - H81 Kg 4,1			EN581-1 / EN581-2
--	--	--	-------------------

627 Poltrona schienale alto Lounge chair tall back W88 - D84 - H125 Kg 8,8			EN581-1 / EN581-2
---	--	--	-------------------

628 Poltrona schienale basso Lounge chair short back W83 - D76 - H83 Kg 7,4			
--	--	--	--

COLORI STRUTTURA/SCHIENALE—FRAME/BACK COLORS

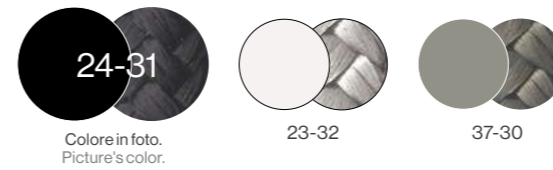

CUSCINI—CUSHIONS

Codice/Code Tipologia/Typology	Colori tessuto Fabric colors	Categoria tessuto Fabric category
C/626 Cuscino seduta acrilico Acrylic seat cushion x cod. 626 W40/45 - D43 - H4 Kg 0,45	900/71* 900/75 900/77	Tessuti Standard Standard Fabrics
S/626 Cuscino schienale acrilico Acrylic back cushion x cod. 626 W51 - D19 - H2,5 Kg 0,17	900/71* 900/75 900/77	
C/627 Cuscino seduta e schienale acrilico Acrylic seat and back cushion x cod. 627, 628 W40/63 - D58 - H10 W40/63 - D50 - H10 Kg 2,02	900/71* 900/75 900/77	

* Cuscino visibile in foto—Cushion in the picture

COMBINAZIONI CONSIGLIATE—SUGGESTED MATCHINGS



YARD
Cod. 509
Tavolo basso
Coffee table
PAG. 306



TERRAMARE
Cod. 725
Tavolo rettangolare 8 posti
con piano in gres
8 seats rectangular table
with gres top
PAG. 178



URBAN
Cod. 096
Tavolo impilabile 2/4 posti
2/4 seats stackable table
PAG. 184

PLUS

• Leggerezza garantita da una robusta struttura in tubolare di alluminio a cui è fissato un sedile in lamiera di alluminio piegato e sagomato.—Lightness guaranteed by a sturdy aluminium tubular frame to which a folded and shaped aluminium sheet seat is attached.
• C/627 cuscino sfoderabile. Imbottitura interna in poliuretano e poliestere espanso.—C/627 removable cushion cover. Expanded polyurethane and polyester inner padding.



Scansiona e scopri i progetti.
Scan and discover the projects.



909
Sedia
Chair



910
Poltroncina
Armchair



Sedile in lamiera stirata zincata a caldo con saldature di precisione su tubolare di struttura.
Seat made of hot-dip zincated expanded sheet finely welded to the tubular frame.

924
Sedia pieghevole
Folding chair



Sedile in lamiera di acciaio zincata a caldo con fori decorativi che facilitano il deflusso dell'acqua.
Seat made of hot-dip zincated steel sheet with decorative holes that facilitate the water drainage.

PRODOTTI—PRODUCTS

Codice/Code Tipologia/Typology	Disegno/Drawing	Info
909 Sedia Chair W45 - D52 - H85 Kg 5,2		
910 Poltroncina Armchair W50 - D54 - H85 Kg 6,8		
924 Sedia pieghevole Folding chair W42 - D57 - H88 Kg 5,6		

COLORI STRUTTURA—FRAME COLORS

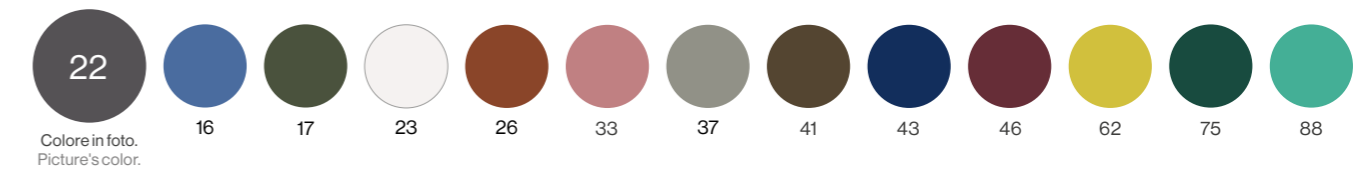

CUSCINI—CUSHIONS

Codice/Code Tipologia/Typology	Colori tessuto Fabric colors	Categoria tessuto Fabric category
C/715 Cuscino magnetico poliester tondo Polyester round magnetic cushion x cod. 909, 910, 924 ø38 - H1,5 Kg 0,17		Tessuti Cuscini Contract Contract Cushions Fabrics
C/704 Cuscino EMU acrilico tondo Acrylic EMU round cushion x cod. 909, 910, 924 ø38,5 - H2 Kg 0,13		Tessuti Basic Basic Fabrics

* Cuscino visibile in foto—Cushion in the picture

ALTRI PRODOTTI IN COLLEZIONE—OTHER COLLECTION'S PRODUCTS



PIGALLE
Cod. 906
Tavolo tondo 2/4 posti
2/4 seats round table
PAG. 164



PIGALLE
Cod. 907
Tavolo pieghevole
2/4 posti
2/4 seats folding table
PAG. 164



PIGALLE
Cod. 903
Tavolo pieghevole 4/6 posti
4/6 seats folding table
PAG. 165

PLUS

• Cuscino magnetico C/715 in abbinamento. Cuscino sfoderabile C/704.
C/715 matching magnetic cushion. C/704 removable cushion cover.
• Cod. 924: ottima per il rimessaggio invernale, piegata occupa pochissimo spazio.
Cod. 924: perfect for winter storage, it can be folded taking a very little space.

RE-TROUVÉ

Design by Patricia Urquiola



Scansiona e scopri i progetti.
Scan and discover the projects.



565
Sedia
Chair



Lo stile romantico e iconico della collezione Re-Trouvé evoca forme tipiche della lavorazione artigianale.
The romantic and iconic style of the Re-Trouvé collection recalls handcrafted shapes.

566
Poltroncina
Armchair



Fissaggio cuscino schienale con lacci.
Back cushion fastening with laces.

575
Pouf



La struttura realizzata in tondini di acciaio zincato piegati con macchine a controllo numerico, per una maggiore precisione ed un migliore controllo del processo produttivo.
The frame is manufactured in hot-dip zincated steel bar bent with numerical control machines for a more precise and accurate manufacturing process.

PRODOTTI—PRODUCTS

Codice/Code Tipologia/Typology	Disegno/Drawing	Info
565 Sedia Chair W66 - D60 - H78 Kg 7,3		
566 Poltroncina Armchair W76 - D61 - H105 Kg 8,8		
575 Pouf ø45 - H45 Kg 5,0		

COLORI STRUTTURA—FRAME COLOR

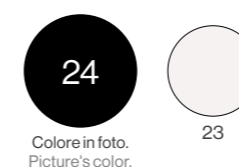

CUSCINI—CUSHIONS

Codice/Code Tipologia/Typology	Colori tessuto Fabric colors	Categoria tessuto Fabric category
C/566 Cuscino seduta e schienale acrilico Acrylic seat and back cushion x cod. 565, 566 ø47 - H6 W60/73 - D25 - H4 Kg 0,97	900/71 900/75*	Tessuti Standard Standard Fabrics
C/575 Cuscino seduta acrilico Acrylic seat cushion x cod. 565, 566, 575 ø47 - H6 Kg 0,47	900/71 900/75*	Tessuti Standard Standard Fabrics

* Cuscino visibile in foto—Cushion in the picture

PLUS

- Sedile in lamiera stirata pre zincata a caldo saldato al tondino di struttura. Tale unico pezzo viene successivamente cataforizzato per aumentare la resistenza all'ossidazione anche nei punti più critici.
The seat made of pre hot-dip zincated expanded sheet is welded to the bar frame. This single piece is then cathaphorised to increase the resistance to oxidation even on the most critical points.
- Sottopiedi in nylon trasparente per maggiore stabilità su suolo irregolare, elementi comuni a sedute, tavoli e vasi.
The transparent nylon feet for a better stability on irregular floor are common elements for seats, tables and vases.
- Cuscino sedile con sistema di fissaggio in velcro.—Seat cushion with velcro fastening system.
- Cuscini sfoderabili e lavabili.—Removable cover and washable cushions.

ALTRI PRODOTTI IN COLLEZIONE—OTHER COLLECTION'S PRODUCTS



RE-TROUVÉ
Cod. 569B+569P
Tavolo tondo 5 posti
5 seats round table
PAG. 208



RE-TROUVÉ
Cod. 570B+570P
Tavolo tondo 6 posti
6 seats round table
PAG. 208



RE-TROUVÉ
Cod. 577+580
Vaso alto
Tall vase
PAG. 358

RIO R50

Design by Cristell—Gargano



Scansiona e scopri i progetti.
Scan and discover the projects.



790
Sedia
Chair



Rete in tondino zincato a caldo per una maggiore resistenza agli agenti atmosferici. I tondini, saldati a proiezione, garantiscono una maggiore precisione e resistenza strutturale.

Hot-dip zincated bar mesh for a greater weathering resistance. The bars are spot welded for a higher precision and structural strength.

791
Poltroncina
Armchair

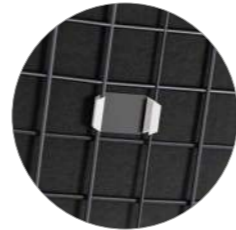

Sistema di aggancio tramite clip.
Fastening system with clip.

793
Sgabello
Barstool



Sagomatura ergonomica conferita da uno specifico stampo di imbottitura.
Ergonomic shape due to the use of a specific cupping mould.

PRODOTTI—PRODUCTS

Codice/Code Tipologia/Typology	Disegno/Drawing	Info	TEST
-----------------------------------	-----------------	------	------

790 Sedia Chair W53,5 - D61,5 - H83,5 Kg 5,6			EN581-1/EN581-2
--	--	--	-----------------

791 Poltroncina Armchair W53,5 - D59 - H83,5 Kg 6,2			EN581-1/EN581-2
---	--	--	-----------------

793 Sgabello Barstool W49 - D55 - H96 Kg 7,3			EN581-1/EN581-2
--	--	--	-----------------

COLORI STRUTTURA—FRAME COLORS

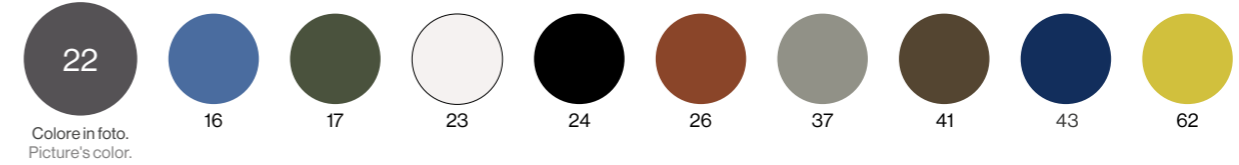

CUSCINI—CUSHIONS

Codice/Code Tipologia/Typology	Colori tessuto Fabric colors	Categoria tessuto Fabric category
C/790** Cuscino poliestere Polyester cushion x cod. 790, 791 W41 - D36 - H2 Kg 0,23	 500/32* 500/33 500/34 500/35 500/36	Tessuti Cuscini Contract Contract Cushions Fabrics
C/793 Cuscino seduta poliestere Polyester seat cushion x cod. 793 W33 - D31 - H2 Kg 0,16	 500/32* 500/33 500/34 500/35 500/36	Tessuti Cuscini Contract Contract Cushions Fabrics

* Cuscino visibile in foto—Cushion in the picture

** Cuscino utilizzabile sia per la seduta sia per lo schienale—Cushion fit for both seat and backrest use

RIO R50

Design by Cristell—Gargano



Scansiona e scopri i progetti.
Scan and discover the projects.

792
Poltrona
Lounge chair



Effetto a rilievo dell'imbottitura che segue le linee della rete in tondini per coniugare il comfort con la ricercatezza estetica. Embossed quilted effect of the padding consistent to the bars grid that balances comfort and aesthetic refinement.

795
Poltrona dondolo
Rocking lounge chair



Poltrona a dondolo con protezione gamba a slitta in PVC. The rocking chair has a PVC sled leg protection.

ALTRI PRODOTTI IN COLLEZIONE—OTHER COLLECTION'S PRODUCTS

90



RIO R50
Cod. 797
Tavolo basso
Coffee table
PAG. 296

PRODOTTI—PRODUCTS



Codice/Code Tipologia/Typology	Disegno/Drawing	Info	TEST
-----------------------------------	-----------------	------	------

792
Poltrona
Lounge chair
W69 - D70 - H76
Kg 7,5

EN581-1/EN581-2

795
Poltrona dondolo
Rocking lounge chair
W67 - D72 - H77
Kg 8,0

COLORI STRUTTURA—FRAME COLORS

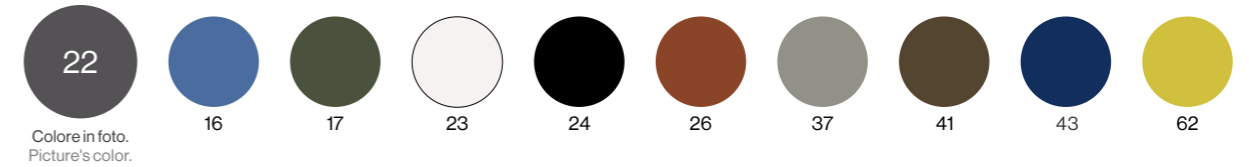

CUSCINI—CUSHIONS

Codice/Code Tipologia/Typology	Colori tessuto Fabric colors	Categoria tessuto Fabric category
C/792 Cuscino seduta poliesteri Polyester seat cushion x cod. 792, 795 W55 - D43 - H2 Kg 0,36	500/32* 500/33 500/34 500/35 500/36	Tessuti Cuscini Contract Contract Cushions Fabrics
C/795 Cuscino schienale poliesteri Polyester back cushion x cod. 792, 795 W55 - D36 - H2 Kg 0,30	500/32* 500/33 500/34 500/35 500/36	Tessuti Cuscini Contract Contract Cushions Fabrics

* Cuscino visibile in foto—Cushion in the picture

PLUS

- Tubo in acciaio Asform ad alta resistenza meccanica.—Asform steel pipe with high static load resistance.
- Cuscini magnetici universali a calamita.—Universal magnetic cushions.
- Cuscino seduta C/792 e schienale c/795 in poliesteri che simulano l'effetto della rete di tondino ed impreziosisce il design della seduta.—C/792 seat and c/795 back polyester cushions simulate the bars grid and enrich the seat design.
- Cuscino C/790 seduta utilizzabile sia per il sedile che per lo schienale. C/790 seat cushion that fits for the seat seat and also for the backrest.

91



Scansiona e scopri i progetti.
Scan and discover the projects.



434
Sedia
Chair



Piatto in acciaio con profilo a mezza mandorla utilizzato esclusivamente per la collezione Riviera.
Half almond steel profile exclusively used for Riviera collection.

435
Poltroncina
Armchair



Cuscino C/435 con fissaggio tramite clip ad incastro.
C/435 cushion with snap-fit clip fastening system.

436
Sgabello
Barstool



PRODOTTI—PRODUCTS

Codice/Code Tipologia/Typology	Disegno/Drawing	Info	TEST
434 Sedia Chair W50 - D56,5 - H78 Kg 6,6			EN581-1/EN581-2
435 Poltroncina Armchair W52 - D56,5 - H78 Kg 7,8			EN581-1/EN581-2
436 Sgabello Barstool W55 - D52,5 - H96 Kg 6,3			

COLORI STRUTTURA—FRAME COLORS

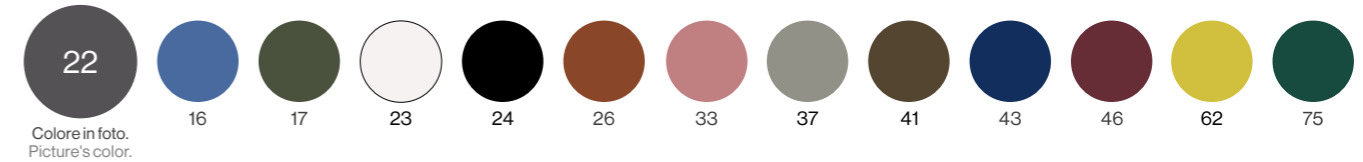

CUSCINI—CUSHIONS

Codice/Code Tipologia/Typology	Colori tessuto Fabric colors	Categoria tessuto Fabric category
C/434 Cuscino seduta Seat cushion x cod. 434, 435		900/02 900/07 900/71* 900/75 900/77 Tessuti Standard Standar Fabrics
C/435 Cuscino seduta poliestere Polyester seat cushion x cod. 434, 435 W40 - D38 - H1,5 Kg 0,25		500/32* 500/33 500/34 500/35 500/36 Tessuti Cuscini Contract Contract Cushions Fabrics
C/716 Cuscino universale poliestere Polyester universal cushion x cod. 434, 435 W38 - D40 - H1,5 Kg 0,24		500/32 500/33 500/34 500/35 500/36 Tessuti Cuscini Contract Contract Cushions Fabrics

* Cuscino visibile in foto—Cushion in the picture

PLUS

• Saldobrasature a ottone che conferiscono alle saldature un aspetto estetico molto pulito.
Brass brazing that makes the welding points even and aesthetically refined.



Scansiona e scopri i progetti.
Scan and discover the projects.

437
Poltrona
Lounge chair



Cuscino sfoderabile C/437 in tessuto con fissaggio in velcro.
C/437 fabric removable cushion cover with velcro fastening system.

PRODOTTI—PRODUCTS



Codice/Code Tipologia/Typology	Disegno/Drawing	Info	TEST
-----------------------------------	-----------------	------	------

437
Poltrona
Lounge chair
W66,5 - D72 - H69
Kg 9,2

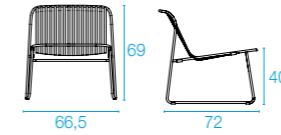

EN581-1/ EN581-2

COLORI STRUTTURA—FRAME COLORS

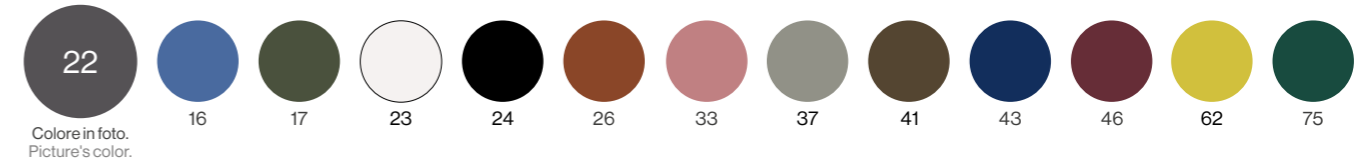

CUSCINI—CUSHIONS

Codice/Code Tipologia/Typology	Colori tessuto Fabric colors	Categoria tessuto Fabric category
C/437 Cuscino seduta Seat cushion x cod. 437	<ul style="list-style-type: none"> 900/02 900/07 900/71* 900/75 900/77 	Tessuti Standard Standar Fabrics

* Cuscino visibile in foto—Cushion in the picture

COMBINAZIONI CONSIGLIATE—SUGGESTED MATCHINGS

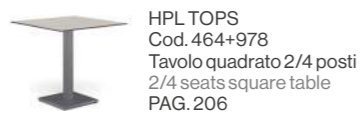

HPL TOPS
Cod. 464+978
Tavolo quadrato 2/4 posti
2/4 seats square table
PAG. 206



ROUND
Cod. 475
Tavolo alto 2 posti
2 seats counter table
PAG. 212



ROUND
Cod. 477
Tavolo basso
Coffee table
PAG. 298

RONDA

Design by Aldo Ciabatti



Scansiona e scopri i progetti.
Scan and discover the projects.



111
Sedia
Chair



116
Poltroncina
Armchair



128
Sgabello
Barstool



Fissaggio cuscino con laccetti.
Cushion fastening with laces.

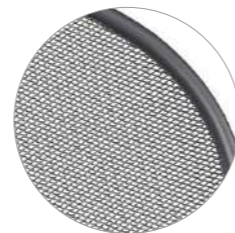

Lamiera stirata zincata a caldo.
Hot-dip znced expanded sheet.

COMBINAZIONI CONSIGLIATE—SUGGESTED MATCHINGS



CAMBI
Cod. 803
Tavolo tondo 4 posti
4 seats round table
PAG. 154



NOVA
Cod. 890
Tavolo alto
quadrato 2 posti
2 seats counter
square table
PAG. 162



CAMBI
Cod. 810
Tavolo rettangolare 8 posti
8 seats rectangular table
PAG. 158

PRODOTTI—PRODUCTS

Codice/Code Tipologia/Typology	Disegno/Drawing	Info	TEST
-----------------------------------	-----------------	------	------

111

Sedia
Chair
W59 - D63 - H85
Kg 5,2

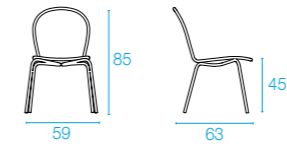

116

Poltroncina
Armchair
W60 - D65 - H82
Kg 5,1

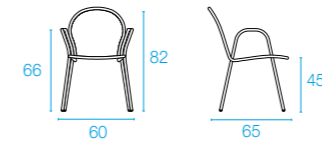

EN581-1/ EN581-2

128

Sgabello
Barstool
W54 - D65 - H117
Kg 6,5

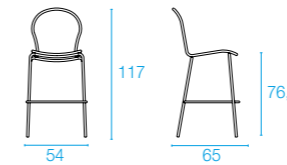

COLORI STRUTTURA—FRAME COLORS

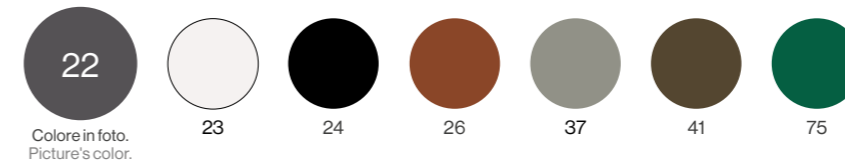

CUSCINI—CUSHIONS

Codice/Code Tipologia/Typology	Colori tessuto Fabric colors	Categoria tessuto Fabric category
C/116 Cuscino seduta e schienale acrilico Acrylic seat and back cushion x cod. 111, 116, 128 W45 - D88 - H4 Kg 0,55	700/4 700/13* 700/32 700/34	Tessuti Basic Basic Fabrics
C/116S Cuscino seduta acrilico Acrylic seat cushion x cod. 111, 116, 128 W45 - D44 - H4 Kg 0,27	700/4 700/13* 700/32 700/34	Tessuti Basic Basic Fabrics

* Cuscino visibile in foto—Cushion in the picture

PLUS

- Lamiera saldata a proiezione su tubolare di struttura.—Spot welded sheet on tubular frame.
- C/116 cuscino in tessuto acrilico fissato allo schienale tramite asola in tessuto.
C/116 acrylic fabric cushion fastened to the backrest with a fabric band.
- Rete con grandezza fori conformi a direttive di sicurezza internazionali.
Holes mesh sheet compliant with international safety regulation.

RONDA X

Design by EMU D&S Lab



457
Sedia
Chair



458
Poltroncina
Armchair



459
Sgabello
Barstool



Fissaggio cuscino con elastici e fermacorda.
Cushion fastening with rubber band and clip.

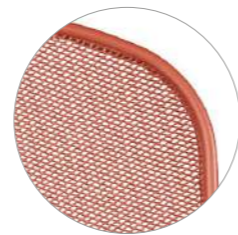

Lamiera stirata zincata a caldo utilizzata esclusivamente per la collezione Ronda X.
Hot-dip zincated expanded sheet exclusively used for Ronda X collection.

PRODOTTI—PRODUCTS

Codice/Code Tipologia/Typology	Disegno/Drawing	Info	TEST
457 Sedia Chair W51,5 - D62 - H83 Kg 4,6			EN581-1/ EN581-2
458 Poltroncina Armchair W58 - D62 - H83 Kg 5,6			EN581-1/ EN581-2
459 Sgabello Barstool W51 - D52 - H101 Kg 5,6			

COLORI STRUTTURA—FRAME COLORS

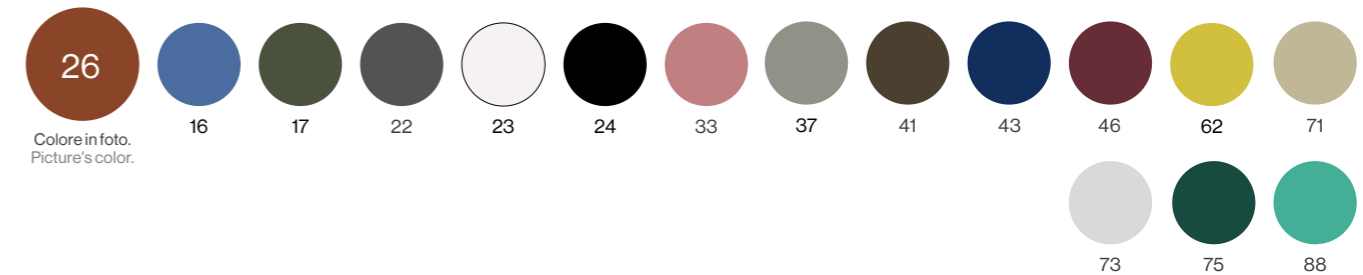

CUSCINI—CUSHIONS

Codice/Code Tipologia/Typology	Colori tessuto Fabric colors	Categoria tessuto Fabric category
C/457** Cuscino poliester Polyester cushion x cod. 457, 458 W35/42,5 - D40 - H1 Kg 0,25	 500/32 500/33 500/34 500/35* 500/36	Tessuti Cuscini Contract Contract Cushions Fabrics

* Cuscino visibile in foto—Cushion in the picture

** Cuscino utilizzabile sia per la seduta sia per lo schienale—Cushion fit for both seat and backrest use

COMBINAZIONI CONSIGLIATE—SUGGESTED MATCHINGS

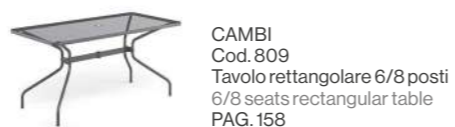
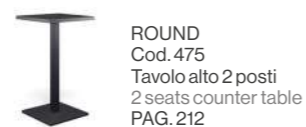
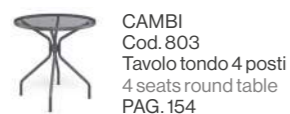

PLUS

- X come eXtra strong, eXtra simple, eXtra stylish.—X as eXtra strong, eXtra simple, eXtra stylish.
- La sagomatura longitudinale e trasversale di sedile e schienale rende la seduta estremamente confortevole. Dimensioni più generose rispetto a Ronda con un minor ingombro a terra.
The longitudinal and transversal shape of the seat and backrest makes the seating extremely comfortable. Larger sizes than Ronda allows saving space on floor.
- Tre volte più resistente agli stress meccanici di Ronda, è certificata CATAS.
Three times more resistant to mechanical stress than Ronda, it is CATAS certified.
- Realizzata in acciaio, 100% riciclabile senza alcun degrado delle proprietà meccaniche.
Made of steel, 100% recyclable without any deterioration of mechanical properties.
- Rete con grandezza fori conformi a direttive di sicurezza internazionali.
Holes mesh sheet compliant with international safety regulation.

ROUND

Design by Christophe Pillet



Scansiona e scopri i progetti.
Scan and discover the projects.

465
Sedia
Chair



466
Poltroncina
Armchair



467
Sgabello
Barstool



Lamiera stirata zincata a caldo. L'esclusiva sagomatura di sedile e schienale è realizzata tramite stampo di imbutitura che garantisce un elevato comfort in uso e caratterizza il prodotto. Hot-dip zincated expanded sheet. The exclusive moulding shape of the seat and backrest gives to the product a featuring design and high comfort in use.

PRODOTTI—PRODUCTS

Codice/Code Tipologia/Typology	Disegno/Drawing	Info	TEST
-----------------------------------	-----------------	------	------

465 Sedia Chair W63 - D58 - H79 Kg 5,7			EN581-1/ EN581-2
--	--	--	------------------

466 Poltroncina Armchair W63 - D58 - H79 Kg 6,9			
---	--	--	--

467 Sgabello Barstool W58 - D52 - H101 Kg 6,6			
---	--	--	--

COLORI STRUTTURA—FRAME COLORS

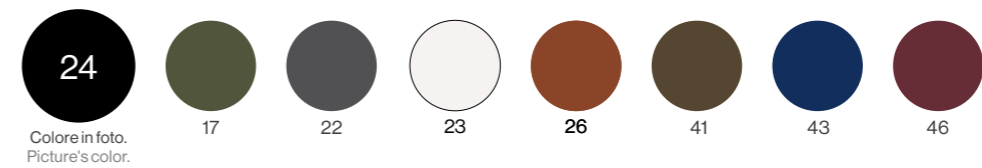

CUSCINI—CUSHIONS

Codice/Code Tipologia/Typology	Colori tessuto Fabric colors	Categoria tessuto Fabric category
C/707 Cuscino universale poliestere Polyester universal cushion x cod. 465, 466 W44 - D38 - H2 Kg 0,23		Tessuti Cuscini Contract Contract Cushions Fabrics

PLUS

- Cuscino C/707 con fissaggio antiscivolo.— Non-slip C/707 cushion.
- Saldature di precisione della rete al tubolare perimetrale di struttura.
Highly precise mesh welding to the perimeter structural pipe.
- Rete con grandezza fori conformi alle direttive di sicurezza internazionali.
Sheet holes compliant with international safety regulation.

ROUND

Design by Christophe Pillet



Scansiona e scopri i progetti.
Scan and discover the projects.

469
Poltrona
Lounge chair



Fissaggio cuscino con elastici e fermacorda.
Cushion fastening with rubber band and clip.



PRODOTTI—PRODUCTS

Codice/Code Tipologia/Typology	Disegno/Drawing	Info	TEST
-----------------------------------	-----------------	------	------

469

Poltrona
Lounge chair
W92 - D87 - H84
Kg 9,4

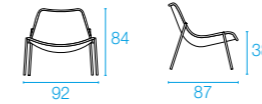

EN581-1/ EN581-2

COLORI STRUTTURA—FRAME COLORS

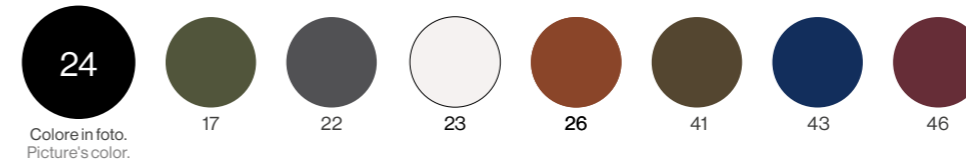

CUSCINI—CUSHIONS

Codice/Code Tipologia/Typology	Colori tessuto Fabric colors	Categoria tessuto Fabric category
C/469 Cuscino seduta e schienale acrilico Acrylic seat and back cushion x cod. 469 W110 - D80 - H3 Kg 1,3	900/71 900/75 900/77	Tessuti Standard Standard Fabrics
C/701 Cuscino decorativo—Decorative cushion x cod. 469 W40 - D40 - H15 Kg 0,7		Vedi pg. 369 Look at pg. 369 Tessuti Basic (Vedi riepilogo pg. 369) Tessuti Standard (Vedi riepilogo pg. 369) Tessuti Exclusive (Vedi riepilogo pg. 369) Basic Fabrics (Look at pg. 369) Standard Fabrics (Look at pg. 369) Exclusive Fabrics (Look at pg. 369)
C/705 Cuscino decorativo—Decorative cushion x cod. 469 W45 - D35 - H15 Kg 0,7		
C/706 Cuscino decorativo—Decorative cushion x cod. 469 W60 - D40 - H20 Kg 0,9		

ALTRI PRODOTTI IN COLLEZIONE—OTHER COLLECTION'S PRODUCTS

102



ROUND
Cod. 473
Tavolo quadrato 2/4 posti
2/4 seats square table
PAG. 210



ROUND
Cod. 475
Tavolo alto 2 posti
2 seats counter table
PAG. 212



ROUND
Cod. 477
Tavolo basso
Coffee table
PAG. 298

PLUS

• C/469 cuscino sfoderabile con imbottitura interna in poliestere e poliuretano espanso.
C/469 removable cushion cover with expanded polyurethane and polyester inner padding.

103

SEGNO

Design by Aldo Ciabatti



Scansiona e scopri i progetti.
Scan and discover the projects.

263
Sedia
Chair



268
Poltroncina
Armchair



264
Sgabello
Barstool



PRODOTTI—PRODUCTS

Codice/Code Tipologia/Typology	Disegno/Drawing	Info
-----------------------------------	-----------------	------

263 Sedia Chair W45 - D53 - H84 Kg 7,8		
--	--	--

268 Poltroncina Armchair W52 - D53 - H84 Kg 6,8		
---	--	--

264 Sgabello Barstool W50 - D54 - H102 Kg 9,0		
---	--	--

COLORI STRUTTURA—FRAME COLORS

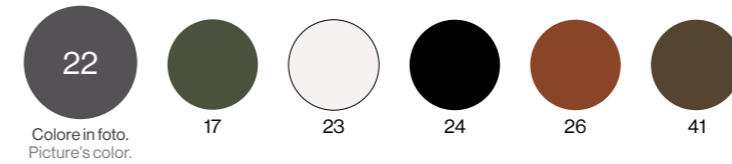

CUSCINI—CUSHIONS

Codice/Code Tipologia/Typology	Colori tessuto Fabric colors	Categoria tessuto Fabric category
C/714 Cuscino magnetico poliestere quadrato Polyester square magnetic cushion x cod. 263, 264, 268 W39 - D37 - H1,5 Kg 0,23	500/32 500/33 500/34 500/35 500/36	Tessuti Cuscini Contract Contract Cushions Fabrics
C/703 Cuscino EMU acrilico quadrato Acrylic EMU square cushion x cod. 263, 264, 268 W38 - D38 - H2 Kg 0,17	700/4 700/10 700/13* 700/32 700/34	Tessuti Basic Basic Fabrics
C/716 Cuscino universale poliestere Polyester universal cushion x cod. 263, 264, 268 W38 - D40 - H1,5 Kg 0,24	500/32 500/33 500/34 500/35 500/36	Tessuti Cuscini Contract Contract Cushions Fabrics

* Cuscino visibile in foto—Cushion in the picture

PLUS

- Sedile e schienale in lamiera zincata a caldo per una migliore resistenza agli agenti atmosferici.
Seat and backrest in hot-dip zincated sheet extremely resistant to weather conditions.
- Fessure di lamiera conformi alle direttive di sicurezza internazionali.
Sheet grooves compliant with international safety regulations.

SEGNO

Design by Aldo Ciabatti



Scansiona e scopri i progetti.
Scan and discover the projects.

267
Poltroncina con seduta in teak
Armchair with teak seat

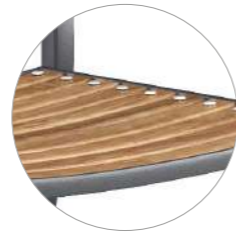

La poltroncina Segno, disponibile anche nella versione con sedile in teak FSC®, è una seduta di grande valore, ecosostenibile e durevole. The Segno armchair, also available in FSC® teak seat, is valuable, sustainable and longlasting.

158S+160B
Panca
Bench



159S+160B
Panca
Bench



PRODOTTI—PRODUCTS



Codice/Code Tipologia/Typology	Disegno/Drawing	Info	TEST
-----------------------------------	-----------------	------	------

267

Poltroncina con seduta in teak
Armchair with teak seat
W52 - D53 - H84
Kg 6,8

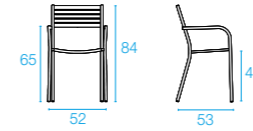

158S+160B

Panca
Bench
W128 - D59 - H81
Kg 26,2

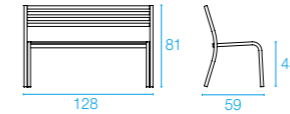

EN581-1/ EN581-2

159S+160B

Panca
Bench
W168 - D59 - H81
Kg 32,2

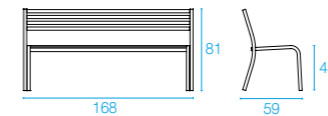

EN581-1/ EN581-2

COLORI STRUTTURA/SEDUTA COD. 267—FRAME/SEAT COLORS X COD. 267

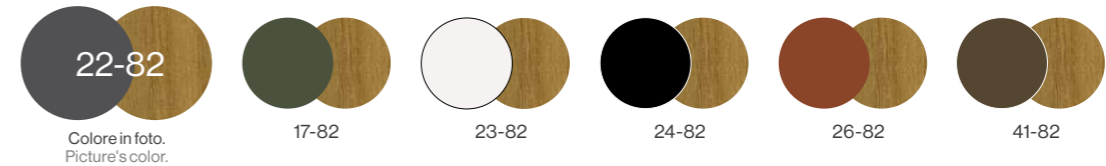

COLORI STRUTTURA X COD. 158S, 159S, 160B—FRAME COLORS X COD. 158S, 159S, 160B

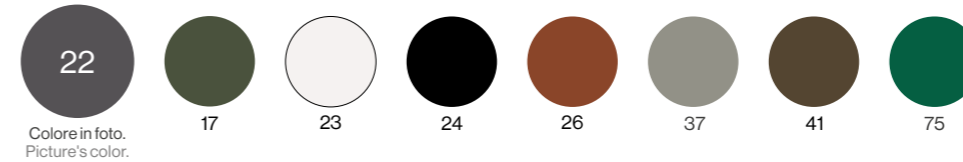

CUSCINI—CUSHIONS

Codice/Code Tipologia/Typology	Colori tessuto Fabric colors	Categoria tessuto Fabric category
-----------------------------------	---------------------------------	--------------------------------------

C/703

Cuscino EMU acrilico quadrato
Acrylic EMU square cushion
x cod. 267
W38 - D38 - H2 Kg 0,17



700/4
700/10
700/13*
700/32
700/34

Tessuti Basic
Basic Fabrics

158/F

Kit fissaggio panca—Bench fixing kit
x cod. 158, 159 Kg 0,20



COMBINAZIONI CONSIGLIATE—SUGGESTED MATCHINGS

106



STAR
Cod. 306
Tavolo quadrato 4 posti
4 seats square table
PAG. 176



PLUS4
Cod. 3484
Tavolo allungabile
Balcony 4/6+2 posti
4/6+2 seats Balcony
extensible table
PAG. 166



NOVA
Cod. 890
Tavolo alto quadrato 2 posti
2 seats counter square table
PAG. 162

107



Scansiona e scopri i progetti.
Scan and discover the projects.



247
Sedia
Chair



248
Poltroncina
Armchair



Sedile e schienale in lamiera stampata di alluminio ad alte resistenze meccaniche, ideale contro lo stress in uso tipico dei contesti contract.
Seat and backrest made of moulded aluminium sheet with high static load resistance, ideal to support the usual overload of contract contexts.



253
Sgabello
Barstool



Cuscino sfoderabile con sistema di fissaggio tramite elastico ed elemento a incastro.
Removable cushion cover with rubber band and interlocking detail fastening system.

PRODOTTI—PRODUCTS

Codice/Code Tipologia/Typology	Disegno/Drawing	Info	TEST
247 Sedia Chair W50 - D55 - H78 Kg 4,7			EN581-1/ EN581-2
248 Poltroncina Armchair W60 - D57 - H78 Kg 5,8			EN581-1/ EN581-2
253 Sgabello Barstool W54 - D57 - H97 Kg 5,7			EN581-1/ EN581-2

COLORI STRUTTURA/SEDUTA X COD. 247, 253—FRAME/SEAT COLORS X COD. 247, 253

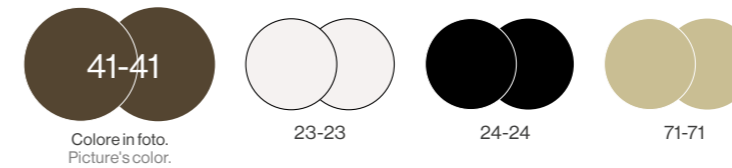

COLORI STRUTTURA/SEDUTA/BRACCIOLI X COD. 248—FRAME/SEAT/ARMRESTS COLORS X COD. 248



CUSCINI—CUSHIONS

Codice/Code Tipologia/Typology	Colori tessuto Fabric colors	Categoria tessuto Fabric category
C/247 Cuscino seduta acrilico Acrylic seat cushion x cod. 247, 248, 253 W37/40 - D40 - H2 Kg 0,3	 900/18 900/71 900/75* 900/77	Tessuti Standard Standard Fabrics
FC/1210 Cover x cod. 247, 248		

* Cuscino visibile in foto—Cushion in the picture

PLUS

- Il tubo estruso di sezione rettangolare in lega di alluminio conferisce carattere al design del prodotto.
The extruded rectangular pipe in aluminium alloy defines a specific design style.
- Cod. 248: i braccioli in teak FSC® conferiscono un piacevole effetto tattile e visivo.
Cod. 248: FSC® teak armrests give a pleasant touch, look and feel.
- C/249 cuscino in tessuto sfoderabile.—C/249 removable cushion cover.
- Viterie in acciaio inossidabile.—Stainless steel screws.



Scansiona e scopri i progetti.
Scan and discover the projects.

249
Poltrona
Lounge chair



Braccioli in teak FSC® che arricchiscono il prodotto con materiali sostenibili e dalle nuance naturali.
FSC® teak armrests enrich the product with eco-friendly materials and natural tones.

260
Divano 2 posti
2-Seater sofa



Doppio schienale piegato per agevolare il comfort in ogni posto seduta.
Double folded backrest to increase comfort of each seat.

PRODOTTI—PRODUCTS



Codice/Code Tipologia/Typology	Disegno/Drawing	Info	TEST
-----------------------------------	-----------------	------	------

249 Poltrona Lounge chair W77 - 65 - H72 Kg 7,0			EN581-1/ EN581-2
---	--	--	------------------

260 Divano 2 posti 2-Seater sofa W147 - 65 - H71 Kg 18,5			EN581-1/ EN581-2
--	--	--	------------------

COLORI STRUTTURA/SEDUTA/BRACCIOLI X COD. 249—FRAME/SEAT/ARMRESTS COLORS X COD. 249

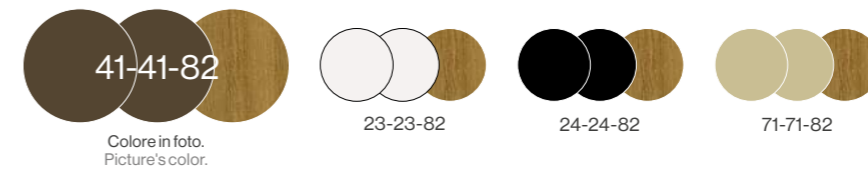

COLORI STRUTTURA E SEDUTA/BRACCIOLI X COD. 260 FRAME AND SEAT/ARMRESTS COLORS X COD. 260

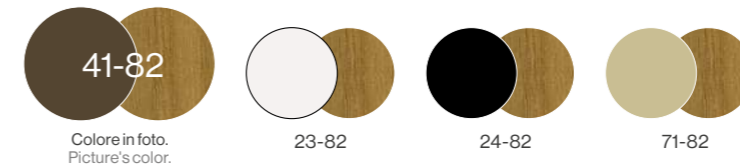

CUSCINI—CUSHIONS

Codice/Code Tipologia/Typology	Colori tessuto Fabric colors	Categoria tessuto Fabric category
C/249 Cuscino seduta acrilico Acrylic seat cushion x cod. 249, 260 W47/53 - D48 - H2 Kg 0,45	 900/18 900/71 900/75* 900/77	Tessuti Standard Standard Fabrics
FC/1216 Cover x cod. 249		
FC/1219 Cover x cod. 260		

* Cuscino visibile in foto—Cushion in the picture

PLUS

- L'intera collezione, per il suo mix di materiali, risulta particolarmente adatta per ambienti marini e imbarcazioni.—The collection, thanks to its material mix, is particularly suitable to marine environments and boats.
- I giunti dello schienale, in pressofusione di alluminio, con il loro design contribuiscono in maniera determinante all'estetica del prodotto.—The design of the die-cast aluminium backrest joints refines the aesthetics of the product.



Scansiona e scopri i progetti.
Scan and discover the projects.

247
Sedia
Chair



248
Poltroncina
Armchair



Sedile in teak FSC® per un piacevole effetto tattile e visivo.
FSC® teak seat for a pleasant touch, look and feel.

253
Sgabello
Barstool



PRODOTTI—PRODUCTS



Codice/Code Tipologia/Typology	Disegno/Drawing	Info	TEST
247 Sedia Chair W50 - D55 - H78 Kg 5,3			EN581-1/ EN581-2
248 Poltroncina Armchair W60 - D57 - H78 Kg 6,3			EN581-1/ EN581-2
253 Sgabello Barstool W54 - D57 - H97 Kg 5,9			EN581-1/ EN581-2

COLORI STRUTTURA/SEDUTA X COD. 247, 253—FRAME/SEAT COLORS X COD. 247, 253

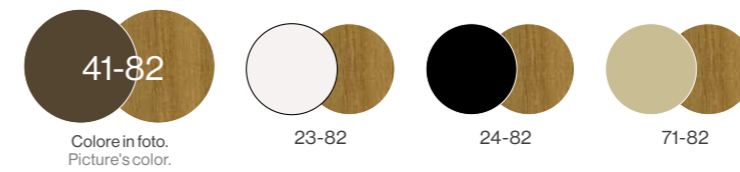

COLORI STRUTTURA/SEDUTA/BRACCIOLI X COD. 248—FRAME/SEAT/ARMRESTS COLORS X COD. 248

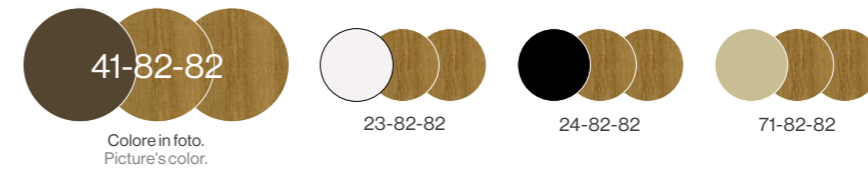

ACCESSORI—ACCESSORIES

Codice/Code Tipologia/Typology	Colori tessuto Fabric colors
FC/1210 Cover x cod. 247, 248	

PLUS

- Al caratteristico design del prodotto si aggiunge la nota naturale e sofisticata del teak che apre a un utilizzo più trasversale anche in ambienti indoor.—The natural and sophisticated teak nuance enhances the characteristic design of the product and makes the collection even more suitable to indoor spaces.
- Il sedile in teak si dimostra particolarmente performante in ambienti dai climi caldi dove si predilige tale tipo di materiale a contatto in suo con l'utilizzatore.—The seat teak version mostly fits to hot weather locations that requires no metal part touching the user.

SHINE

Design by Arik Levy



Scansiona e scopri i progetti.
Scan and discover the projects.

249
Poltrona
Lounge chair



PRODOTTI—PRODUCTS



Codice/Code Tipologia/Typology	Disegno/Drawing	Info	TEST
-----------------------------------	-----------------	------	------

249

Poltrona
Lounge chair
W77 - 65 - H72
Kg 8,5

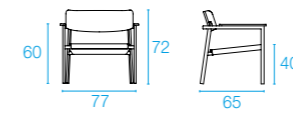

EN581-1/ EN581-2



COLORI STRUTTURA/SEDUTA/BRACCIOLI—FRAME/SEAT/ARMRESTS COLORS

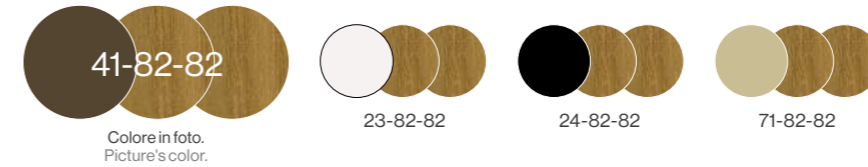

ACCESSORI—ACCESSORIES

Codice/Code Tipologia/Typology	Colori tessuto Fabric colors
FC/1216 Cover x cod. 249	

ALTRI PRODOTTI IN COLLEZIONE—OTHER COLLECTION'S PRODUCTS



SHINE
Cod. 252
Tavolo basso
Coffee table
PAG. 300



SHINE
Cod. 254+257
Tavolo 2/4 posti
con piano in teak
2/4 seats table with
teak top
PAG. 214



SHINE
Cod. 255+258
Tavolo alto 2 posti
con piano in HPL
2 seats counter table
with HPL top
PAG. 214



Scansiona e scopri i progetti.
Scan and discover the projects.

213

Poltroncina regista
Director's armchair



Sedile e schienale in EMU-Tex con imbottitura in fibra resinata per aumentarne il comfort durante l'utilizzo.
EMU-Tex seat and backrest with resin fiber padding to increase comfort during the use.



PRODOTTI—PRODUCTS

Codice/Code Tipologia/Typology	Disegno/Drawing	Info
-----------------------------------	-----------------	------

213

Poltroncina regista
Director's armchair
W61 - D60 - H80
Kg 7,8

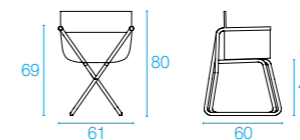

COLORI STRUTTURA/SEDUTA E SCHIENALE—FRAME/SEAT AND BACKREST COLORS

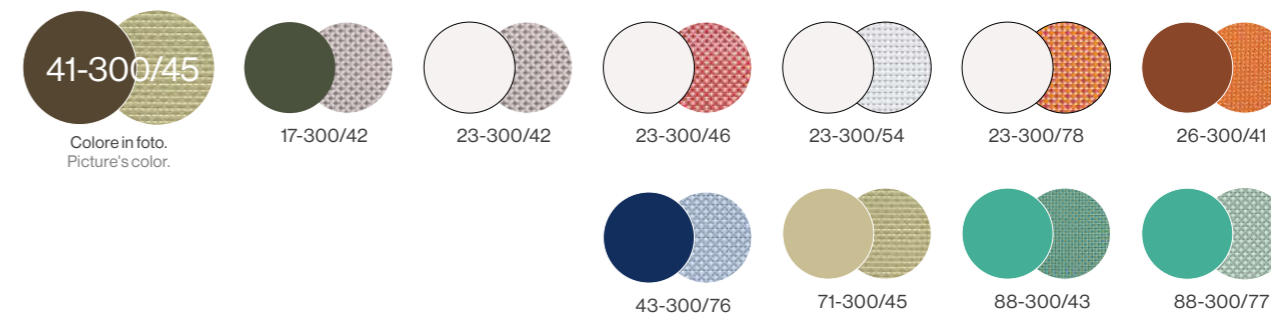

Le immagini dei colori sono a scopo illustrativo. Per vedere la trama degli EMU-Tex, consultare pg. 379.
All colors images shown are for illustration purposes only. Look at pg. 379 to see the texture of the EMU-Tex.

ALTRI PRODOTTI IN COLLEZIONE—OTHER COLLECTION'S PRODUCTS

116



SNOOZE
Cod. 201
Sdraio
Deck chair
PAG. 322



SNOOZE
Cod. 204
Poggiapiedi
Footstool
PAG. 322



SNOOZE
Cod. 207
Lettino impilabile
Stackable sunbed
PAG. 322

PLUS

- Struttura in tubolare di acciaio zincato particolarmente performante in ambienti esterni e resistente agli agenti atmosferici.
Frame in zincated tubular steel highly resistant in outdoor environments and to weather conditions.
- EMU-Tex disponibile in un'ampia gamma colori.—EMU-Tex available in a wide range of colors.
- La completezza di elementi dining e lounge rende la collezione Snooze trasversale ai più svariati contesti contract.—Snooze collection includes both dining and relaxing products being suitable to a great variety of contract contexts.

117



Scansiona e scopri i progetti.
Scan and discover the projects.



3402
Sedia
Chair

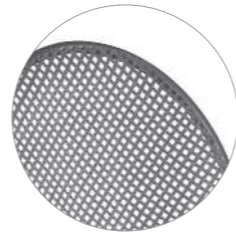

Seduta e schienale in lamiera finto intreccio zincata a caldo.
Seat and backrest in hot-dip zincated sheet with simulated woven wire mesh.

3403
Poltroncina
Armchair



Fissaggio cuscino C/704 con laccetti.
Cushion C/704 fastening with laces.

COMBINAZIONI CONSIGLIATE—SUGGESTED MATCHINGS



CAMBI
Cod. 803
Tavolo tondo 4 posti
4 seats round table
PAG. 154



TABLESYSTEM
Cod. 1156
Tavolo bordo tondo 5/6 posti
5/6 seats round edge table
PAG. 216



ATHENA
Cod. 3425P+3429B
Tavolo allungabile 8+2/4 posti
8+2/4 seats extensible table
PAG. 152

PRODOTTI—PRODUCTS

Codice/Code Tipologia/Typology	Disegno/Drawing	Info
-----------------------------------	-----------------	------

3402

Sedia
Chair
W48 - D62 - H88
Kg 5,4

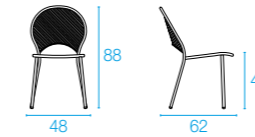

3403

Poltroncina
Armchair
W58 - D62 - H88
Kg 6,4

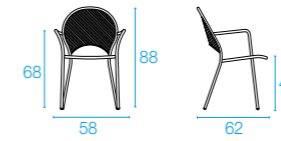

COLORI STRUTTURA—FRAME COLORS

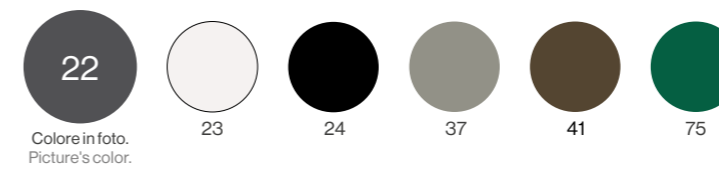

CUSCINI—CUSHIONS

Codice/Code Tipologia/Typology	Colori tessuto Fabric colors	Categoria tessuto Fabric category
C/715 Cuscino magnetico poliestere tondo Polyester round magnetic cushion x cod. 3402, 3403 ø38 - H1,5 Kg 0,17	500/32	Tessuti Cuscini Contract Contract Cushions Fabrics
	500/33	
	500/34	
	500/35	
	500/36	
C/704 Cuscino EMU acrilico tondo Acrylic EMU round cushion x cod. 3402, 3403 ø38,5 - H2 Kg 0,13	700/4	Tessuti Basic Basic Fabrics
	700/10	
	700/13*	
	700/32	
	700/34	

* Cuscino visibile in foto—Cushion in the picture

PLUS

- Lamiera saldata a proiezione per una maggiore precisione estetica.
Spot welded sheet for greater aesthetic precision.
- Cuscino magnetico C/715 in abbinamento.—C/715 matching magnetic cushion.



Scansiona e scopri i progetti.
Scan and discover the projects.

161
Sedia
Chair



Il sedile in lamiera stampata di sedia e poltroncina viene sagomato anteriormente per conferire un maggior comfort in uso.
The moulded seat of chair and armchair is frontally shaped for a greater comfort in use.

162
Poltroncina
Armchair

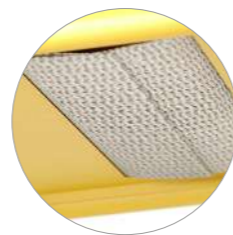

Cuscino sfoderabile C/161 con fissaggio tramite velcro.
C/161 removable cushion cover with velcro fastening.

PRODOTTI—PRODUCTS



Codice/Code Tipologia/Typology	Disegno/Drawing	Info	TEST
161 Sedia Chair W54 - D61 - H81 Kg 7,0			EN581-1/ EN581-2
162 Poltroncina Armchair W58 - D61 - H81 Kg 7,6			EN581-1/ EN581-2

COLORI STRUTTURA—FRAME COLORS

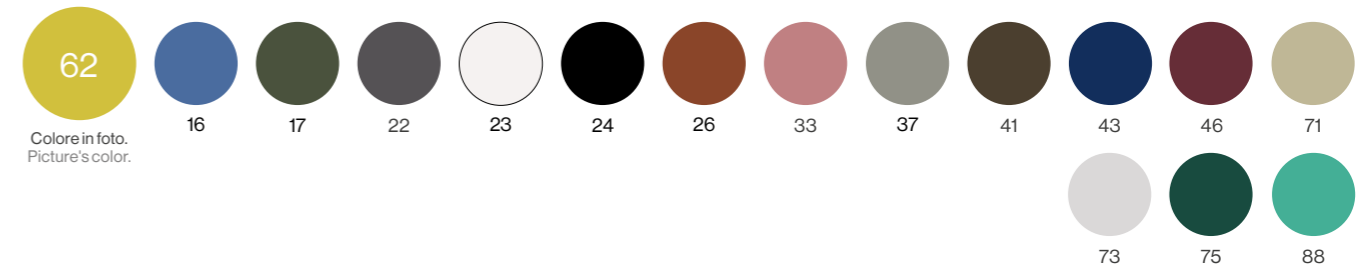

CUSCINI—CUSHIONS

Codice/Code Tipologia/Typology	Colori tessuto Fabric colors	Categoria tessuto Fabric category
C/161 Cuscino seduta acrilico Acrylic seat cushion x cod. 161, 162 W41 - D38 - H2,5 Kg 0,23		Tessuti Basic Basic Fabrics
C/162 Cuscino schienale acrilico Acrylic back cushion x cod. 161, 162 W41 - D17 - H2,5 Kg 0,13		Tessuti Basic Basic Fabrics
C/703 Cuscino EMU acrilico quadrato Acrylic EMU square cushion x cod. 161, 162 W38 - D38 - H2 Kg 0,17		Tessuti Basic Basic Fabrics
C/714 Cuscino magnetico poliestere quadrato Polyester square magnetic cushion x cod. 161, 162 W39 - D37 - H1,5 Kg 0,23		Tessuti Cuscini Contract Contract Cushions Fabrics
C/716 Cuscino universale poliestere Polyester universal cushion x cod. 161, 162 W38 - D40 - H1,5 Kg 0,24		Tessuti Cuscini Contract Contract Cushions Fabrics

* Cuscino visibile in foto—Cushion in the picture



Scansiona e scopri i progetti.
Scan and discover the projects.

164
Sgabello
Barstool



Lamiera sedile rinforzata nella parte posteriore tramite nervatura realizzata mediante stampaggio.
Reinforced seat sheet in the backpart thanks to ribbing made by moulding.

163
Panca
Bench



PRODOTTI—PRODUCTS



Codice/Code Tipologia/Typology	Disegno/Drawing	Info
-----------------------------------	-----------------	------

164 Sgabello Barstool W56 - D59 - H105 Kg 8,2		
---	--	--

163 Panca Bench W118 - D62 - H81 Kg 14,7		
--	--	--

COLORI STRUTTURA—FRAME COLORS

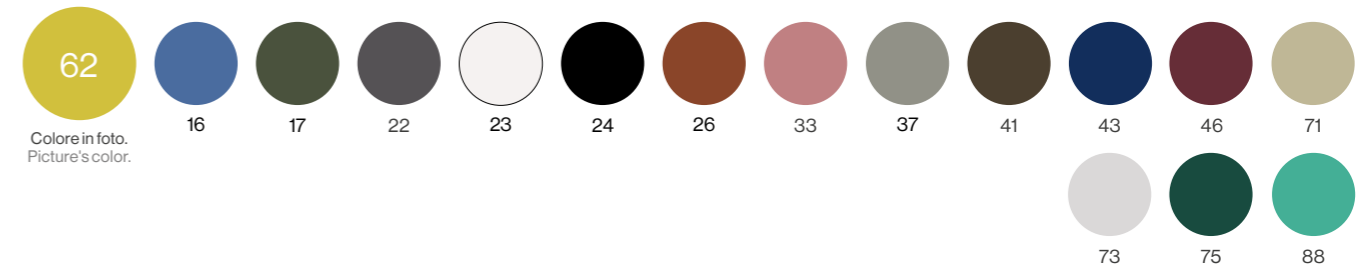

CUSCINI—CUSHIONS

Codice/Code Tipologia/Typology	Colori tessuto Fabric colors	Categoria tessuto Fabric category
C/703 Cuscino EMU acrilico quadrato Acrylic EMU square cushion x cod. 164 W38 - D38 - H2 Kg 0,17		Tessuti Basic Basic Fabrics
C/714 Cuscino magnetico poliestere quadrato Polyester square magnetic cushion x cod. 164 W39 - D37 - H1,5 Kg 0,23		Tessuti Cuscini Contract Contract Cushions Fabrics
C/716 Cuscino universale poliestere Polyester universal cushion x cod. 164 W38 - D40 - H1,5 Kg 0,24		Tessuti Cuscini Contract Contract Cushions Fabrics

PLUS

- Sedile e schienale in lamiera zincata a caldo imbutita.
Seat and backrest in deep-drawn hot-dip zincated steel sheet.
- Cuscino sfoderabile C/703 in tessuto acrilico dotato di fissaggio con laccetti. Cuscino magnetico C/714 in abbinamento. Cuscino C/716 con antiscivolo.—C/703 removable cushion cover in acrylic fabric with laces fastening. C/714 matching magnetic cushion. C/716 non-slip cushion.



Scansiona e scopri i progetti.
Scan and discover the projects.

165
Poltrona
Lounge chair



166
Divano 2 posti
2-Seater sofa



PRODOTTI—PRODUCTS



Codice/Code Tipologia/Typology	Disegno/Drawing	Info	TEST
-----------------------------------	-----------------	------	------

165 Poltrona Lounge chair W73,5 - D69,5 - H74 Kg 10,8			UNI EN 16139
---	--	--	--------------

166 Divano 2 posti 2-Seater sofa W129 - D69,5 - H74 Kg 18,4			UNI EN 16139
---	--	--	--------------

COLORI STRUTTURA—FRAME COLORS

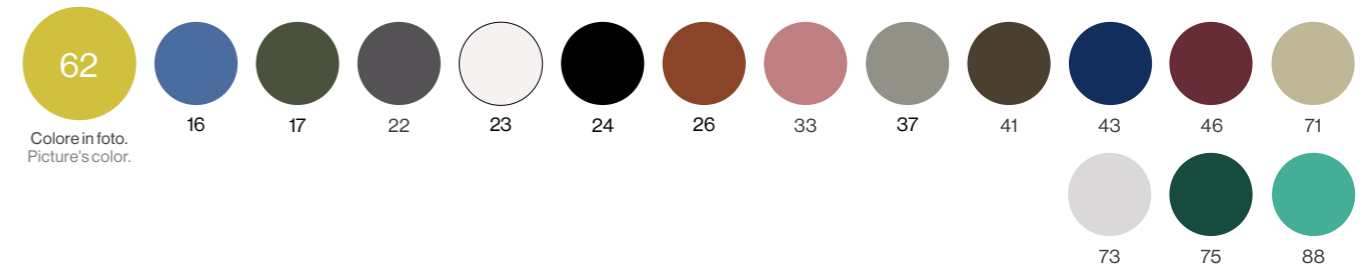

CUSCINI—CUSHIONS

Codice/Code Tipologia/Typology	Colori tessuto Fabric colors	Categoria tessuto Fabric category
C/718 Cuscino magnetico poliestere poltrona Polyester lounge chair magnetic cushion x cod. 165, 166 W53 - D44 - H1,5 Kg 0,34		Tessuti Cuscini Contract Contract Cushions Fabrics

ALTRI PRODOTTI IN COLLEZIONE—OTHER COLLECTION'S PRODUCTS



STAR
Cod. 305
Tavolo quadrato 2 posti
2 seats square table
PAG. 176



STAR
Cod. 306
Tavolo quadrato 4 posti
4 seats square table
PAG. 176



ROUND
Cod. 482
Tavolo snack
Snack table
PAG. 298

PLUS

• Cuscino magnetico C/718 per la poltrona.— C/718 lounge chair magnetic cushion.
• La completezza di elementi dining e lounge, oltre all'ampia gamma di colori disponibili, rende la collezione Star trasversale ai più svariati contesti contract.— Star collection is suitable to a great variety of contract contexts thanks to the dining and relaxing products in a wide range of colors.



Scansiona e scopri i progetti.
Scan and discover the projects.



1361
Sedia
Chair



1362
Poltroncina
Armchair



1363
Poltrona
Lounge chair



Sagomatura tramite stampo per sedia e poltrona per un maggior comfort.
Moulding shaped chair and armchair for a high comfort in use.

Struttura in lega di alluminio rinforzata internamente con tubi di acciaio zincato.
Aluminium alloy frame internally reinforced with hot-dip zincated pipes.

PRODOTTI—PRODUCTS

Codice/Code Tipologia/Typology	Disegno/Drawing	Info
1361 Sedia Chair W54 - D61 - H81 Kg 4,2		
1362 Poltroncina Armchair W58 - D61 - H81 Kg 4,6		
1363 Poltrona Lounge chair W73,5 - D69,5 - H74 Kg 6,3		

COLORI STRUTTURA—FRAME COLORS

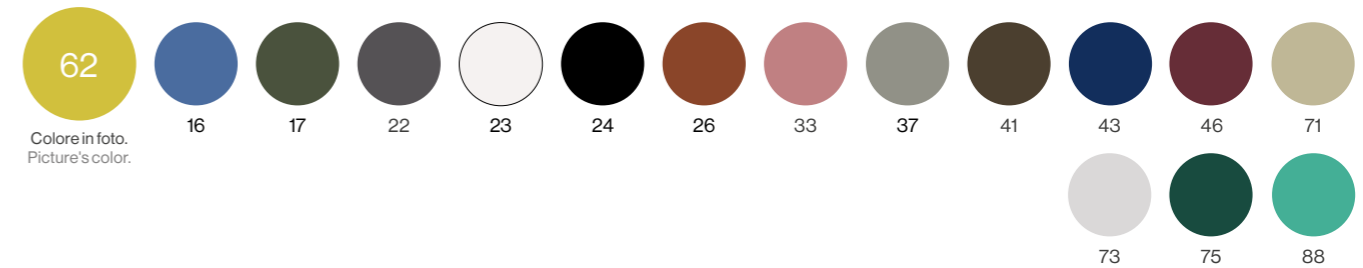

CUSCINI—CUSHIONS

Codice/Code Tipologia/Typology	Colori tessuto Fabric colors	Categoria tessuto Fabric category
C/161 Cuscino seduta acrilico Acrylic seat cushion x cod. 1361, 1362 W41 - D38 - H2,5 Kg 0,23		Tessuti Basic Basic Fabrics
C/162 Cuscino schienale acrilico Acrylic back cushion x cod. 1361, 1362 W41 - D17 - H2,5 Kg 0,13		Tessuti Basic Basic Fabrics
C/703 Cuscino EMU acrilico quadrato Acrylic EMU square cushion x cod. 1361, 1362 W38 - D38 - H2 Kg 0,17		Tessuti Basic Basic Fabrics
C/716 Cuscino universale poliestere Polyester universal cushion x cod. 1361, 1362 W38 - D40 - H1,5 Kg 0,24		Tessuti Cuscini Contract Contract Cushions Fabrics

COMBINAZIONI CONSIGLIATE—SUGGESTED MATCHINGS



GRACE
Cod. 285+286
Tavolo abbattibile bordo
quadro 2/4 posti
2/4 seats collapsible
square edge table
PAG. 202



URBAN
Cod. 090
Tavolo impilabile 4 posti
4 seats stackable table
PAG. 184



URBAN
Cod. 091
Tavolo impilabile 4/6 posti
4/6 seats stackable table
PAG. 184

PLUS

• Il nostro best seller Star evolve e diventa anche di alluminio per offrire ulteriori garanzie in prossimità di mare e piscine.— Our best seller Star has evolved in aluminium, for a higher performance near the sea and swimming pools.
• Particolarmente adeguata ad usi contract dove è richiesta maggiore resistenza e leggerezza.
It is particularly suitable to contract uses where greater strength and lightness are required.



Scansiona e scopri i progetti.
Scan and discover the projects.

728
Poltroncina
Armchair



Struttura in tubolare di alluminio e giunti in pressofusione di alluminio per un'estetica più definita.
Frame in aluminium profiles.
Die-cast aluminium joints of great finish and aesthetic refinement.



Lo schienale in eco-cuoio, con la sua flessibilità, asseconda la posizione della seduta supportandone il comfort.
The eco-leather backrest, with its flexibility, follows the position of the seat and supports comfort.



Sedile in EMU-Tex dotato di imbottitura interna per un maggior comfort.
EMU-Tex seat with inner padding for a better comfort.

PRODOTTI—PRODUCTS

Codice/Code Tipologia/Typology	Disegno/Drawing	Info	TEST
-----------------------------------	-----------------	------	------

728

Poltroncina
Armchair
W61 - D53 - H79
Kg 4,8

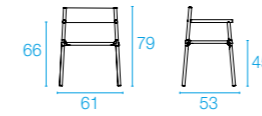

EN581-1/ EN581-2

COLORI STRUTTURA/SCHIENALE/SEDUTA—FRAME/BACK/SEAT COLORS

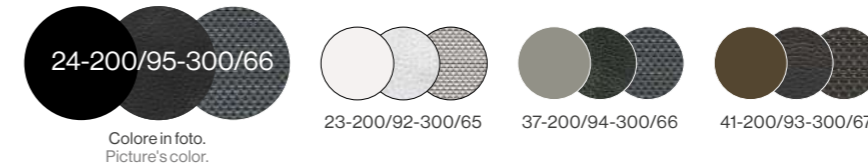

Le immagini dei colori sono a scopo illustrativo. Per vedere la trama degli EMU-Tex, consultare pg. 379.
All picture's colors are for illustration purposes only. Look at pg. 379 to see the texture of the EMU-Tex.

ALTRI PRODOTTI IN COLLEZIONE—OTHER COLLECTION'S PRODUCTS



TERRAMARE
Cod. 729+C/729
Poltrona
Lounge chair
PAG. 260



TERRAMARE
Cod. 739
Tavolo allungabile
8+2/4 posti
8+2/4 seats extensible table
PAG. 178



TERRAMARE
Cod. 733+736P
Tavolo basso medio
Medium coffee table
PAG. 302

PLUS

- Il naturale invecchiamento dell'eco-cuoio, proprio come la pelle naturale, conferisce al prodotto un carattere distintivo e affascinante.—The eco-leather recalls the beauty of natural leather and, like this one, has a natural ageing in use that increases its distinctive character and charm.
- La completezza di sedute dining e lounge, oltre alla varietà di tavoli bassi in abbinamento, rende la collezione Terramare trasversale ai più svariati contesti contract.—Terramare collection includes not only dining and lounge seating but also a wide range of coffee tables to combine with. That's why it's suitable to a great variety of contract contexts.



Scansiona e scopri i progetti.
Scan and discover the projects.

655
Sedia
Chair



La seduta Thor può essere impreziosita e resa più confortevole grazie all'applicazione del sedile in teak FSC®. Tale accessorio, dotato di un facile sistema di aggancio, conferisce valore aggiunto alla seduta sia da un punto di vista strutturale che estetico.—Thor chair could become more comfortable and elegant thanks to the teak FSC® seat available as accessory. This element, easy to fasten, gives to the seat a structural but even aesthetic added value.

657
Sgabello
Barstool



Gli sgabelli, sia alti che dining, sono dotati di un elemento in PVC di protezione poggipiedi contro i graffi, a cui il prodotto è sottoposto dopo un uso prolungato.—High and dining stools have a PVC footrest that protects the frame against scratches due to an extended use.

658
Sgabello basso
Dining stool



Cuscino C/655 in poliestere con pratico fissaggio a clip, disponibile solo per la versione in acciaio.—C/655 polyester cushion with handy clip fastening is only suitable for steel seat version.

ALTRI PRODOTTI IN COLLEZIONE—OTHER COLLECTION'S PRODUCTS



THOR
Cod. 900
Tavolo tondo 2 posti
2 seats round table
PAG. 220



THOR
Cod. 902
Tavolo tondo 2/4 posti
2/4 seats round table
PAG. 220

PRODOTTI—PRODUCTS



Codice/Code Tipologia/Typology	Disegno/Drawing	Info	TEST
655 Sedia Chair W52 - D55 - H80 Kg 6,3			EN581-1/ EN581-2
657 Sgabello Barstool W48 - D48 - H75 Kg 6,9			EN581-1/ EN581-2
658 Sgabello basso Dining stool W46 - 46 - H45 Kg 5,5			EN581-1/ EN581-2

COLORI STRUTTURA—FRAME COLORS

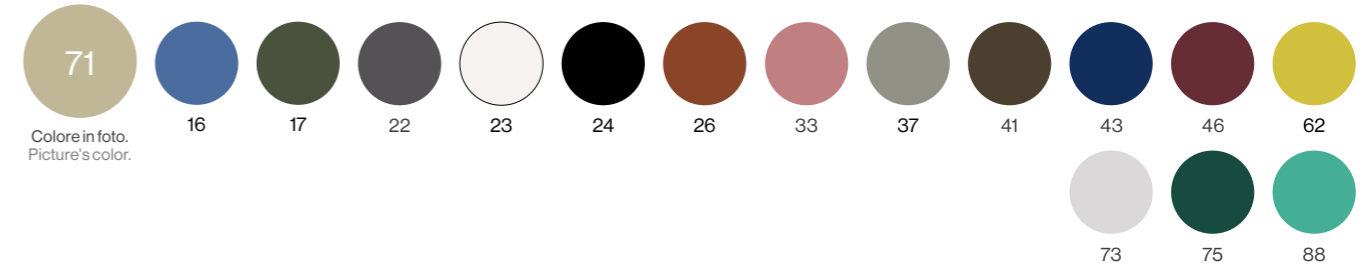

SEDILE IN TEAK/CUSCINI—TEAK SEAT/CUSHIONS

Codice/Code Tipologia/Typology	Colori tessuto Fabric colors	Categoria tessuto Fabric category
659 Sedile in teak—Teak seat x cod. 655, 657, 658 W35,5 - D35,5 - H2 Kg 1,26	82 	
C/655 Cuscino seduta poliestere (solo per seduta in acciaio) Polyester seat cushion (only for steel seat) x cod. 655, 657, 658 W37,5 - D37,5 - H1,5 Kg 0,2	500/32 500/33* 500/34 500/35 500/36	Tessuti Cuscini Contract Contract Cushions Fabrics
C/709 Cuscino universale poliestere Polyester universal cushion x cod. 655, 657, 658 W37,5 - D37,5 - H1,5 Kg 0,2	500/32 500/33 500/34 500/35 500/36	Tessuti Cuscini Contract Contract Cushions Fabrics
C/715 Cuscino magnetico poliestere tondo (solo per seduta in acciaio) Polyester round magnetic cushion (only for steel seat) x cod. 655, 657, 658 ø38 - H1,5 Kg 0,17	500/32 500/33 500/34 500/35 500/36	Tessuti Cuscini Contract Contract Cushions Fabrics

* Cuscino visibile in foto—Cushion in the picture

PLUS

• Sedile in lamiera stampata e struttura in tubo di acciaio zincato a caldo.
Moulded seat and frame made of hot-dip zincated steel pipe.

• Il design ispirato alle lavorazioni artigianali del metallo forgiato definisce il carattere di questa collezione e la rende particolarmente adatta ad ambienti contract dallo stile classico.—The design inspired by hand-forged metal crafts defines the personality of this collection and makes it especially suitable to classic contract contexts.

TWINS

Design by Sebastian Herkner



Scansiona e scopri i progetti.
Scan and discover the projects.

6051
Sedia
Chair



Il teak di sedile e schienale è modellato tridimensionalmente e conferisce alla seduta un design distintivo.
Seat and back teak is tridimensionally shaped and gives a distinctive design.

* Cuscino visibile in foto 900/02 Mare—Cushion in the picture 900/02 Sea
** Disponibile Cover FC/1210—Cover FC/1210 available

6052
Poltroncina
Armchair



Rifinito sistema di fissaggio allo schienale del cuscino C/6052.
Refined fastening system to the backrest of the C/6052 cushion.

* Cuscino visibile in foto 900/09 Salvia—Cushion in the picture 900/09 Sage
** Disponibile Cover FC/1216—Cover FC/1216 available

6053
Poltrona
Lounge chair



Cuscino in tessuto C/6053 sedile e schienale dotato di sistema di fissaggio tramite elastici e gancetti.
C/6053 seat and back cushion fastening with rubber band and hooks.

* Cuscino visibile in foto 900/77 Grigio—Cushion in the picture 900/77 Grey
** Disponibile Cover FC/1216—Cover FC/1216 available

ALTRI PRODOTTI IN COLLEZIONE—OTHER COLLECTION'S PRODUCTS



TWINS
Cod. 6062
Tavolo rettangolare 6/8 posti
6/8 seats rectangular table
PAG. 182



TWINS
Cod. 6060
Tavolo basso
Coffee table
PAG. 304



TWINS
Cod. 6055+C/6055
Divano 1 posto Teak con cuscini
1-Seater Teak sofa with cushions
PAG. 264

PRODOTTI—PRODUCTS



Codice/Code Tipologia/Typology	Disegno/Drawing	Info
6051 Sedia Chair W54 - D62 - H83,5 Kg 7,4		
6052 Poltroncina Armchair W70 - D64 - H83,5 Kg 8,9		
6053 Poltrona Lounge chair W78 - D72 - H75 Kg 9,7		

COLORI STRUTTURA/SEDUTA/BRACCIOLI—FRAME/SEAT/ARMRESTS COLORS



Colore in foto.
Picture's color.

CUSCINI—CUSHIONS

Codice/Code Tipologia/Typology	Colori tessuto Fabric colors	Categoria tessuto Fabric category
C/6051 Cuscino seduta Seat cushion x cod. 6051, 6052 W450/40 - D46 - H5 Kg 0,5		Vedi pg. 136 Look at pg. 136 Tessuti Basic (Vedi riepilogo pg. 136) Tessuti Standard (Vedi riepilogo pg. 136)* Tessuti Exclusive (Vedi riepilogo pg. 136) Basic Fabrics (Look at pg. 136) Standard Fabrics (Look at pg. 136)* Exclusive Fabrics (Look at pg. 136)
C/6052 Cuscino seduta e schienale Seat and back cushion x cod. 6051, 6052 W50/43 - D89 - H5 Kg 1,0		
C/6053 Cuscino seduta e schienale Seat and back cushion x cod. 6053 W61/49/56 - D93 - H5 Kg 1,2		

PLUS

- Collezione completa di arredi dining e lounge disponibile in versione full teak e alluminio/teak. L'esistenza di due versioni permette di mixare prodotti e materiali con stili omogenei per arredare diversi ambienti.—Twins is a complete teak and aluminium/teak collection composed of dining and lounge products. The two versions allow to furnish different spaces mixing products and materials in a coordinated style.
- Sapiente lavorazione del teak per creare un design connotante in tale segmento di mercato.—Skillful teak manufacturing that defines a distinguishing design in this market segment.
- Il prodotto in teak è maggiormente funzionale in ambienti e climi particolarmente caldi, che prediligono l'utilizzo di prodotti che non hanno metallo a contatto e ben si presta ad utilizzi in zone marine e su imbarcazioni.—Teak version mostly fits to hot weather locations that require no metal part touching the user and is particularly suitable to marine environments and boats.
- Le sedute dining possono ospitare un cuscino seduta C/6051 o un cuscino seduta e schienale C/6052. Il primo, in versione solo seduta, è dotato di un pratico sistema di fissaggio in velcro. Il secondo, nella versione sedile e schienale, viene fissato alla seduta tramite dei laccetti e allo schienale tramite asola posteriore. Entrambi sono disponibili in una vasta gamma di tessuti. C/6051 seat cushion and C/6052 seat and back cushion can dress the dining seats. The first one has a handy velcro fastening system, the second one is fastened to the seat with laces and to the back with a fabrics rear bend. They are both available in a wide fabric range.
- Sottopiedi in nylon.—Nylon feet.

TWINS

Design by Sebastian Herkner



Scansiona e scopri i progetti.
Scan and discover the projects.

6040
Sedia
Chair

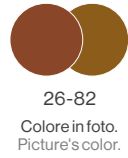

Il teak di sedile e schienale è modellato tridimensionalmente e conferisce alla seduta un design distintivo.
Seat and back teak is tridimensionally shaped gives a distinctive design.

* Cuscino visibile in foto 900/07 Avana—Cushion in the picture 900/07 Chesnut
** Disponibile Cover FC/1210—Cover FC/1210 available

6041
Poltroncina
Armchair



Ergonomia di sedile e schienale che garantisce uno straordinario comfort.
Ergonomic seat and back that ensure an extreme comfort.

** Disponibile Cover FC/1216—Cover FC/1216 available

6042
Poltrona
Lounge chair

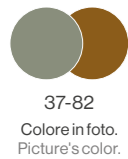

Bracciolo in teak FSC® massello sostituibile in caso di danneggiamento.
Solid teak FSC® armrest that could be replaced in case of damage.

* Cuscino visibile in foto 900/09 Salvia—Cushion in the picture 900/09 Sage
** Disponibile Cover FC/1216—Cover FC/1216 available

PRODOTTI—PRODUCTS



Codice/Code Tipologia/Typology	Disegno/Drawing	Info
6040 Sedia Chair W54 - D62 - H83,5 Kg 7,3		
6041 Poltroncina Armchair W70 - D64 - H83,5 Kg 8,2		
6042 Poltrona Lounge chair W785 - D72 - H75 Kg 9,1		

COLORI STRUTTURA/SEDUTA/BRACCIOLI—FRAME/SEAT/ARMRESTS COLORS

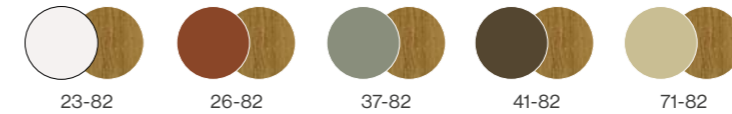

CUSCINI—CUSHIONS

Codice/Code Tipologia/Typology	Colori tessuto Fabric colors	Categoria tessuto Fabric category
C/6051 Cuscino seduta Seat cushion x cod. 6040,6041 W450/40 - D46 - H5 Kg 0,5		Tessuti Basic (Vedi riepilogo pg. 136) Tessuti Standard (Vedi riepilogo pg. 136)* Tessuti Exclusive (Vedi riepilogo pg. 136) Basic Fabrics (Look at pg. 136) Standard Fabrics (Look at pg. 136)* Exclusive Fabrics (Look at pg. 136)
C/6052 Cuscino seduta e schienale Seat and back cushion x cod. 6040,6041 W50/43 - D89 - H5 Kg 1,0		
C/6053 Cuscino seduta e schienale Seat and back cushion x cod. 6042 W61/49/56 - D93 - H5 Kg 1,2		

PLUS

- I prodotti di questa collezione, per i materiali usati e le loro geometrie, creano eleganti mix&match con altri prodotti del catalogo.— These products can be finely mixed to other EMU furniture thanks to their materials and shapes.
- Sedute maneggevoli, leggere e resistenti grazie all'utilizzo dell'alluminio.
Handy, light but strong seat collection due to the aluminium frame.
- Viti di fissaggio in acciaio inossidabile, a scomparsa, per un design ricercato e dai particolari eleganti.
Stainless steel hidden screws for elegant details and design.
- Le doghe in legno di sedile e schienale, incorniciate nel profilo di struttura perimetrale in alluminio, mixano il colore naturale del teak a quello del metallo verniciato, per creare un effetto cromatico ricercato.
Teak back and seat slats are framed in the aluminium perimeter structural profile and mix the natural teak tone to colored metal to create a refined chromatic effect.
- Facile sostituibilità delle doghe in teak e dei braccioli in caso di danneggiamento.
Easy replacement of teak slats and armrests in case of damage.
- Molatura di tutte le saldature esterne per una migliore pulizia dei dettagli.
Grinded external weldings to more essential details.
- Facile separazione dei componenti per una corretta raccolta differenziata e uno smaltimento green a fine vita.
Easy dismantlement of different components for a correct recycling and ecological disposal.



TESSUTI CUSCINI — CUSHION FABRICS C/6051 - C/6052 - C/6053

Composizione/Categoria tessuti Composition/Fabrics category	Colori Colors
TESSUTI BASIC — BASIC FABRICS	
Acrilico — Acrylic	700/4
	700/10
	700/13
	700/32
	700/34
TESSUTI STANDARD — STANDARD FABRICS	
88% Acrilico, 12% Poliestere — 88% Acrylic, 12% Polyester	900/02
	900/05
	900/07
	900/08
	900/09
	900/18
	900/71
	900/75
	900/77
	Acrilico — Acrylic
TESSUTI EXCLUSIVE — EXCLUSIVE FABRICS	
CAT. E Visitare il nostro sito web www.emu.it — Visit our website www.emu.it	600/31
	600/32
	600/33
	600/34
	600/35
	600/36
	600/37
	600/38
	600/39
	600/40
	600/41
	600/42
	600/43
CAT. D Visitare il nostro sito web www.emu.it — Visit our website www.emu.it	600/48
	600/49
	600/27
CAT. C Visitare il nostro sito web www.emu.it — Visit our website www.emu.it	900/16
	600/07
	600/14
CAT. B Visitare il nostro sito web www.emu.it — Visit our website www.emu.it	600/16
	600/18
	600/11
CON TESSUTO CLIENTE — WITH CUSTOMER'S FABRIC	
FABBISOGNO TESSUTO (cm) — FABRIC REQUIRED (cm)	C/6051 132x42, C/6052 132x82, C/6053 132x95



URBAN

Design by Samuel Wilkinson



Scansiona e scopri i progetti.
Scan and discover the projects.

208
Sedia
Chair



209
Poltroncina
Armchair



Il tubolare di alluminio a sezione quadrata connota il carattere di questa linea di sedute.
The square aluminium profile characterizes the design of seats.

PRODOTTI—PRODUCTS

Codice/Code Tipologia/Typology	Disegno/Drawing	Info	TEST
-----------------------------------	-----------------	------	------

208 Sedia Chair W51 - D55 - H81 Kg 4,1			EN581-1/ EN581-2
--	--	--	------------------

209 Poltroncina Armchair W56 - D55 - H81 Kg 4,5			EN581-1/ EN581-2
---	--	--	------------------

COLORI STRUTTURA—FRAME COLORS

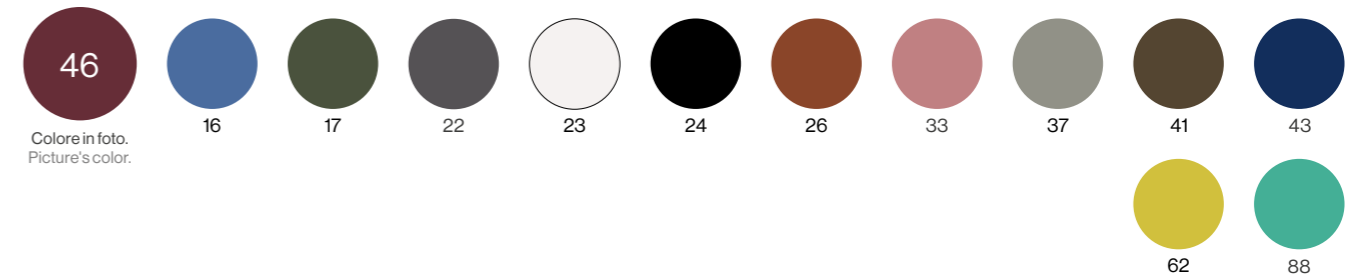

CUSCINI—CUSHIONS

Codice/Code Tipologia/Typology	Colori tessuto Fabric colors	Categoria tessuto Fabric category
C/703 Cuscino EMU acrilico quadrato Acrylic EMU square cushion x cod. 208, 209 W38 - D38 - H2 Kg 0,17		Tessuti Basic Basic Fabrics
C/716 Cuscino universale poliestere Polyester universal cushion x cod. 208, 209 W38 - D40 - H1,5 Kg 0,24		Tessuti Cuscini Contract Contract Cushions Fabrics

* Cuscino visibile in foto—Cushion in the picture

ALTRI PRODOTTI IN COLLEZIONE—OTHER COLLECTION'S PRODUCTS

138



URBAN
Cod. 096
Tavolo impilabile 2/4 posti
2/4 seats stackable table
PAG. 184



URBAN
Cod. 090
Tavolo impilabile 4 posti
4 seats stackable table
PAG. 184



URBAN
Cod. 091
Tavolo impilabile 4/6 posti
4/6 seats stackable table
PAG. 184

PLUS

- Il design minimale e l'estrema leggerezza sono i due punti di forza di questa collezione e la rendono trasversale ai più svariati contesti contract.— Minimal design and great lightness are the two most relevant differentiating features of this collection and make it suitable to a great variety of contract contexts.
- Schienale e sedile in lamiera stampata di alluminio con sagomatura della seduta per un comfort migliore. Backrest and seat in moulded aluminium sheet. Shaped seat to improve comfort.
- Cuscino acrilico sfoderabile C/703, fissaggio con laccetti. C/703 acrylic removable cushion cover with laces fastening.
- Cuscino C/716 con antiscivolo.— C/716 cushion with anti-slip system.

139



Scansiona e scopri i progetti.
Scan and discover the projects.



500
Sedia
Chair



Seduta e schienale realizzati con cinghie in fibra di polipropilene e fili di gomma sintetica. Questo materiale conferisce al prodotto grande comfort, leggerezza e maneggevolezza.

Aluminium frame with seat and backrest made with polypropylene fibers and synthetic rubber threads. This material makes the product extremely comfortable, light and easy to handle.

501
Poltroncina
Armchair



533
Sgabello
Barstool



Copertura poggiapiedi dello sgabello in acciaio inossidabile per proteggere la struttura tubolare da graffi.
The stool has a stainless steel footrest cover for protection against scratching.

PRODOTTI—PRODUCTS

Codice/Code Tipologia/Typology	Disegno/Drawing	Info	TEST
500 Sedia Chair W51 - D57 - H81 Kg 2,6			EN581-1/ EN581-2
501 Poltroncina Armchair W58 - D55 - H81 Kg 3,2			EN581-1/ EN581-2
533 Sgabello Barstool W50,5 - D50,5 - H95 Kg 3,3			

COLORI STRUTTURA/SEDUTA E SCHIENALE—FRAME/SEAT AND BACKREST COLORS

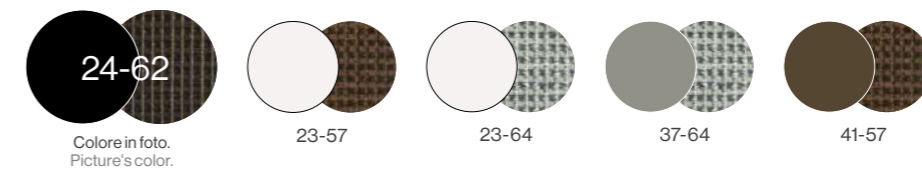

Le immagini dei colori sono a scopo illustrativo. Per vedere la trama delle cinghie elastiche, consultare pg. 380.
All picture's colors are for illustration purposes only. Look at pg. 380 to see the texture of the elastic belts.

PLUS

- L'intreccio delle cinghie rende la seduta flessibile e ne assicura il comfort senza necessità di un cuscino addizionale.—The elastic belts net makes the seat adapting and ensures comfort without cushion.
- Tubolare di alluminio che slancia visivamente la struttura.—Aluminium pipes frame that visually stands out.
- L'intera collezione, per il suo mix di materiali, risulta particolarmente adatta in ambienti marini e su imbarcazioni.—The whole collection is particularly suitable to marine environments and boat thank to the material mix.
- La collezione, con gli elementi lounge, si completa e può arredare diversi ambienti e diverse destinazioni d'uso all'interno di uno stesso spazio contract con stile coordinato.—Lounge elements make the collection complete and suitable to furnish several contexts and different areas in the same contract environment with a coordinated style.



Scansiona e scopri i progetti.
Scan and discover the projects.

503
Poltrona
Lounge chair



Sistema di fissaggio cinghie brevettato EMU. I tubolari di seduta e schienale hanno un canale interno che permette l'inserimento delle varie cinghie, il loro intreccio e il fissaggio. Tale sistema, risultato di una specifica soluzione tecnica originale EMU, permette la sostituzione delle cinghie in caso di danneggiamento.
Belt fastening system patented by EMU. The seat and back tubular have an internal channel that allows the insertion of the various belts, their interlacing and fixing. This system, the result of a specific original EMU technical solution, allows the replacement of belts in case of damage.

531
Divano 2 posti
2-Seater sofa



PRODOTTI—PRODUCTS

Codice/Code Tipologia/Typology	Disegno/Drawing	Info	TEST
503 Poltrona lounge chair W73 - D71,5 - H77 Kg3,6			EN581-1/ EN581-2
531 Divano 2-Seater sofa W139 - D71,5 - H77 Kg7,8			

COLORI STRUTTURA/SEDUTA E SCHIENALE—FRAME/SEAT AND BACKREST COLORS

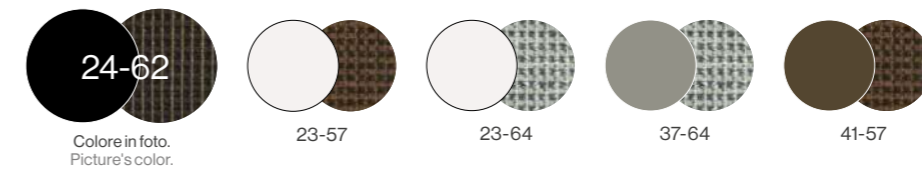

Le immagini dei colori sono a scopo illustrativo. Per vedere la trama delle cinghie elastiche, consultare pg. 380.
All picture's colors are for illustration purposes only. Look at pg. 380 to see the texture of the elastic belts.

ALTRI PRODOTTI IN COLLEZIONE—OTHER COLLECTION'S PRODUCTS



YARD
Cod. 504
Lettino impilabile
Stackable sunbed
PAG. 330



YARD
Cod. 509
Tavolo basso
Coffee table
PAG. 306



YARD
Cod. 505
Tavolo rettangolare 6 posti
6 seats rectangular table
PAG. 186



MIA—LOUVRE MUSEUM BISTROT—UNITED ARAB EMIRATES



RE-TROUVÉ—TNT HOOFFDORP—HOLLAND

EMU NEL MONDO EMU IN THE WORLD



THOR—INES BEER-B-Q—ITALY



TAVOLI A 4 GAMBE 4-LEGGED TABLES

Allungabili, impilabili, di differenti altezze, colori e abbinamenti: EMU offre un'ampia scelta di tavoli a 4 gambe che soddisfano i massimi requisiti qualitativi in termini di resistenza, estetica e funzionalità. Il design trasversale di questi tavoli è studiato per creare diversi abbinamenti con le varie sedute EMU. Inoltre, i piani sono realizzati con materiali innovativi e possono avere più dimensioni e forme, mentre le gambe, autolivellanti o con sottopiede regolabile, assicurano comfort e stabilità sulle superfici irregolari.

Extensible, stackable, with different heights, colors and combinations: EMU offers a wide range of high-quality, aesthetically pleasing and functional 4-legged tables. The concept design behind is to create many combinations with EMU seating collections. Furthermore, the innovative materials used for the table tops come in numerous sizes and shapes, whereas the self levelling legs or legs with adjustable feet ensure comfort and stability especially on uneven surfaces.

INDEX

LEGENDA—LEGEND
● Acciaio—Steel
● Alluminio—Aluminium
● Legno—Wood

148	ANGEL	●
150	ARC EN CIEL	●
152	ATHENA ☐	●
154	CAMBI	●
160	NOVA	●
164	PIGALLE	●
166	PLUS4 ☐	●
170	QUADRO	●
172	ROUND ☐	●
174	SHINE ☐	● ●
176	STAR	●
178	TERRAMARE ☐	●
182	TWINS	●
184	URBAN	●
186	YARD ☐	●

☐ Tavoli allungabili—Extensible tables



Scansiona e scopri i progetti.
Scan and discover the projects.

9051
Tavolo tondo 6 posti
6 Seats round table



Piani dagli angoli sagomati per una maggiore fruibilità e finitura estetica più elevata.
Tops with shaped corners for greater usability and higher aesthetic finish.

9053
Tavolo rettangolare 8 posti
8 seats rectangular table



Sezione caratteristica del giunto di struttura.
Characteristic profile of the structural joint.

PRODOTTI—PRODUCTS



Codice/Code Tipologia/Typology	Disegno/Drawing	Info
-----------------------------------	-----------------	------

9051
Tavolo tondo 6 posti
6 Seats round table
ø149 - H75
Kg 35,6

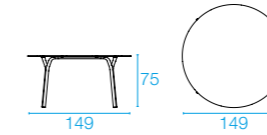

9053
Tavolo rettangolare
8 posti
8 Seats rectangular table
W214 - D103 - H75
Kg 42,7

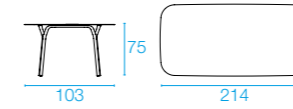

COLORI STRUTTURA—FRAME COLORS

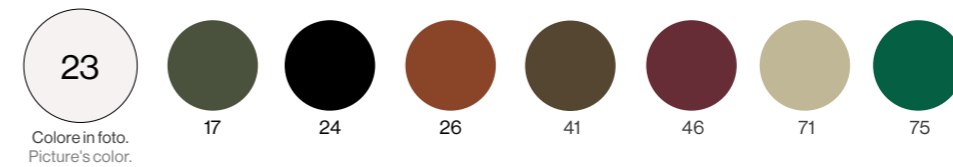

PLUS

- Struttura dall'estetica caratterizzante grazie al design del profilo di alluminio esclusivo EMU.
Characterizing aesthetics frame thanks to the design of the exclusive EMU aluminum profile.
- Ispirazione neoclassica che qualifica la collezione per differenti destinazioni d'uso di tipologia contract, sia dining che lounge.
Neoclassical inspiration that qualifies the collection for different contract uses, whether dining or lounge.



Scansiona e scopri i progetti.
Scan and discover the projects.



PRODOTTI—PRODUCTS

Codice/Code Tipologia/Typology	Disegno/Drawing	Info
-----------------------------------	-----------------	------

331
Tavolo pieghevole 4 posti
4 seats folding table



331
Tavolo pieghevole
4 posti
4 seats folding table
W110 - D70 - H74
Kg 16,4

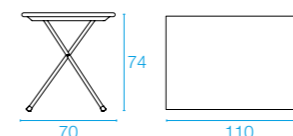

334
Tavolo pieghevole 2 posti
2 seats folding table



334
Tavolo pieghevole
2 posti
2 seats folding table
W70 - D50 - H74
Kg 8,1

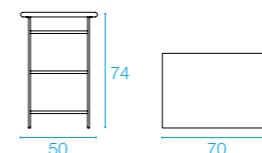

Piano in lamiera zincata piegata per garantire un bordo arrotondato e spigoli smussati.
Table with bent hot-dip zined sheet top to ensure rounded and smooth edges.

346
Tavolo pieghevole
2/4 posti
2/4 seats folding table
ø80 - H74
Kg 10,1

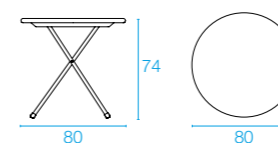

346
Tavolo pieghevole 2/4 posti
2/4 seats folding table



364
Tavolo pieghevole
4/6 posti
4/6 seats folding table
W160 - D80 - H74
Kg 26,5

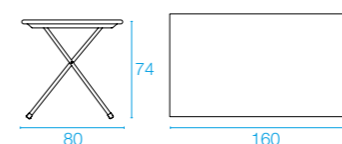

COLORI STRUTTURA—FRAME COLORS

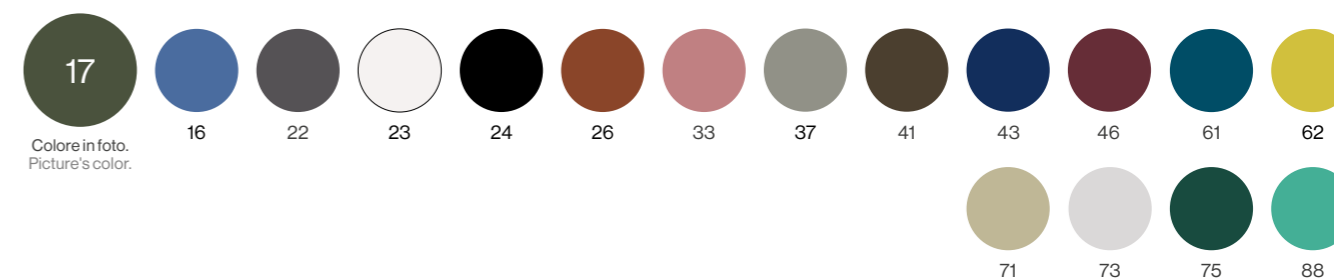

364
Tavolo pieghevole 4/6 posti
4/6 seats folding table



PLUS

- Il bloccaggio delle gambe evita la chiusura accidentale e garantisce stabilità.
Legs locking prevents accidental closure and ensures stability.
- Ampia gamma di colori disponibili.—Wide colors range.
- Tavoli pieghevoli per un rimessaggio facile e salvaspazio.
Folding tables for an easy and space-saving storage.
- Le varie misure disponibili permettono di servire le differenti esigenze di spazio degli ambienti contract, sia indoor che outdoor.—The various available sizes meet the different needs of indoor and outdoor contract environments.



Scansiona e scopri i progetti.
Scan and discover the projects.



3425P+3429B
Tavolo allungabile 8+2/4 posti
8+2/4 seats extensible table

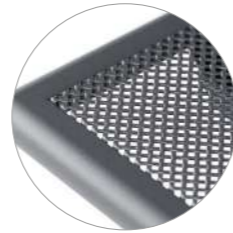

Piano in lamiera zincata a caldo, con motivo finto intreccio.
Simulated woven hot-dip zincated sheet.

3428P+3429B
Tavolo allungabile 6+2 posti
6+2 seats extensible table



La prolunga in lamiera piena prezincata a caldo è dotata di foro centrale per ombrellone.
The hot-dip zincated extension has a central hole for sunshade.

PRODOTTI—PRODUCTS

Codice/Code Tipologia/Typology	Disegno/Drawing	Info
-----------------------------------	-----------------	------

3425P+3429B

Tavolo allungabile
8+2/4 posti
8+2/4 seats
extensible table
W230+70 - D100 - H75
Kg 63,5

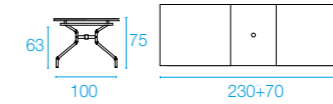

3428P+3429B

Tavolo allungabile
6+2 posti
6+2 seats
extensible table
W160+50 - D90 - H75
Kg 44,3

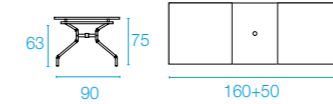

COLORI STRUTTURA—FRAME COLORS

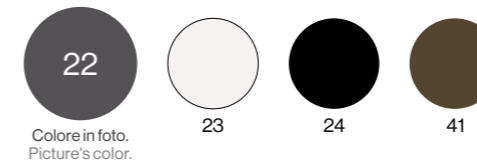

Colore in foto.
Picture's color.

PLUS

- Il design intramontabile di questa linea di tavoli li rende trasversali e combinabili a una varietà di sedute dallo stile classico.—The timeless design of this table collection make them matchable and consistent to several classic seat collections.
- I tavoli si aprono agevolmente facendo scorrere lateralmente il piano ed estraendo la prolunga interna tramite un pratico meccanismo a farfalla.—These tables can be easily opened rolling the top and getting out the internal extension by a butterfly mechanism.
- Il tavolo cod. 3428P+3429B può ospitare 6+2 posti tavola, il tavolo cod. 3425P+3429B 8+2 posti tavola. Cod. 3428P+3429B table can have 6+2 seats, cod. 3425P+3429B 8+2 seats.



Scansiona e scopri i progetti.
Scan and discover the projects.

800
Tavolo quadrato 2 posti
2 seats square table



801
Tavolo quadrato 2/4 posti
2/4 seats square table



802
Tavolo quadrato 4 posti
4 seats square table



803
Tavolo tondo 4 posti
4 seats round table

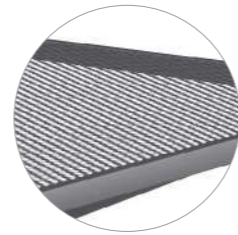

Lamiera stirata zincata a caldo.
Hot-dip zincated sheet.



Gambe in tubo di acciaio zincato a caldo la cui piegatura consente di avere spazio per il rimessaggio della seduta sotto il tavolo, riducendo ingombro a terra.
The bended lower legs in hot-dip zincated steel pipes allows optimize the usable space under the top but also on the floor.

PRODOTTI—PRODUCTS



Codice/Code Tipologia/Typology	Disegno/Drawing	Info
800 Tavolo quadrato 2 posti 2 seats square table W60 - D60 - H75 Kg 11,2		
801 Tavolo quadrato 2/4 posti 2/4 seats square table W80 - D80 - H75 Kg 14,9		
802 Tavolo quadrato 4 posti 4 seats square table W90 - D90 - H75 Kg 16,8		
803 Tavolo tondo 4 posti 4 seats round table ø80 - H75 Kg 12,0		

COLORI STRUTTURA—FRAME COLORS

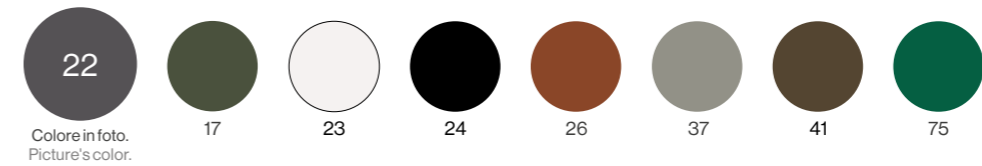

PLUS

- Il design intramontabile di questa linea di tavoli li rende particolarmente adatti ad ambienti contract dallo stile classico, sia indoor che outdoor.—The timeless design of these tables makes them suitable to classic indoor and outdoor contract contexts.
- Le varie misure disponibili permettono di servire le differenti esigenze di spazio.
The various available sizes meet the different space needs.
- Rete con grandezza fori conformi a direttive di sicurezza internazionali.
Holes mesh sheet compliant with international safety regulation.
- Il tavolo cod.809 può ospitare 6 posti tavola, il tavolo cod. 810 fino a 8 posti tavola.
Cod.809 table can have 6 seats, cod. 810 up to 8 seats.
- La piegatura e la forma delle gambe fa sì che l'ingombro sotto il tavolo possa essere sfruttato a pieno e confortevolmente.—The bended lower legs optimize the usable space under the top and make it comfortable.



Scansiona e scopri i progetti.
Scan and discover the projects.



804
Tavolo tondo 5 posti
5 seats round table



805
Tavolo tondo 6 posti
6 seats round table



807
Tavolo rettangolare 4/6 posti
4/6 seats rectangular table



808
Tavolo rettangolare 6 posti
6 seats rectangular table



Sottopiede regolabile per una migliore stabilità su superfici irregolari.
Adjustable feet for a higher stability on uneven surfaces.

PRODOTTI—PRODUCTS

Codice/Code Tipologia/Typology	Disegno/Drawing	Info
804 Tavolo tondo 5 posti 5 seats round table ø106 - H75 Kg 16,2		
805 Tavolo tondo 6 posti 6 seats round table ø120 - H75 Kg 19,0		
807 Tavolo rettangolare 4/6 posti 4/6 seats rectangular table W120 - D80 - H75 Kg 18,3		
808 Tavolo rettangolare 6 posti 6 seats rectangular table W140 - D80 - H75 Kg 20,5		

COLORI STRUTTURA—FRAME COLORS

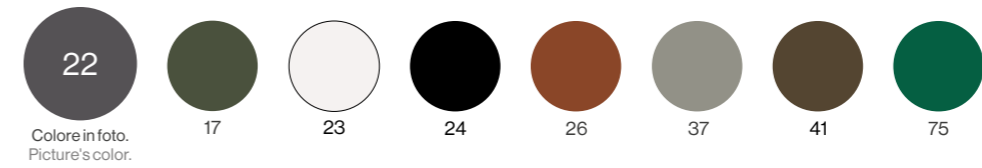



Scansiona e scopri i progetti.
Scan and discover the projects.

809
Tavolo rettangolare 6/8 posti
6/8 seats rectangular table



810
Tavolo rettangolare 8 posti
8 seats rectangular table



Foro centrale per palo ombrellone.
Central hole for the sunshade.

PRODOTTI—PRODUCTS



Codice/Code Tipologia/Typology	Disegno/Drawing	Info
-----------------------------------	-----------------	------

809
Tavolo rettangolare 6/8 posti
6/8 seats rectangular table
W160 - D80 - H75
Kg 23,2

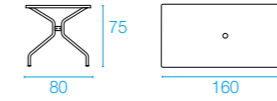

810
Tavolo rettangolare 8 posti
8 seats rectangular table
W180 - D80 - H75
Kg 25,4

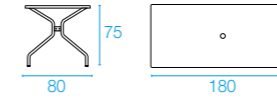

COLORI STRUTTURA—FRAME COLORS

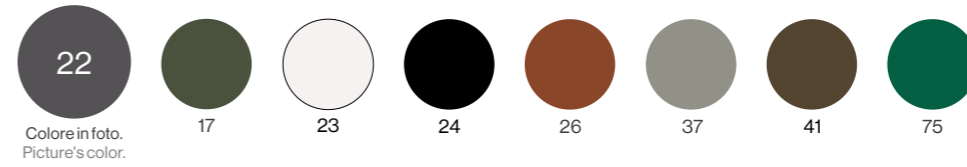



Scansiona e scopri i progetti.
Scan and discover the projects.



857
Tavolo quadrato impilabile 2/4 posti
2/4 seats stackable square table



858
Tavolo quadrato impilabile 2 posti
2 seats stackable square table



859
Tavolo quadrato impilabile 4 posti
4 seats stackable square table



854
Tavolo rettangolare impilabile
4/6 posti
4/6 seats stackable rectangular table



Gambe smontabili e imballo salvaspazio per i cod. 859, 854 e per i tavoli alti.
The products cod. 859, 854 and the counter tables have removable legs and space-saving packaging.

PRODOTTI—PRODUCTS

Codice/Code Tipologia/Typology	Disegno/Drawing	Info	TEST
857 Tavolo quadrato impilabile 2/4 posti 2/4 Seats stackable square table W80 - D80 - H74 Kg 14,0			EN581-1/ EN581-3
858 Tavolo quadrato impilabile 2 posti 2 seats stackable square table W70 - D70 - H74 Kg 11,8			EN581-1/ EN581-3
859 Tavolo quadrato impilabile 4 posti 4 seats stackable square table W90 - D90 - H74 Kg 18,9			
854 Tavolo rettangolare impilabile 4/6 posti 4/6 seats stackable rectangular table W120 - D80 - H74 Kg 24,0			

COLORI STRUTTURA—FRAME COLORS

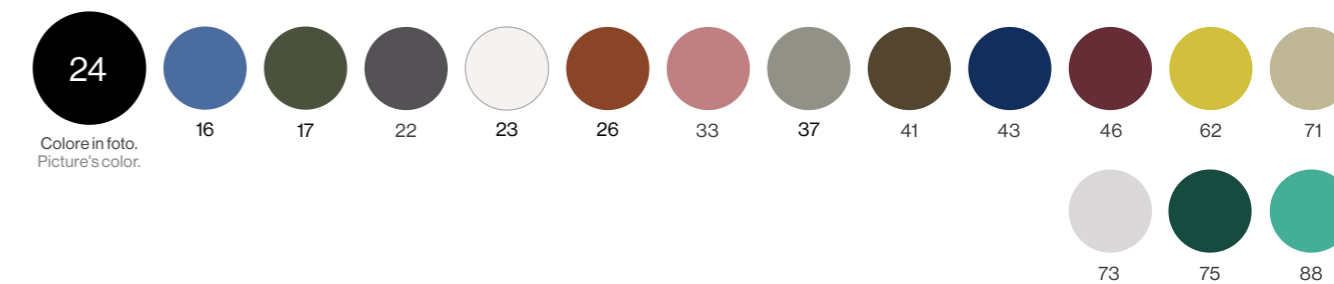

PLUS

- I tavoli dining hanno un piano autolivellante che garantisce grande stabilità anche sulle superfici più irregolari.—Self-levelling dining tables that guarantee great stability also on the most uneven surfaces.
- I tavoli alti sono dotati di piedini regolabili.—The counter tables have 4 adjustable feet.
- Ampia gamma di colori disponibili.—Wide colors range.
- Piano pieno in lamiera zincata a caldo che permette un'agevole pulizia grazie alla planarità del piano stesso.—Hot-dip zincated sheet top that creates an easy to clean even surface.
- I tavoli cod. 859, 854, 890, 891, 892, 893, 894 sono imballati singolarmente.
Tables cod. 859, 854, 890, 891, 892, 893, 894 have single packing.
- Ampia offerta di misure per renderli idonei a tutti gli spazi.
Tables available in different sizes to make them suitable to all spaces.



Scansiona e scopri i progetti.
Scan and discover the projects.



890
Tavolo alto quadrato 2 posti
2 seats counter square table



891
Tavolo alto quadrato 2/4 posti
2/4 seats counter square table



892
Tavolo alto quadrato 4 posti
4 seats counter square table



893
Tavolo alto rettangolare 4 posti
4 seats counter rectangular table



894
Tavolo alto rettangolare 4/6 posti
4/6 seats counter rectangular table



PRODOTTI—PRODUCTS

Codice/Code Tipologia/Typology	Disegno/Drawing	Info
890 Tavolo alto quadrato 2 posti 2 seats counter square table W70 - D70 - H105 Kg 18,0		
891 Tavolo alto quadrato 2/4 posti 2/4 seats counter square table W80 - D80 - H105 Kg 20,0		
892 Tavolo alto quadrato 4 posti 4 seats counter square table W90 - D90 - H105 Kg 22,0		
893 Tavolo alto rettangolare 4 posti 4 seats counter rectangular table W120 - D70 - H105 Kg 22,5		
894 Tavolo alto rettangolare 4/6 posti 4/6 seats counter rectangular table W120 - D80 - H105 Kg 23,8		

COLORI STRUTTURA—FRAME COLORS

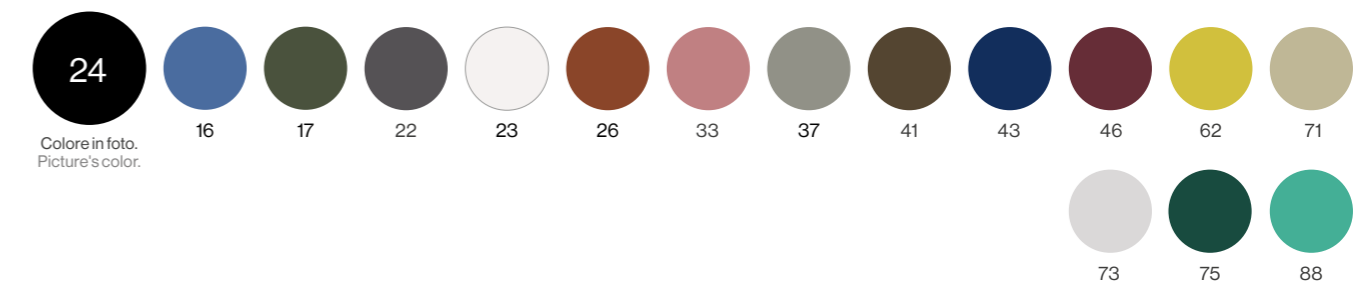



Scansiona e scopri i progetti.
Scan and discover the projects.



905
Tavolo tondo 2 posti
2 seats round table



906
Tavolo tondo 2/4 posti
2/4 seats round table



907
Tavolo pieghevole 2/4 posti
2/4 seats folding table

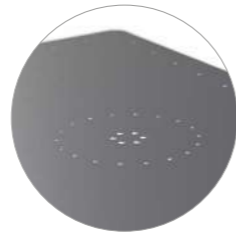

Fori decorativi per il deflusso dell'acqua.
Decorative holes for water drainage.

904
Tavolo pieghevole 5 posti
5 seats folding table



Gli archi conferiscono grazia alla struttura delle gambe e, fungendo da poggipiedi, garantiscono un maggior comfort in uso.
The inner arches make the legs elegant and, used as footstool, allow higher comfort in use.

903
Tavolo pieghevole
4/6 posti
4/6 seats folding table



PRODOTTI—PRODUCTS

Codice/Code Tipologia/Typology	Disegno/Drawing	Info
905 Tavolo tondo 2 posti 2 seats round table ø60 - H72 Kg 6,4		
906 Tavolo tondo 2/4 posti 2/4 seats round table ø80 - H72 Kg 9,6		
907 Tavolo pieghevole 2/4 posti 2/4 seats folding table W76 - D76 - H74 Kg 12,2		
904 Tavolo pieghevole 5 posti 5 seats folding table ø105 - H74 Kg 16,3		
903 Tavolo pieghevole 4/6 posti 4/6 seats folding table W118 - D76 - H74 Kg 16,5		

COLORI STRUTTURA—FRAME COLORS

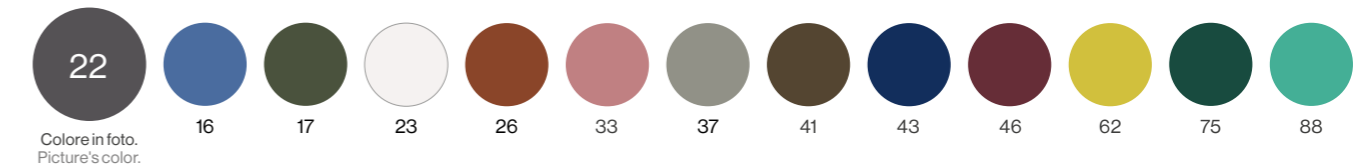

PLUS

- Tavolo pieghevole (x cod. 907, 904, 903): rimessaggio facile e salvaspazio.
Folding table (x cod. 907, 904, 903) for an easy and space-saving storage.
- Il bloccaggio delle gambe evita la chiusura accidentale e garantisce stabilità.
Legs locking prevents accidental closure and ensures stability.
- Design evergreen particolarmente adatto ad ambienti contract dallo stile classico, sia indoor che outdoor.
Evergreen design suitable to classic indoor and outdoor contract environments.



Scansiona e scopri i progetti.
Scan and discover the projects.

3484

Tavolo allungabile Balcony 4/6+2 posti
4/6+2 seats Balcony extensible table



La prolunga, riposta sotto il piano a scorrimento, permette di aggiungere 2 posti tavola.
The extension, that's placed under the rolling top, allows to add 2 seats.

3485

Tavolo allungabile 6+4 posti
6+4 seats extensible table



La prolunga è dotata di un meccanismo a farfalla e si estrae e posiziona facilmente.
The extension can be easily extracted and placed through a butterfly mechanism.

PRODOTTI—PRODUCTS



Codice/Code Tipologia/Typology	Disegno/Drawing	Info
-----------------------------------	-----------------	------

3484

Tavolo allungabile Balcony
4/6+2 posti
4/6+2 seats Balcony
extensible table

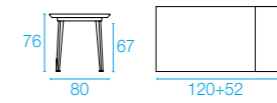

W120+52 - D80 - H76 Kg 40,6

3485

Tavolo allungabile
6+4 posti
6+4 seats
extensible table

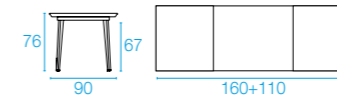

W160+110 - D90 - H76 Kg 76

COLORI STRUTTURA X COD. 3484—FRAME COLORS X COD. 3484

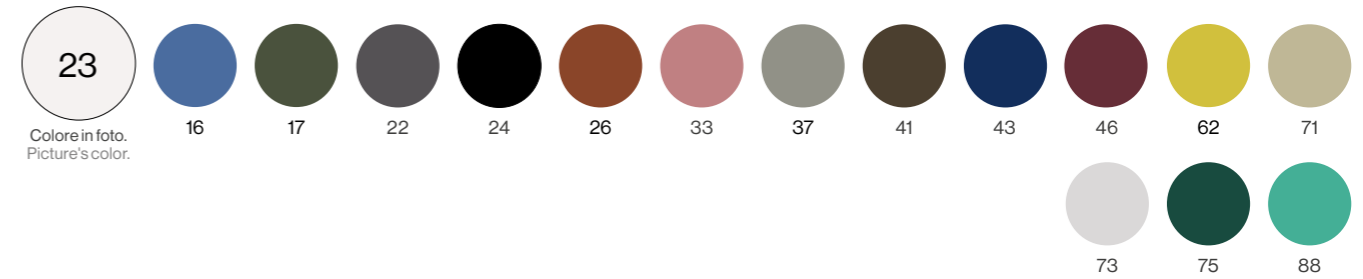

COLORI STRUTTURA X COD. 3485—FRAME COLORS X COD. 3485

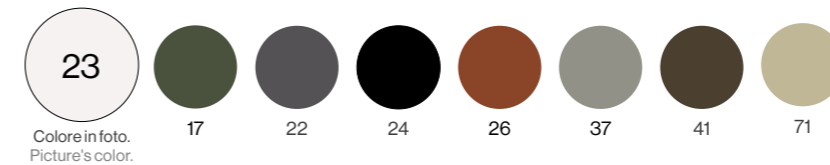



Scansiona e scopri i progetti.
Scan and discover the projects.

3486 Tavolo allungabile 8+4 posti 8+4 seats extensible table



Gambe realizzate con un profilo in acciaio zincato a caldo, disegnato da EMU.
Hot-dip zincated profile leg designed by EMU.

3487 Tavolo allungabile Imperial 8+4 posti 8+4 seats Imperial extensible table



Il tavolo Imperial cod. 3487 possiede una larghezza di 110 cm che permette di avere maggiore spazio al centro per riporre bicchieri e vassoi.
Cod. 3487 imperial table is 110 cm wide allowing to add space in the middle for glasses and trays.

3488 Tavolo allungabile tondo 6+4 posti 6+4 seats round extensible table



Ampio spazio centrale di appoggio, grazie al generoso diametro. Grande funzionalità, grazie alla forma tondeggiante del piano.

Large central space, thanks to the generous diameter. Great functionality, thanks to the rounded shape of the top.

PRODOTTI—PRODUCTS



Codice/Code Tipologia/Typology	Disegno/Drawing	Info
-----------------------------------	-----------------	------

3486 Tavolo allungabile 8+4 posti 8+4 seats extensible table

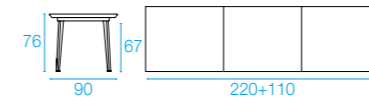

W220+110 - D90 - H76 Kg 80

3487 Tavolo allungabile Imperial 8+4 posti 8+4 seats Imperial extensible table

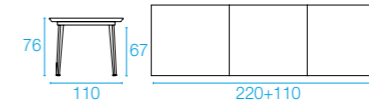

W220+110 - D110 - H76 Kg 88,2

3488 Tavolo allungabile tondo 6+4 posti 6+4 seats round extensible table

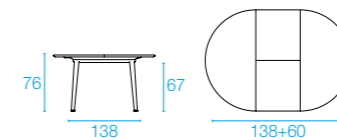

W138+60 - D138 - H76 Kg 59,0

COLORI STRUTTURA X COD. 3488—FRAME COLORS X COD. 3488

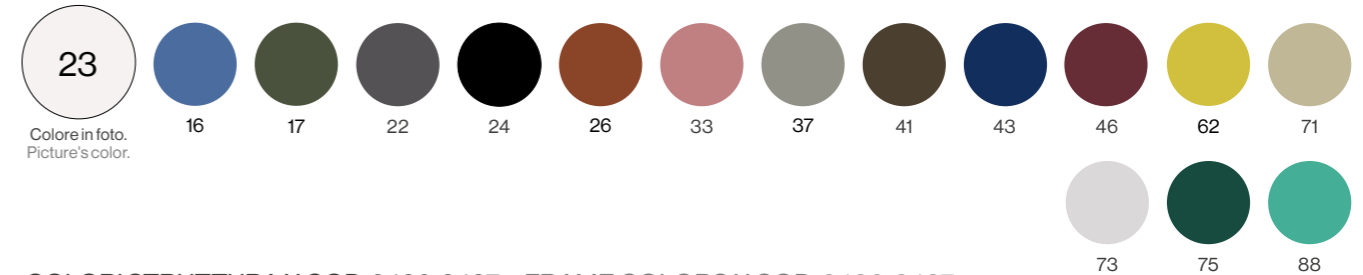

COLORI STRUTTURA X COD. 3486, 3487—FRAME COLORS X COD. 3486, 3487

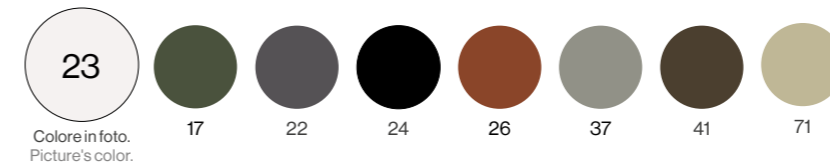

PLUS

• Bordo del piano realizzato in lamiera zincata a caldo e piegata per dettagli essenziali e puliti.
Bended top edge in hot-dip zincated sheet for neat details.

• Design lineare e trasversale alle varie collezioni di sedute multimateriale.
Essential design suitable for several multimaterial seats.

• Piano pieno in lamiera prezinata a caldo che permette un'agevole pulizia grazie alla planarità del piano stesso.
Hot-dip zincated sheet top that, as an even surface, allows an easy cleaning.

• Questi tavoli si aprono agevolmente facendo scorrere lateralmente il piano ed estraendo la prolunga interna.
These tables can be easily opened rolling sideways the top and getting out the extension under placed.

• Il tavolo cod. 3485 e cod. 3488 può ospitare 6+4 posti tavola, cod. 3486 e cod. 3487 8+4 posti tavola.
Cod. 3485 table and cod. 3488 can have 6+4 seats, cod. 3486 and cod. 3487 8+4 seats.

• L'ampiezza di questa collezione di tavoli li rende trasversali e combinabili, nelle sue varianti, a tutte le sedute EMU.—The breadth of this table collection makes them transversal and matching, in their variants, with all EMU seats.



Scansiona e scopri i progetti.
Scan and discover the projects.

1038
Tavolo quadrato 8 posti
8 seats square table



Possibilità di ospitare comodamente 8 posti tavola, grazie alle gambe poste alle estremità che massimizzano la superficie utile del piano.
Possibility of comfortably accommodating 8 table seats, thanks to the legs placed at the ends which maximize the useful surface of the top.



Incavo centrale che permette di inserire l'inserto disponibile in tre diverse finiture: lamiera stirata, gres e teak.
Central cavity that allows installing the insert available in three different finishes: expanded metal sheet, porcelain stoneware and teak.

PRODOTTI—PRODUCTS



Codice/Code Tipologia/Typology	Disegno/Drawing	Info
1038 Tavolo quadrato 8 posti 8 seats square table W141 - D141 - H76 Kg 62,8		
1039 Inserto in gres porcellanato Porcelain stoneware central piece W46 - D46 - H0,6 Kg 2,8		
1040 Inserto in teak Teak central piece W46 - D46 - H3 Kg 3,0		
1041 Inserto in lamiera stirata Expanded metal sheet central piece W46 - D46 - H1,5 Kg 1,3		

COLORI STRUTTURA X COD. 1038, 1041—FRAME COLORS X COD. 1038, 1041

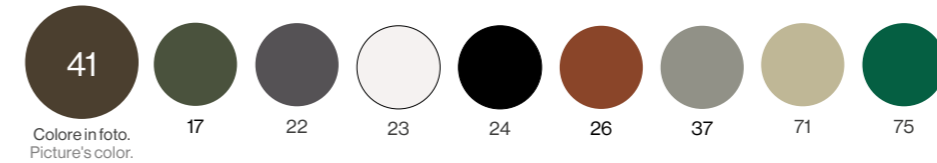

COLORI STRUTTURA X COD. 1039—FRAME COLORS X COD. 1039

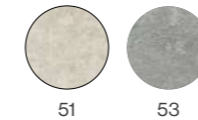

COLORI STRUTTURA X COD. 1040—FRAME COLORS X COD. 1040

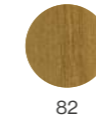

PLUS

- La struttura è composta da gambe e piano in lamiera piena, entrambi zincati a caldo.
The legs and top are both made of pre hot-dip zincated metal sheet.
- Lavorazioni laser e saldature MIG per una miglior precisione e pulizia estetica.
Laser processing and MIG welding for better precision and aesthetic cleanliness.
- Spazio centrale come piano di appoggio ampio, molto funzionale in uso.
Large and very functional in use central space.
- Grande stabilità data dalle gambe a sezione quadrata.
Great stability thanks to by the square profile of the legs.
- L'inserto decorativo, di dimensioni 46x46 cm, è sostituibile e disponibile in tre materiali: lamiera stirata prezincata a caldo, disponibile negli stessi colori di struttura; gres, disponibile in due colori; teak in doghe FSC® per un piacevole effetto tattile e visivo. The decorative insert, 46x46 cm in size, is replaceable and available in three materials: pre hot-dip zincated expanded metal sheet, available in the same colors as the frame; porcelain stoneware, available in two colours; FSC® teak slats for a pleasant touch, look and feel.
- Versatilità e abbinabilità ad una grande varietà di sedute.
Versatility and possibility to match with a large variety of seats.
- Imballo salvaspazio.—Flat pack.

ROUND

Design by Christophe Pillet



Scansiona e scopri i progetti.
Scan and discover the projects.

479

Tavolo allungabile 6+4 posti
con piano in lamiera
6+4 seats extensible table
with steel sheet top



Profilo lineare della gamba in acciaio.
Refined profile of steel legs.

480

Tavolo allungabile 6+4 posti
con piano in HPL
6+4 seats extensible table
with HPL top

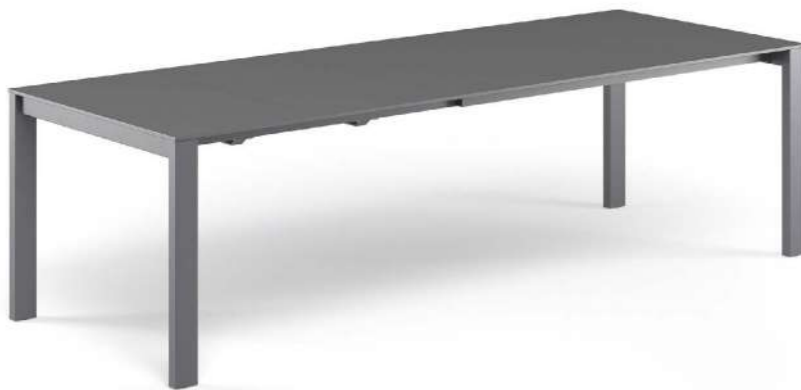

Piano in HPL.
HPL top.

PRODOTTI—PRODUCTS



Codice/Code Tipologia/Typology	Disegno/Drawing	Info	TEST
-----------------------------------	-----------------	------	------

479

Tavolo allungabile 6+4 posti
con piano in lamiera
6+4 seats extensible table
with steel sheet top
W160+54+54 - D100 - H75
Kg 76

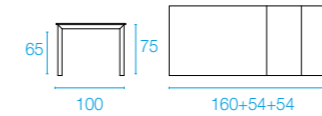

EN581-1/ EN581-3

480

Tavolo allungabile 6+4 posti
con piano in HPL
6+4 seats extensible table
with HPL top
W160+54+54 - D100 - H75
Kg 89

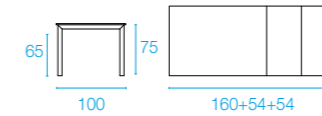

COLORI STRUTTURA X COD. 479—FRAME COLORS X COD. 479

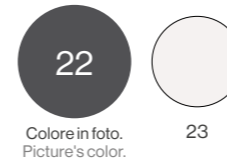

22
Colore in foto.
Picture's color.

23

COLORI STRUTTURA/PIANO IN HPL X COD. 480—FRAME/HPL TOP COLORS X COD. 480

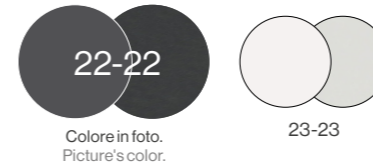

22-22
Colore in foto.
Picture's color.

23-23

PLUS

• Design lineare e trasversale alle varie collezioni di sedute multimateriale.

Essential design suitable for several multimaterial seat collections.

• I tavoli di questa collezione possono ospitare 6+4 posti tavola.

The tables of this collection can have 6+4 seats.

• Le prolunghe permettono di aggiungere 2 o 4 posti tavola.

The extensions allow to add 2 or 4 seats.

• Piano pieno in lamiera zincata a caldo che permette un'agevole pulizia grazie alla planarità del piano stesso.— Hot-dip zincated sheet top for an easy cleaning thanks to the even surface.

• Le gambe sono posizionate alle estremità angolari del tavolo così da massimizzare lo spazio fruibile, del piano stesso e a terra.

Legs are placed at the edge of angles to optimize the usable space under the top but also on the floor.



Scansiona e scopri i progetti.
Scan and discover the projects.

251
Tavolo rettangolare 8 posti
8 seats rectangular table



296
Tavolo allungabile 8+2/4 posti
8+2/4 seats extensible table



Doghe in teak FSC® per un piacevole effetto tattile e visivo.
FSC® teak slats for a pleasant touch, look and feel.

299
Tavolo rettangolare 6 posti
6 seats rectangular table



PRODOTTI—PRODUCTS



Codice/Code Tipologia/Typology	Disegno/Drawing	Info	TEST
251 Tavolo rettangolare 8 posti 8 seats rectangular table W225 - D100 - H75 Kg 31,2			EN581-1 / EN581-3
296 Tavolo allungabile 8+2/4 posti 8+2/4 seats extensible table W180+56+56 - D100 - H74 Kg 55,9			EN581-1 / EN581-3
299 Tavolo rettangolare 6 posti 6 seats rectangular table W166 - D100 - H74 Kg 23,3			EN581-1 / EN581-3

COLORI STRUTTURA/PIANO—FRAME/TOP COLORS



PLUS

- Design essenziale e trasversale ad altre sedute multimateriale.
Essential design suitable for several multimaterial seat collections.
- Struttura in profilati di alluminio verniciato che conferisce originalità al prodotto in combinazione con il piano in teak.— Coated aluminium profiles combined with teak that gives an original touch to the product.
- Il tavolo cod. 299 può ospitare 6 posti tavola, il tavolo cod. 251 può ospitare 8 posti tavola.
Table cod.299 can have 6 seats, cod. 251 8 seats.
- Il tavolo cod. 296 può ospitare 8+2/4 posti tavola, grazie all'aggiunta delle prolunghe rimesse inferiormente al piano del tavolo.
Table cod.296 can have 8+2 or 4 seats, thanks to the additional extensions placed under the top.



Scansiona e scopri i progetti.
Scan and discover the projects.



PRODOTTI—PRODUCTS

305
Tavolo quadrato 2 posti
2 seats square table



305
Tavolo quadrato 2 posti
2 seats square table
W70 - D70 - H75
Kg 17,5

306
Tavolo quadrato 4 posti
4 seats square table



La forma simil-ellittica del tubo delle gambe e l'orientamento a 45° circa rispetto ai due lati del piano conferisce particolare solidità al tavolo.
The elliptical shape of the leg pipe and the orientation at about 45° with respect to the two sides of the table top gives solidity to the table.

306
Tavolo quadrato 4 posti
4 seats square table
W90 - D90 - H75
Kg 23,0

307
Tavolo rettangolare 6 posti
6 seats rectangular table



307
Tavolo rettangolare
6 posti
6 seats rectangular table
W160 - D90 - H75
Kg 34,5

COLORI STRUTTURA—FRAME COLORS

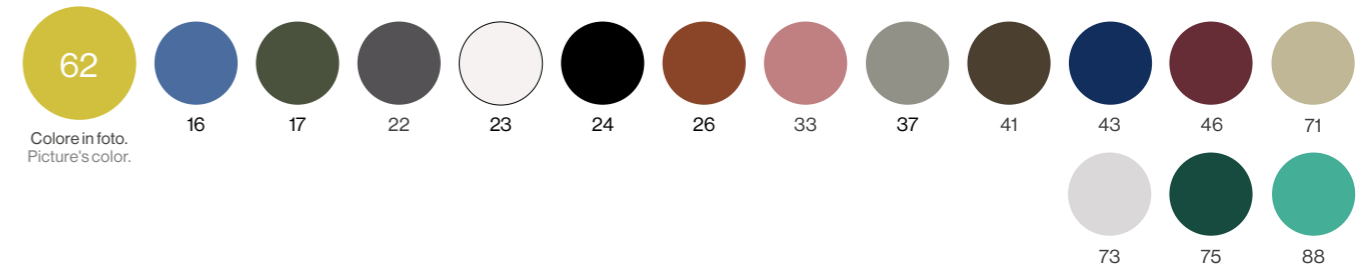

PLUS

- Piano pieno in lamiera zincata a caldo che permette un'agevole pulizia grazie alla planarità del piano stesso.—Hot-dip zincated sheet top for an easy cleaning thanks to the even surface.
- Le gambe, poste alle estremità angolari, lasciano ai lati la massima superficie fruibile e uno spazio sotto al tavolo per riporre le sedute quando non in uso.

Legs are placed at the edge of angles to optimize the usable space under the top but also on the floor.

- Gambe smontabili. Imballo salvaspazio.— Assemblable legs. Flat pack.

- Cod. 306 e 307 possono essere accostati per aumentare i posti tavola.

Cod. 306 and 307 can be placed side by side to increase the number of available seats.



Scansiona e scopri i progetti.
Scan and discover the projects.

725

Tavolo rettangolare 8 posti con piano in gres
8 seats rectangular table with gres top



Cod.725: bordo perimetrale in alluminio che incornicia e impreziosisce il piano in gres porcellanato.
Cod.725: perimeter aluminium profile that frames and enriches the porcelain stoneware top.

738

Tavolo rettangolare 8 posti
8 seats rectangular table



Giunti angolari in pressofusione di alluminio per un design esclusivo.
Die-casted aluminium angular connection for an exclusive design.

739

Tavolo allungabile 8+2/4 posti
8+2/4 seats extensible table



PRODOTTI—PRODUCTS



Codice/Code Tipologia/Typology	Disegno/Drawing	Info	TEST
-----------------------------------	-----------------	------	------

725

Tavolo rettangolare 8 posti con piano in gres
8 seats rectangular table with gres top
W203 - D103 - H74
Kg 50

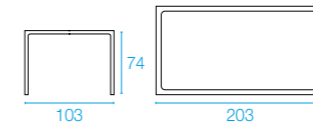

738

Tavolo rettangolare 8 posti
8 seats rectangular table
W203 - D103 - H74
Kg 30,4

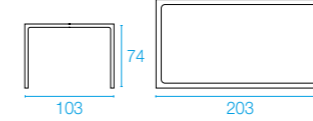

EN581-1 / EN581-3

739

Tavolo allungabile 8+2/4 posti
8+2/4 seats extensible table
W181+50+50 - D103 - H74
Kg 57

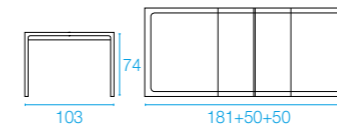

COLORI STRUTTURA/PIANO X COD. 725—FRAME/TOP COLORS X COD. 725

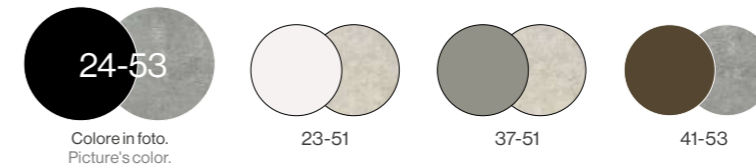

COLORI STRUTTURA X COD. 738, 739—FRAME COLORS X COD. 738, 739

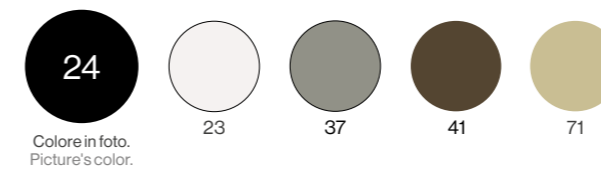

PLUS

- Gambe in acciaio prezinco a caldo.—Pre hot-dip zincated legs.
- I tavoli cod. 725, 738 e 724 possono ospitare 8 posti tavola, il tavolo cod.739 8+2/4 posti tavola, il tavolo cod. 720 4 posti tavola.
Cod. 725, cod. 738 and cod. 724 tables can have 8 seats, cod.739 8+2/4 seats, cod. 720 4 seats.
- Ampio spazio centrale come piano di appoggio, molto funzionale in uso.
Large and functional central space.
- Versatilità e abbinabilità ad una grande varietà di sedute.
Versatility and possibility to match with a large variety of seats.



Scansiona e scopri i progetti.
Scan and discover the projects.

720

Tavolo quadrato 4 posti con piano in gres
4 seats square table
with porcelain stoneware top



Piano in gres porcellanato colore 53 Piombo.
Porcelain stoneware top color 53 Lead.

724

Tavolo quadrato 8 posti con piano in gres
8 seats square table
with porcelain stoneware top



Piano in gres porcellanato colore 51 Sale.
Porcelain stoneware top color 53 Salt.

PRODOTTI—PRODUCTS



Codice/Code Tipologia/Typology	Disegno/Drawing	Info
-----------------------------------	-----------------	------

720

Tavolo quadrato 4 posti con piano in gres
4 seats square table
with porcelain stoneware top
W103 - D103 - H74
Kg 28,5

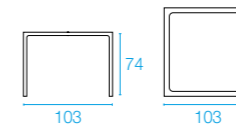

738

Tavolo quadrato 8 posti con piano in gres
8 seats square table
with porcelain stoneware top
W150 - D150 - H74
Kg 48,8

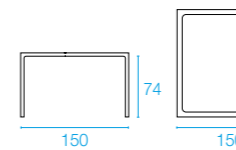

COLORI STRUTTURA/PIANO—FRAME/TOP COLORS

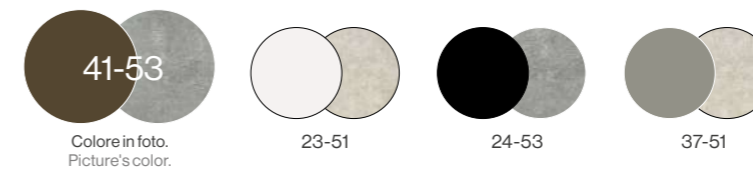

Colore in foto.
Picture's color.

23-51

24-53

37-51



23-51

Colore in foto.
Picture's color.



Scansiona e scopri i progetti.
Scan and discover the projects.

6061
Tavolo quadrato
4 posti
4 seats square table



Doghe in FSC® massello per un piacevole effetto tattile e visivo.
Solid FSC® teak slats for a pleasant touch, look and feel.

6062
Tavolo rettangolare
6/8 posti
6/8 seats
rectangular table



Il bordo perimetrale che incornicia finemente le doghe del piano ne definisce il design ricercato. Questi tavoli mantengono così il raccordo con gli altri elementi della collezione Twins, pur potendo essere trasversalmente combinati ad altre collezioni di sedute dining multimateriale.
Perimeter profile finely frames top slats and defines its elegant design. These tables keep consistency to other Twins elements but can also be combined to other multimaterial dining seat collections.

6063
Tavolo rettangolare
8/10 posti
8/10 seats
rectangular table



PRODOTTI—PRODUCTS



Codice/Code Tipologia/Typology	Disegno/Drawing	Info
6061 Tavolo quadrato 4 posti 4 seats square table W105 - D105 - H76 Kg 22,3		
6062 Tavolo rettangolare 6/8 posti 6/8 seats rectangular table W183 - D105 - H76 Kg 37,3		
6063 Tavolo rettangolare 8/10 posti 8/10 seats rectangular table W246 - D105 - H76 Kg 49,2		

COLORI STRUTTURA—FRAME COLORS

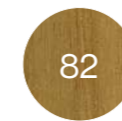

82
Colore in foto.
Picture's color.

PLUS

- Il teak è di qualità A, certificato FSC® e, quindi, gestito responsabilmente.
The teak quality degree is A and FSC® certified, so responsibly managed.
- Viti di fissaggio in acciaio inossidabile, a scomparsa, per un design ricercato.
Stainless steel hidden screws for elegant design.
- Adatti per utilizzo in ambienti marini e su imbarcazioni.— Suitable to marine environments and boats.
- Piedini regolabili.— Adjustable feet.
- Il tavolo quadrato cod. 6061 può ospitare 4 posti tavola, il tavolo rettangolare cod. 6062 6 posti tavola, il tavolo rettangolare grande cod. 6063 può ospitare fino a 8/10 posti tavola.— Cod.6061 square table can place 4 seats, cod.6062 rectangular table 6 seats, cod.6063 big rectangular table up to 8/10 seats.
- Imballo salvaspazio. Le gambe sono assemblabili al piano del tavolo e, pertanto, facilmente sostituibili in caso di danneggiamento.— Flat pack. The legs are assemblable and easy to replace in case of damage.



Scansiona e scopri i progetti.
Scan and discover the projects.

096
Tavolo impilabile 2/4 posti
2/4 seats stackable table



090
Tavolo impilabile 4 posti
4 seats stackable table



Piano in lamiera piena particolarmente adatto a un utilizzo contract poiché protegge le gambe in caso di caduta di liquidi sulla sua superficie.
Sheet metal top particularly suitable to contract use since the liquids don't go through the surface.

091
Tavolo impilabile 4/6 posti
4/6 seats stackable table



PRODOTTI—PRODUCTS



Codice/Code Tipologia/Typology	Disegno/Drawing	Info	TEST
-----------------------------------	-----------------	------	------

096 Tavolo impilabile 2/4 posti 2 seats stackable table W80 - D80 - H75 Kg 8,5			EN581-1/EN581-3
--	--	--	-----------------

090 Tavolo impilabile 4 posti 4 seats stackable table W90 - D90 - H75 Kg 9,8			
--	--	--	--

091 Tavolo impilabile 4/6 posti 4/6 seats stackable table W120 - D80 - H75 Kg 11,8			
--	--	--	--

COLORI STRUTTURA—FRAME COLORS

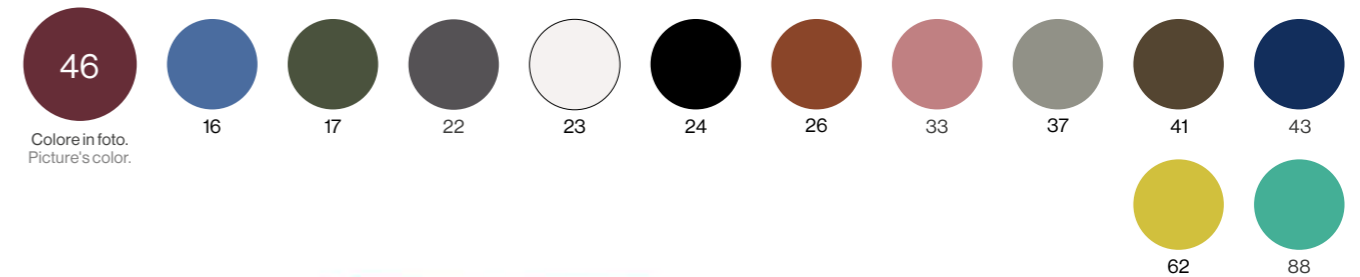

Impilabile.
Stackable.

PLUS

- Modello a 4 gambe dal design lineare e trasversale a tutte le collezioni.
4-legged model with a linear design, which can be combined with all collections.
- 4 piedi regolabili per garantire stabilità e un allineamento dei piani tra tavoli accoppiati.
4 adjustable feet to ensure stability and an even surface when tables are close.
- Autolivellante e dotato di piedini regolabili per compensare anche i dislivelli maggiori su pavimenti irregolari.
Adjustable feet of these self-leveling tables allow to compensate on uneven surfaces.
- Facile da montare. Imballo salvaspazio.— Easy to assemble. Flat pack.
- Tavoli leggeri grazie a piano e struttura in alluminio.— Light tables thanks to aluminium top and frame.
- Disponibili in diverse misure e idonei a tutti gli spazi.
Available in different sizes to make them suitable to all spaces.
- Imballati singolarmente.— Single pack.



Scansiona e scopri i progetti.
Scan and discover the projects.

505
Tavolo rettangolare 6 posti
6 seats rectangular table



Bordo degli angoli arrotondato.
Rounded edge corners.

536
Tavolo allungabile 6+4 posti
6+4 seats extensible table



538
Tavolo alto 6/8 posti
6/8 seats counter table



PRODOTTI—PRODUCTS



Codice/Code Tipologia/Typology	Disegno/Drawing	Info	TEST
505 Tavolo rettangolare 6 posti 6 seats rectangular table W160 - D97,5 - H74 Kg 19,4			EN581-1/ EN581-3
536 Tavolo allungabile 6+4 posti 6+4 seats extensible table W160+55+55 - D97,5 - H74 Kg 47,0			
538 Tavolo alto 6/8 posti 6/8 seats counter table W180 - D70 - H105 Kg 24,0			EN581-1/ EN581-3

COLORI STRUTTURA—FRAME COLORS

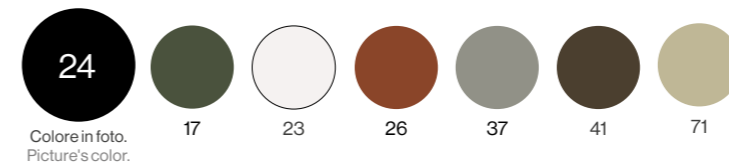

PLUS

- Design essenziale e trasversale a sedute multimateriale.
Essential design suitable for several multimaterial seat collections.
- Gambe smontabili. Imballo salvaspazio.— Removable legs. Flat pack.
- Il tavolo cod. 505 può ospitare 6 posti tavola, il tavolo cod. 536 6+2/4 posti tavola.
Cod.505 table can have 6 seats, cod.536 6+2/4 seats.

EMU NEL MONDO EMU IN THE WORLD

ROUND—TRULLO ERMES & ATENA—ITALY



RIO R50+NOVA—MAXXI MUSEUM—ITALY

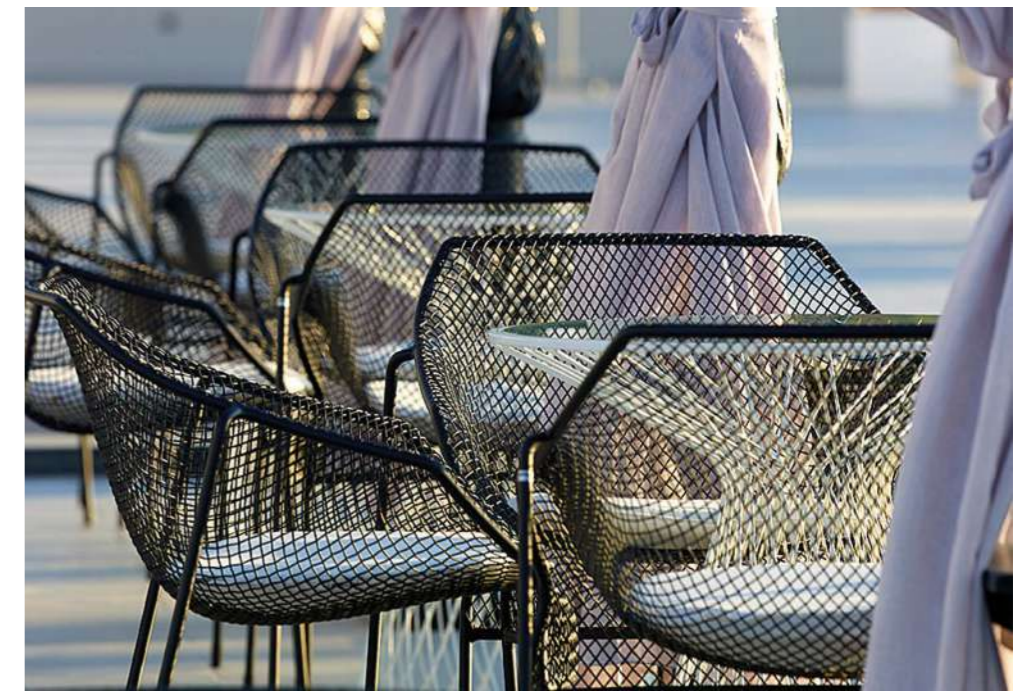

HEAVEN+RE-TROUVÉ—ANEMOS LUXURY GRAND RESORT—GREECE



TAVOLI A PALO CENTRALE CENTRAL POLE TABLES

Disponibili in dimensioni, materiali e colori differenti, i tavoli con struttura a palo centrale conferiscono all'ambiente un'estetica pulita ed elegante. Per una soluzione salvaspazio, questa tipologia di tavolo prevede piani abbattibili. I pali centrali, con sezioni quadrate e rotonde, vengono abbinati con basamenti anch'essi disponibili in più forme e completati con un'ampia scelta di piani.

Available in different sizes, materials and colors, our tables with a central pole frame ensure the space a feeling of elegance and clean lines. This type of table also offers space-saving solutions with collapsible tops. The central pole with square and round sections is matched with round, square and cross-shaped bases, completed with a wide selection of table tops.

INDEX

LEGENDA—LEGEND
● Acciaio—Steel
● Alluminio—Aluminium
● Legno—Wood

192	COLLIER	●
194	COMO	●
196	DARWIN	●
202	GRACE	●
204	HEAVEN	●
206	HPL TOPS	●
208	RE-TROUVÉ	●
210	ROUND	●
214	SHINE	●
216	TABLE SYSTEM	●
218	TERRAMARE	●
220	THOR	●



Scansiona e scopri i progetti.
Scan and discover the projects.



1357+1342
Tavolo quadrato 4 posti
4 seats square table

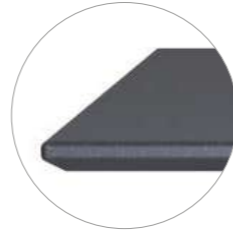

Piano in lamiera piena zincata a caldo con bordo piegato per un maggiore comfort di appoggio in uso.
Hot-dip zincated steel sheet top with folded edge for greater comfort in use.

1358+1344
Tavolo tondo 6/7 posti con piano in lamiera
6/7 seats round table with steel sheet top



Base circolare con sottopiedi regolabili per una maggiore stabilità e per adattarsi alle irregolarità del terreno.
Round base with adjustable feet for greater stability and to adapt to uneven floor.

1358+1345
Tavolo tondo 6/7 posti con piano in gres
6/7 seats round table with gres top

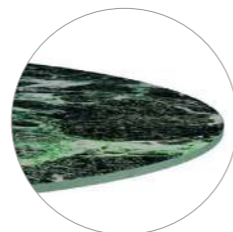

Finitura in gres porcellanato come alternativa materica di piano.
Porcelain stoneware for a textured top choice.

PRODOTTI—PRODUCTS

Codice/Code Tipologia/Typology	Disegno/Drawing	Info
-----------------------------------	-----------------	------

1357+1342
Tavolo quadrato 4 posti
4 seats square table
W90 - D90 - H74
Kg 27,6

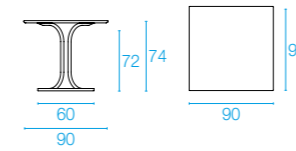

1358
Struttura tavolo tondo
Round table frame
x cod. 1344, 1345
ø90 - H72,5
Kg 22,2

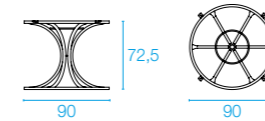

1344
Piano in lamiera per tavolo tondo 6/7 posti
6/7 seats steel sheet round table top
x cod. 1358
ø142 - H3
Kg 31,6

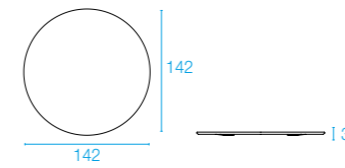

1345
Piano in gres per tavolo tondo 6/7 posti
6/7 seats gres round table top
x cod. 1358
ø150 - H1,2
Kg 50,6

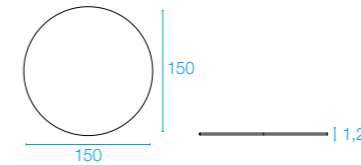

COLORI STRUTTURA X COD. 1357, 1342, 1358, 1344—FRAME COLORS X COD. 1357, 1342, 1358, 1344

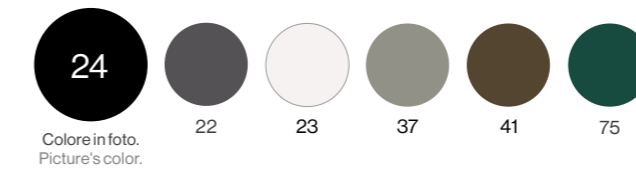

COLORI PIANO X COD. 1345—TOP COLORS X COD. 1345

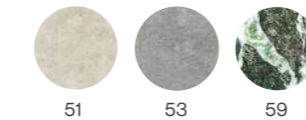

PLUS

- Possibilità di scelta tra piano in metallo e piano in gres.
Possibility to choose between metal top and stoneware top.
- I piani sono rinforzati con un tubolare che funge anche da unione alla struttura.
The tops are reinforced with a tubular which also acts as a connection to the frame.
- Viterie in acciaio inox.—Stainless steel screws.



Scansiona e scopri
i progetti.
Scan and discover
the projects.

494+1207
Tavolo tondo 6/7 posti
6/7 seats round table



Il sinuoso reticolo di tondini zincati della base del tavolo evoca forme classiche e definisce il design esclusivo del prodotto. La struttura in tondini è realizzata tramite saldatura a proiezione. The sinuous grid of zincated bars of the table base reminds classic shapes and defines the exclusive design of the collection. The bars frame is manufactured by spot welding.



Piano in lamiera zincata di ampie dimensioni capace di ospitare 7 posti tavola.
Large table top in hot-dip zincated sheet up to 7 seats.

PRODOTTI—PRODUCTS



Codice/Code Tipologia/Typology	Disegno/Drawing	Info
-----------------------------------	-----------------	------

494

Struttura tavolo tondo
Round table frame
ø110 - H74
Kg 13,2

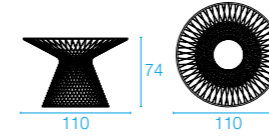

1207

Piano tavolo tondo
6/7 posti
6/7 seats round
table top
ø144 - H2
Kg 26,6



COLORI STRUTTURA—FRAME COLORS

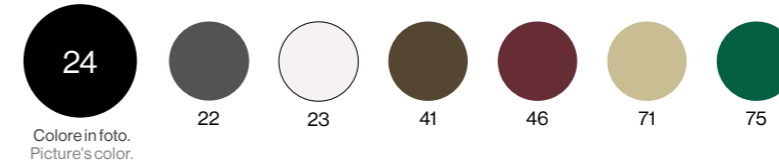

PLUS

- Piano pieno in lamiera prezincata a caldo che permette un'agevole pulizia grazie alla sua planarità.
Hot-dip zincated sheet top for an easy cleaning thanks to the even surface.
- Sapiente lavorazione del tondino d'acciaio che dona un design elegante e ricercato.
Skillful manufacturing of zincated bar that defines and elegant design.



Scansiona e scopri i progetti.
Scan and discover the projects.

525
Tavolo abbattibile 2 posti
2 seats collapsible table



528
Tavolo alto abbattibile 2 posti
2 seats collapsible counter table



529
Tavolo abbattibile 2/4 posti
2/4 seats collapsible table



PRODOTTI—PRODUCTS



Codice/Code Tipologia/Typology	Disegno/Drawing	Info	TEST
525 Tavolo abbattibile 2 posti 2 seats collapsible table W70 - D70 - H74 Kg 14,3			EN581-1 / EN581-3
528 Tavolo alto abbattibile 2 posti 2 seats collapsible counter table W70 - D70 - H105 Kg 15,2			EN581-1 / EN581-3
529 Tavolo abbattibile 2/4 posti 2/4 seats collapsible table W80 - D80 - H74 Kg 16,0			EN581-1 / EN581-3

COLORI STRUTTURA—FRAME COLORS

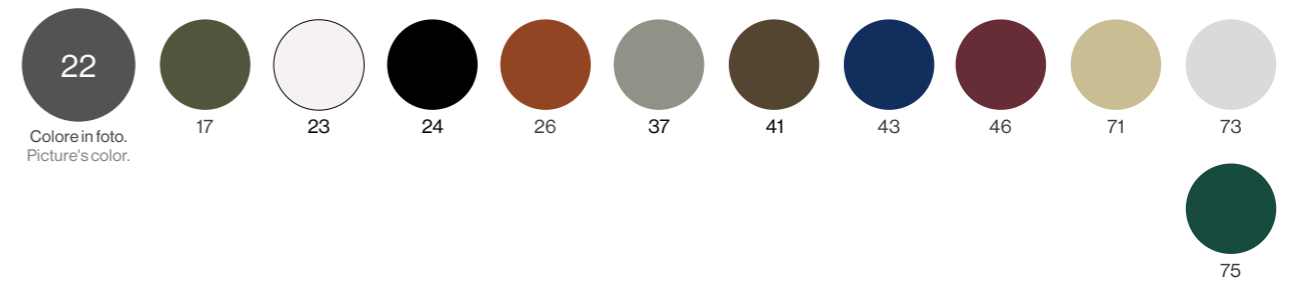

PLUS

- Piano pieno in lamiera zincata a caldo che permette un'agevole pulizia grazie alla planarità del piano stesso.— Hot-dip zinced sheet top for an easy cleaning thanks to the even surface.
- Base a crociera per un ridotto ingombro a terra per un maggiore spazio delle sedute sotto il tavolo. Cross base that reduces space on the floor for a greater space for seatings under the top.
- Varie dimensioni disponibili.— Available in different sizes.
- Piano abbattibile, per una soluzione salvaspazio, tramite snodo in pressofusione di alluminio. Reclining tops for a space-saving solution, thank to a die-cast aluminium joint.
- Sottopiede regolabile per una migliore stabilità su superfici irregolari. Adjustable feet for a higher stability on uneven surfaces.
- Struttura cod. 564: possibili personalizzazioni con piani HPL. Frame code 564: possible customizations with HPL table tops.



Scansiona e scopri i progetti.
Scan and discover the projects.

848
Tavolo abbattibile 2 posti
2 seats collapsible table



849
Tavolo abbattibile 2/4 posti
2/4 seats collapsible table



PRODOTTI—PRODUCTS



Codice/Code Tipologia/Typology	Disegno/Drawing	Info
-----------------------------------	-----------------	------

848
Tavolo abbattibile
2 posti
2 seats collapsible table
ø60 - H74
Kg 11,9

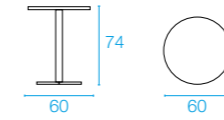

849
Tavolo abbattibile
2/4 posti
2/4 seats collapsible table
ø80 - H74
Kg 14,8

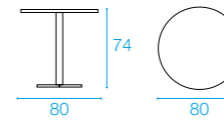

564
Struttura tavolo
per piani HPL
Table frame for HPL tops
x cod. 977, 978
W51 - D51 - H73
Kg 7,3

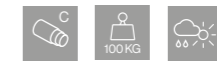
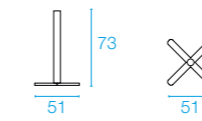

COLORI STRUTTURA—FRAME COLORS

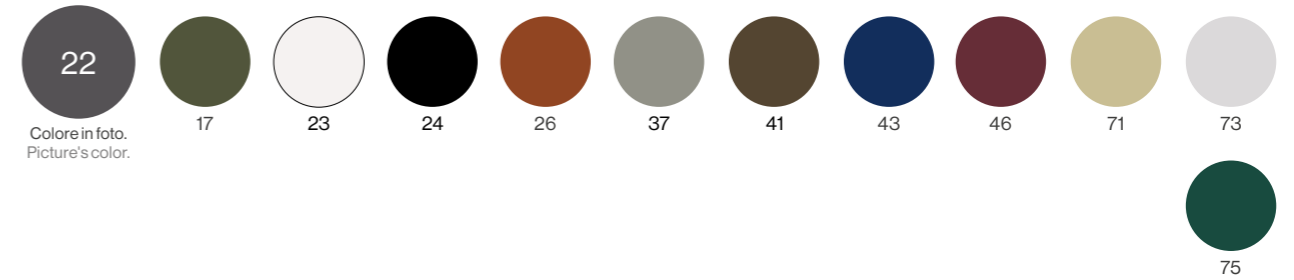



Scansiona e scopri i progetti.
Scan and discover the projects.



539
Tavolo alto tondo abbattibile 2 posti
2 seats collapsible round table



540
Tavolo alto tondo abbattibile 2/4 posti
2/4 seats collapsible round table



PRODOTTI—PRODUCTS

Codice/Code Tipologia/Typology	Disegno/Drawing	Info
-----------------------------------	-----------------	------

539
Tavolo alto tondo abbattibile 2 posti
2 seats collapsible round table
ø60 - H105
Kg 12,8

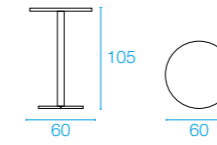

540
Tavolo alto tondo abbattibile 2/4 posti
2/4 seats collapsible round table
ø80 - H105
Kg 15,7

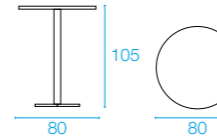

COLORI STRUTTURA—FRAME COLORS

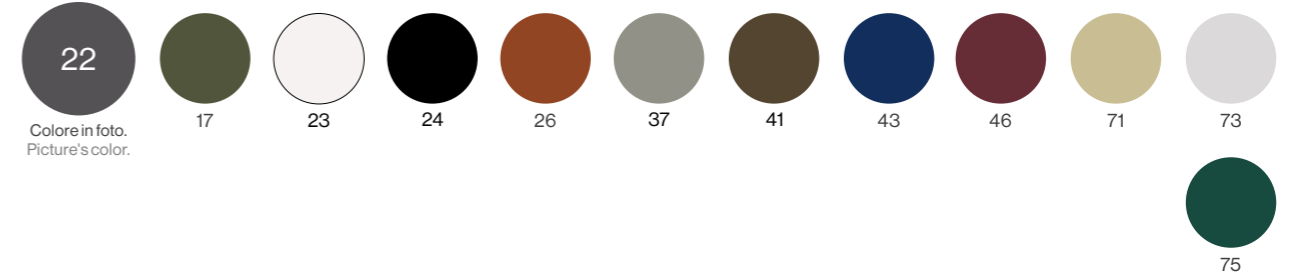



285+288
Tavolo abbattibile bordo quadro 2 posti
2 seats collapsible square edge table



Elegante struttura a palo centrale dalle forme slanciate. Gambe realizzate in tubolare di alluminio e giunto in pressofusione che conferisce un'estetica pulita e curata.
Central pole table with slender shapes. Legs made of aluminium tubular with die-cast joint give a clean and refined aesthetic.

285+286
Tavolo abbattibile bordo quadro 2/4 posti
2/4 seats collapsible square edge table



N.4 sottopiedi regolabili che permettono di livellare il tavolo e garantire stabilità anche su superfici irregolari.
N. 4 adjustable feet that allow the table to be levelled and ensure its stability even on uneven floors.

PRODOTTI—PRODUCTS



Codice/Code Tipologia/Typology	Disegno/Drawing	Info	TEST
285 Struttura tavolo abbattibile Collapsible table frame x cod. 286, 288 W52 - D52 - H70 Kg 3,3			EN581-1 / EN581-3 (cod. 285+288, 285+286)
288 Piano bordo quadro per tavolo abbattibile 2 posti 2 seats collapsible square edge table top W70 - D70 - H3,5 Kg 8,6			EN581-1 / EN581-3 (cod. 285+288)
286 Piano bordo quadro per tavolo abbattibile 2/4 posti 2/4 seats collapsible square edge table top W80 - D80 - H3,5 Kg 9,2			EN581-1 / EN581-3 (cod. 285+286)

COLORI STRUTTURA—FRAME COLORS

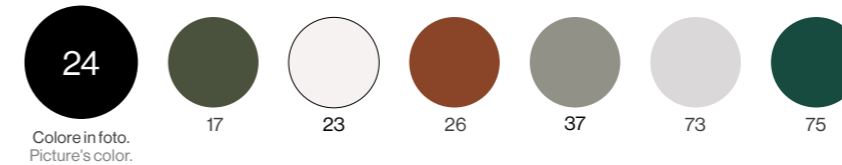

PLUS

- Piano reclinabile.—Reclining top.
- In fase di rimessaggio, abbattendo i piani ed incrociando le varie basi, si può ottenere un "impilamento verticale" salvaspazio.—For storage, tops can be reclined and bases crossed so tables can be vertically stacked in a space saving solution.
- Viteria in acciaio inossidabile per ridurre il rischio di corrosione, ruggine e deterioramento da agenti atmosferici.—Stainless steel screws to reduce the risk of corrosion, rust and deterioration due to weather conditions.
- Possibilità di combinare due diverse tipologie di piani, uno con bordo squadrato e una con bordo arrotondato da scegliere a seconda dello stile della seduta in abbinamento.
It is possible to combine two different types of tops, one with a square edge and one with a round edge according to the style of the matching seat.
- Tavoli leggeri grazie a piano e struttura in alluminio.—Light tables thanks to aluminium top and frame.



Scansiona e scopri i progetti.
Scan and discover the projects.

493+493/V
Tavolo tondo 2/4 posti
2/4 seats round table



494+494/V
Tavolo tondo 4/6 posti
4/6 seats round table



Piano in cristallo temperato, sicuro in uso, capace di ospitare 6 posti tavola.
Safe in use tempered glass table top, up to 6 seats.

PRODOTTI—PRODUCTS



Codice/Code Tipologia/Typology	Disegno/Drawing	Info
-----------------------------------	-----------------	------

493

Struttura tavolo tondo
Round table frame
x cod. 493/V
ø70 - H74
Kg 8,7

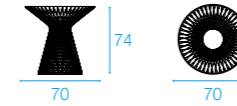

494

Struttura tavolo tondo
Round table frame
x cod. 494/V
ø110 - H74
Kg 14,6

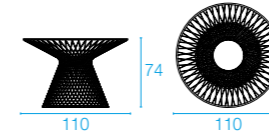

COLORI STRUTTURA X COD. 493—FRAME COLORS X COD. 493

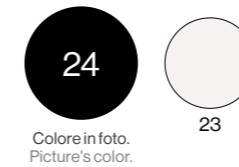

COLORI STRUTTURA X COD. 494—FRAME COLORS X COD. 494

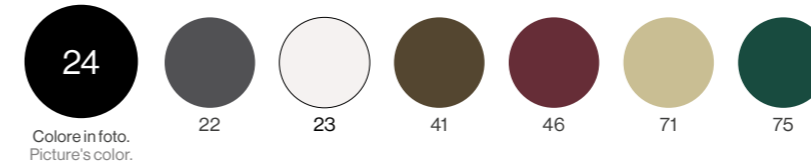

PIANI IN CRISTALLO—GLASS TOPS

Codice/Code Tipologia/Typology	Colori Colors
493/V Piano in cristallo per tavolo 2/4 posti Glass top for 2/4 seats table x cod. 493 ø80 - H0,6 Kg 7,5	00 83
494/V Piano in cristallo per tavolo 4/6 posti Glass top for 4/6 seats table x cod. 494 ø120 - H0,8 Kg 22,5	00 83

HPL TOPS

Design by EMU D&S Lab



Scansiona e scopri i progetti.
Scan and discover the projects.

464+977

Tavolo 2 posti con piano in HPL
2 seats table with HPL top



22 Grigio—Grey



564+977

Tavolo 2 posti con piano in HPL
2 seats table with HPL top



54 Marrone vintage
Vintage brown



464+978

Tavolo 2/4 posti con piano in HPL
2/4 seats table with HPL top



23 Bianco—White



564+978

Tavolo 2/4 posti con piano in HPL
2/4 seats table with HPL top



73 Cemento—Cement



206

PRODOTTI—PRODUCTS



Codice/Code Tipologia/Typology	Disegno/Drawing	Info
464 Struttura tavolo per piani HPL Table frame for HPL tops x cod. 977, 978 W45 - D45 - H73 Kg 14,0		
564 Struttura tavolo per piani HPL Table frame for HPL tops x cod. 977, 978 W51 - D51 - H73 Kg 7,3		
1117 Struttura tavolo grande per piani HPL Big table frame for HPL tops x cod. 979 W73 - D73 - H73 Kg 12,0		
977 Piano in HPL per tavolo 2 posti HPL top for 2 seats table x cod. 464, 564 W69 - D69 - H1 Kg 8,3		
978 Piano in HPL per tavolo 2/4 posti HPL top for 2/4 seats table x cod. 464, 564 W79 - D79 - H1 Kg 10,5		
979 Piano in HPL per tavolo 4 posti HPL top for 4 seats table x cod. 1117 W89 - D89 - H1 Kg 13,3		

COLORI STRUTTURA COD. 464, 564, 1117—FRAME COLORS COD. 464, 564, 1117

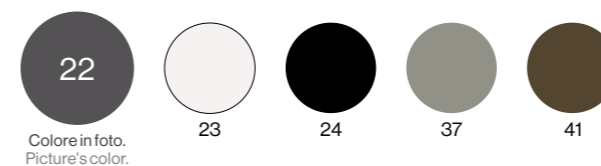

COLORI PIANI HPL COD. 977, 978, 979—HPL TOPS COLORS COD. 977, 978, 979



PLUS

- Utilizzabile con le basi delle collezioni Round, Darwin e Table System.
Suitable to the bases of Round, Darwin and Table System collections.
- L'HPL è un materiale composito di strati di carta kraft e carta decorativa impregnati di resine polimeriche pressati ad alte temperature, con importanti proprietà meccaniche.
HPL is a composite material of layers of kraft paper and decorative paper impregnated with polymer resins pressed at high temperatures, with important mechanical properties.
- 6 differenti versioni tra colori pieni e colori che simulano i materiali del legno e del cemento.
6 different versions between plain colors and colors that simulate the wood and cement's materials.
- Pregi HPL: oltre ai particolari effetti "naturali", i piani HPL sono resistenti ai graffi, urti, usura, vapore, calore, macchie e luce.— In addition to the special natural effects, HPL surfaces are resistant to scratches, shocks, wear, steam, heat, stains and light.
- Superficie del piano che permette un'agevole pulizia grazie alla sua planarità.
Easy cleaning thanks to the even top surface.

207

RE-TROUVÉ

Design by Patricia Urquiola



Scansiona e scopri i progetti.
Scan and discover the projects.

569B+569P
Tavolo tondo 5 posti
5 seats round table



Tondino di acciaio zincato piegato con macchine a controllo numerico che dà vita ad un motivo estetico originale, esclusivo ed iconico.
Hot-dip zincated steel bar bent with numerical control machines that creates an original, exclusive and iconic aesthetic pattern.

570B+570P
Tavolo tondo 6 posti
6 seats round table



Piano in lamiera prezincata a caldo di ampie dimensioni capace di ospitare 6 posti tavola.
Pre hot-dip zincated sheet.
Large table top up to 6 seating.

PRODOTTI—PRODUCTS

Codice/Code Tipologia/Typology	Disegno/Drawing	Info
-----------------------------------	-----------------	------

569B+569P
Tavolo tondo 5 posti
5 seats round table
ø105 - H74
Kg 22,2

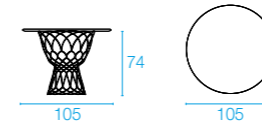

570B+570P
Tavolo tondo 6 posti
6 seats round table
ø130 - H74
Kg 29,2

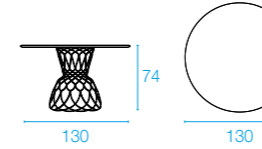

COLORI STRUTTURA—FRAME COLORS

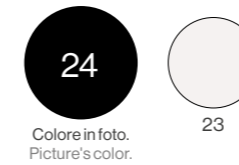

24
Colore in foto.
Picture's color.

23

PLUS

- Tavoli con piano in lamiera zincata a caldo, disponibili in diverse dimensioni.
Tables with hot-dip zincated sheet top, available in different sizes.
- Struttura saldata a proiezione, cataforizzata in un unico pezzo che offre un'alta resistenza agli agenti atmosferici anche nei punti di giuntura.—Spot welded frame, that is cataphorised in a single piece, increasing the resistance to weather conditions even on the most critical points.
- Sottopiedi in nylon trasparente per maggiore stabilità su suolo irregolare; elemento comune a sedute, tavoli e vasi.
Transparent nylon feet for a higher stability on irregular floor; common element to seats, tables and vases.

ROUND

Design by Christophe Pillet



Scansiona e scopri i progetti.
Scan and discover the projects.

472
Tavolo quadrato 2 posti
2 seats square table



471
Tavolo quadrato 2 posti
2 seats square table



Piano in lamiera piena zincata a caldo particolarmente adatto ad un utilizzo contract poiché protegge le gambe in caso di caduta di liquidi sulla sua superficie.
Hot-dip zinced sheet top particularly suitable to contract use since the liquids don't go through the surface.

473
Tavolo quadrato 2/4 posti
2/4 seats square table



PRODOTTI—PRODUCTS



Codice/Code Tipologia/Typology	Disegno/Drawing	Info	TEST
472 Tavolo quadrato 2 posti 2 seats square table W60 - D60 - H75 Kg 20,0			
471 Tavolo quadrato 2 posti 2 seats square table W70 - D70 - H75 Kg 22,0			
473 Tavolo quadrato 2/4 posti 2/4 seats square table W80 - D80 - H75 Kg 27,2			EN581-1 / EN581-3

COLORI STRUTTURA—FRAME COLORS

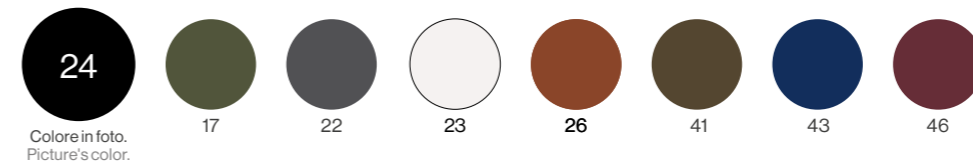

PLUS

• Ampia offerta di misure per renderli idonei a tutti gli spazi.
Tables available in different sizes to make them suitable to all spaces.

ROUND

Design by Christophe Pillet



Scansiona e scopri i progetti.
Scan and discover the projects.

470
Tavolo tondo 4 posti
4 seats round table



474B+474P
Tavolo rettangolare 4 posti
4 seats rectangular table



475
Tavolo alto 2 posti
2 seats counter table



476
Tavolo rettangolare 2 posti
2 seats rectangular table



Sottopiedi regolabili per una migliore stabilità su superfici irregolari.
Adjustable feet for a higher stability on uneven surfaces.

PRODOTTI—PRODUCTS



Codice/Code Tipologia/Typology	Disegno/Drawing	Info	TEST
470 Tavolo tondo 4 posti 4 seats round table ø90 - H75 Kg 23,0			
474B+474P Tavolo rettangolare 4 posti 4 seats rectangular table W120 - D80 - H75 Kg 41,8			
475 Tavolo alto 2 posti 2 seats counter table W60 - D60 - H105 Kg 23,5			
476 Tavolo rettangolare 2 posti 2 seats rectangular table W70 - D50 - H75 Kg 20,1			EN581-1/EN581-3

COLORI STRUTTURA—FRAME COLORS

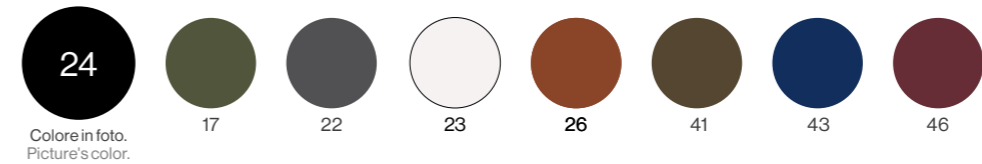



254+256
Tavolo 2/4 posti con piano in HPL
2/4 seats table with HPL top



Palo centrale con base a crociera per l'ottimizzazione dell'ingombro a terra delle sedute in uso.
Central pole with cross base to save space for seatings in use.

254+257
Tavolo 2/4 posti con piano in teak
2/4 seats table with teak top



Sottopiedi regolabili che permettono di livellare il tavolo e garantire stabilità anche su suoli più irregolari.
Adjustable feet to ensure table stability even on the most irregular floors.

255+258
Tavolo alto 2 posti con piano in HPL
2 seats counter table with HPL top



PRODOTTI—PRODUCTS



Codice/Code Tipologia/Typology	Disegno/Drawing	Info	TEST
254 Struttura tavolo Table frame x cod. 256, 257 W75 - D75 - H72 Kg 3,4			EN581-1/EN581-3 (cod. 254+257)
255 Struttura tavolo Table frame x cod. 258 W66 - D66 - H103 Kg 5,2			EN581-1/EN581-3 (cod. 255+258)
256 Piano in HPL per tavolo 2/4 posti HPL top for 2/4 seats table x cod. 254 W79 - D79 - H1,2 Kg 10,2			
257 Piano in teak per tavolo 2/4 posti Teak top for 2/4 seats table x cod. 254 W79 - D79 - H1,2 Kg 5,4			EN581-1/EN581-3 (cod. 254+257)
258 Piano in HPL per tavolo 2 posti HPL top for 2 seats table x cod. 255 W60 - D60 - H1,2 Kg 5,9			EN581-1/EN581-3 (cod. 255+258)

COLORI STRUTTURA E PIANO IN HPL X COD. 254, 255, 256, 258—FRAME AND HPL TOP COLORS X COD. 254, 255, 256, 258

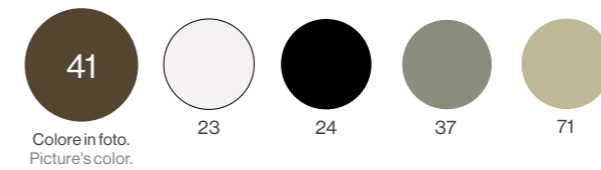

COLORI PIANO IN TEAK X COD. 257—TEAK TOP COLORS X COD. 257

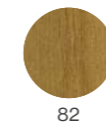

PLUS

- Struttura in tubolare di lega di alluminio.—Tubular aluminium alloy frame.
- Due opzioni per il piano: teak FSC® per un piacevole effetto tattile e visivo, HPL come pratica soluzione. Possibilità di personalizzazione con piano cliente.—Two options for the top: FSC® teak for a pleasant touch, look and feel and HPL as a handy solution. Possibility of customization with client's top.

TABLE SYSTEM

Design by EMU D&S Lab



Scansiona e scopri i progetti.
Scan and discover the projects.

1156

Tavolo bordo tondo 5/6 posti
5/6 seats round edge table

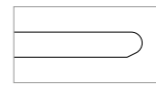

Piano bordo tondo—Round edge top

PRODOTTI—PRODUCTS

Codice/Code Tipologia/Typology	Disegno/Drawing	Info
1156 Tavolo bordo tondo 5/6 posti 5/6 seats round edge table ø117 - H74 Kg 25,0		

COLORI STRUTTURA—FRAME COLORS

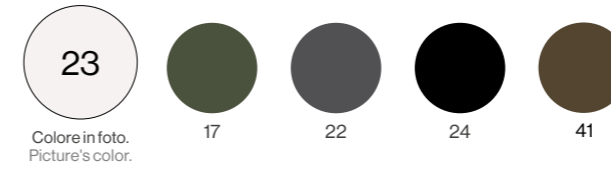



Scansiona e scopri i progetti.
Scan and discover the projects.



726
Tavolo smart
Smart table



Il palo centrale è regolabile e permette un'altezza minima di 44 cm e una massima di 65 cm. L'altezza può essere fissata tramite pratico sistema di bloccaggio.

The central pole can be adjusted and allows 44 cm as minimum height and 65 cm as maximum one. The height can be fixed thanks to a handy clamping system.

Codice/Code Tipologia/Typology	Disegno/Drawing	Info
-----------------------------------	-----------------	------

726

Tavolo smart
Smart table
W65 - D49 - H44/65
Kg 4,9

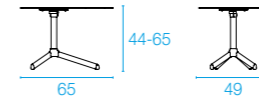

COLORI STRUTTURA—FRAME COLORS

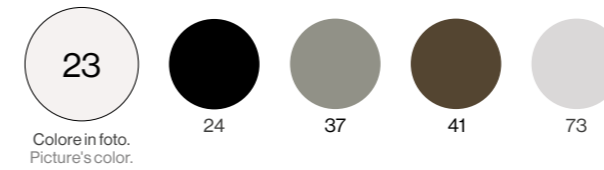

Colore in foto.
Picture's color.

PLUS

- Utile piano di appoggio per tutte le sedute sia per un utilizzo di smart working sia come tavolo di servizio per snack e aperitivi.— It's a helpful worktop matching with whatever seating, good for many uses like smart working or a side table for snacks and drinks.
- La base, realizzata a raggiera, ne permette l'utilizzo con tutte le sedute della nostra collezione. Its radial base allows matching it with all EMU seatings.



Scansiona e scopri i progetti.
Scan and discover the projects.

900
Tavolo tondo 2 posti
2 seats round table



902
Tavolo tondo 2/4 posti
2/4 seats round table



PRODOTTI—PRODUCTS



Codice/Code Tipologia/Typology	Disegno/Drawing	Info
-----------------------------------	-----------------	------

900 Tavolo tondo 2 posti 2 seats round table ø60 - H75 Kg 12,2		
--	--	--

902 Tavolo tondo 2/4 posti 2/4 seats round table ø80 - H75 Kg 16,7		
--	--	--

COLORI STRUTTURA—FRAME COLORS

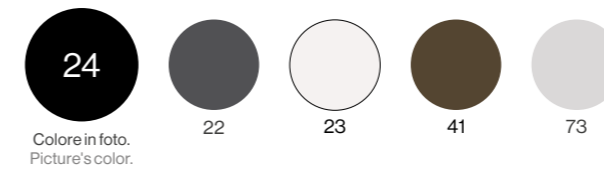

PLUS

- Piano in lamiera piena particolarmente adatto ad un utilizzo contract poiché protegge le gambe in caso di caduta di liquidi sulla sua superficie.— Sheet top particularly suitable to contract use since the liquids don't go through the surface.
- Tavolo con base e palo centrale tondi; piano realizzato in lamiera zincata a caldo.
Table with a round base and central pole. Hot-dip zincated sheet table top.
- Facile da montare.— Easy to assemble.
- Il basamento realizzato in lamiera di acciaio garantisce un'ottima stabilità.
The base made of steel sheet ensures an excellent stability.
- Elegante ed essenziale nelle linee si combina con tutti i prodotti realizzati con tubi tondi.
It matches with all products made of round pipes. Elegant and essential design.

EMU NEL MONDO EMU IN THE WORLD

ROUND—THE ORANGE CUBE—FRANCE

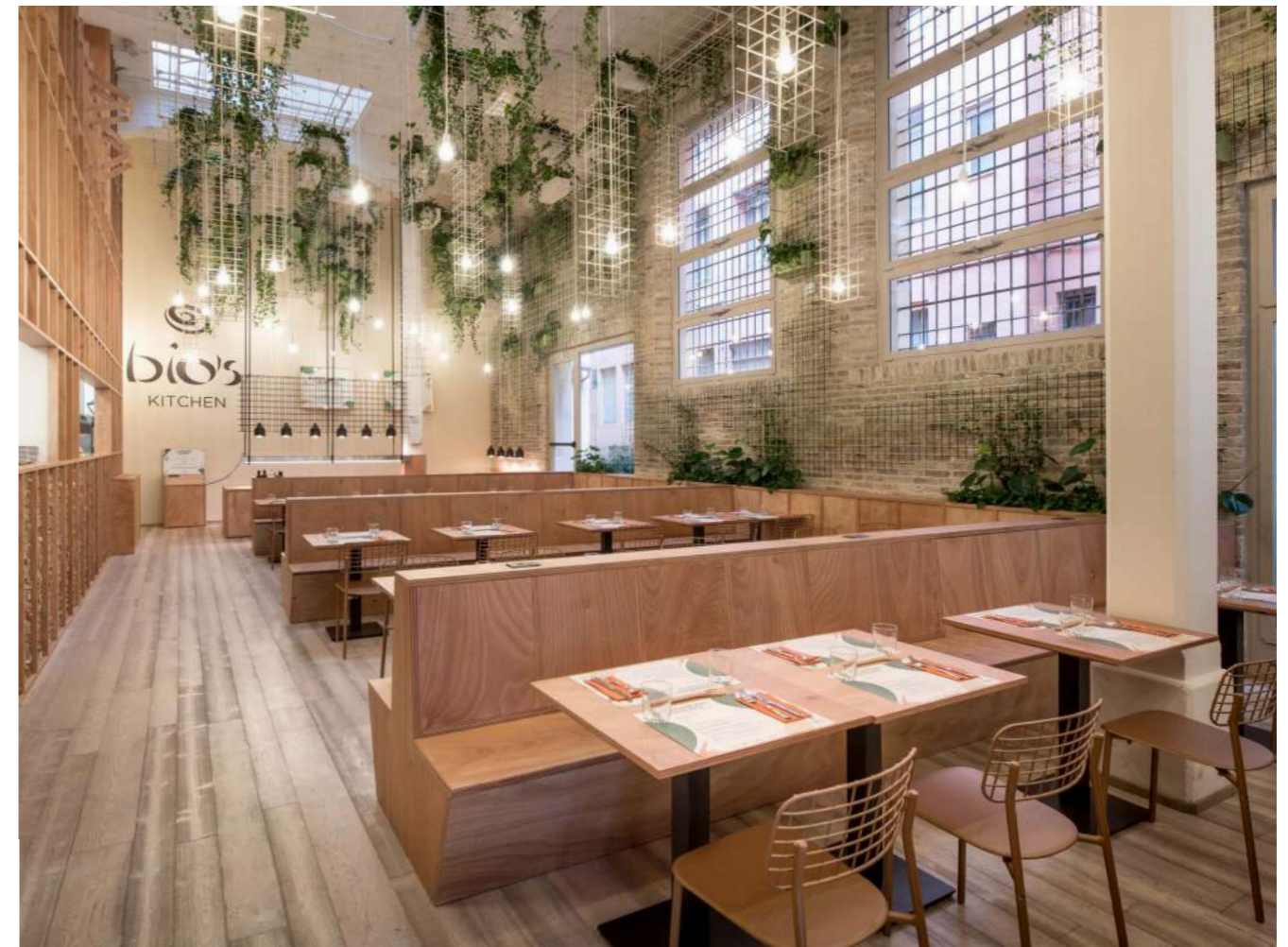

LYZE—BIO'S KITCHEN—ITALY



RE-TROUVÉ—HOTEL ME SITGES—SPAIN



POLTRONE E DIVANI ARMCHAIRS AND SOFAS

Versatilità, comfort, modularità e ricerca estetica caratterizzano le poltrone e i divani EMU. L'ampia gamma di tessuti permette di personalizzare i cuscini di seduta, così come i cuscini decorativi offerti in varie misure, per creare eleganti soluzioni di arredo. L'offerta si completa con divani a 2 e 3 posti e alcuni accessori, come tavoli orientabili, tavoli bassi e snack.

EMU modular armchairs and sofas are versatile, comfortable and elegant. The extensive range of fabrics offers customizable seating cushions and decorative cushions, available in various sizes to create elegant furnishings. 2 and 3-seater sofas, some accessories, such as adjustable, coffee and snack tables complete the range.

INDEX

226	ANGEL	●
230	CABLA	●
236	CANNOLÈ	●
242	IVY	●
244	REEL	●
248	TAMI	● ●
256	TERRA	●
260	TERRAMARE	●
264	TWINS	● ●

LEGENDA—LEGEND

- Acciaio—Steel
- Alluminio—Aluminium
- Legno—Wood



Scansiona e scopri i progetti.
Scan and discover the projects.



9045
Poltrona
Lounge chair
W97 - D86,5 - H78

C/9045 + C/9044



C/9045, C/9046, cuscini sedile e schienale per poltrona e divano 2 posti: sono tra loro fissati tramite apposita zip.
C/9045, C/9046, seat and back cushions for armchair and 2-seater sofa: they are fixed using a special zip.

* Cuscino visibile in foto 900/18 Madreperla—Cushion in the picture 900/18 Nacre

9046
Divano 2 posti
2-Seater sofa
W180 - D86,5 - H78

C/9045 + C/9044



Struttura dall'estetica caratterizzante grazie al design del profilo di alluminio esclusivo EMU.
Characterizing aesthetics frame thanks to the design of the exclusive EMU aluminum profile.

* Cuscino visibile in foto 900/18 Madreperla—Cushion in the picture 900/18 Nacre

ALTRI PRODOTTI IN COLLEZIONE—OTHER COLLECTION'S PRODUCTS



ANGEL
Cod. 9055
Tavolo basso
Coffee table
PAG. 276



ANGEL
Cod. 9042
Poltroncina
Armchair
PAG. 20



ANGEL
Cod. 9051
Tavolo tondo 6 posti
6 seats round table
PAG. 148

PRODOTTI—PRODUCTS

Codice/Code Tipologia/Typology	Disegno/Drawing	Info
-----------------------------------	-----------------	------

9045
Struttura poltrona
Lounge chair frame
W97 - D86,5 - H78
Kg 9,4

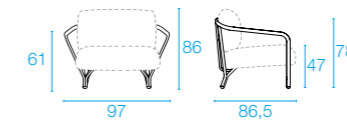



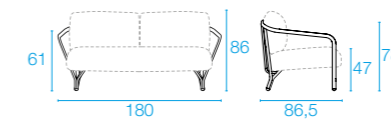



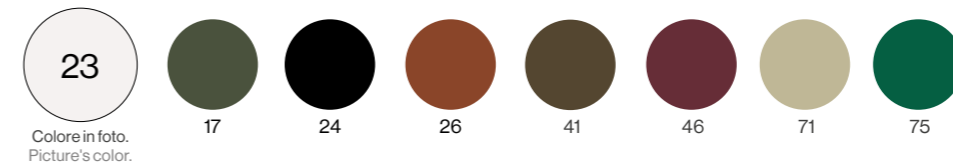



9046
Struttura divano 2 posti
2-Seater sofa frame
W180 - D86,5 - H78
Kg 16,0



COLORI STRUTTURA—FRAME COLORS



CUSCINI—CUSHIONS

Codice/Code Tipologia/Typology	Colori tessuto Fabric colors	Categoria tessuto Fabric category
C/9045 Kit cuscino seduta e schienale Seat and back cushion kit x cod. 9045 W77 - D46 - H20 W80 - D80 - H20 Kg 6,6	 	Tessuti Basic (Vedi riepilogo pg. 228) Tessuti Standard (Vedi riepilogo pg. 228)* Tessuti Exclusive (Vedi riepilogo pg. 228) Vedi pg. 228 Look at pg. 228 Basic Fabrics (Look at pg. 228) Standard Fabrics (Look at pg. 228)* Exclusive Fabrics (Look at pg. 228)
C/9046 Kit cuscino seduta e schienale Seat and back cushion kit x cod. 9046 W77 - D46 - H20 W155 - D80 - H20 Kg 13,1	 	Tessuti Basic (Vedi riepilogo pg. 228) Tessuti Standard (Vedi riepilogo pg. 228)* Tessuti Exclusive (Vedi riepilogo pg. 228) Vedi pg. 228 Look at pg. 228 Basic Fabrics (Look at pg. 228) Standard Fabrics (Look at pg. 228)* Exclusive Fabrics (Look at pg. 228)
C/9044 Kit n.2 cuscini bracciolo N.2 armrest cushions kit x cod. 9045,9046 W50 - D56 - H8 Kg 1,8	 	Tessuti Basic (Vedi riepilogo pg. 228) Tessuti Standard (Vedi riepilogo pg. 228)* Tessuti Exclusive (Vedi riepilogo pg. 228) Vedi pg. 228 Look at pg. 228 Basic Fabrics (Look at pg. 228) Standard Fabrics (Look at pg. 228)* Exclusive Fabrics (Look at pg. 228)
FC/729 Cover x cod. 9045	 	
FC/730 Cover x cod. 9046	 	



Scansiona e scopri i progetti.
Scan and discover the projects.

TESSUTI CUSCINI—CUSHION FABRICS

C/9044 - C/9045 - C/9046

Composizione/Categoria tessuti Composition/Fabrics category	Colori Colors
TESSUTI BASIC—BASIC FABRICS	
Acrilico—Acrylic	700/4
	700/10
	700/13
	700/32
700/34	
TESSUTI STANDARD—STANDARD FABRICS	
88% Acrilico, 12% Poliestere—88% Acrylic, 12% Polyester	900/02
	900/05
	900/07
	900/08
	900/09
Acrilico—Acrylic	900/18
	900/71
	900/75
	900/77
	900/77
TESSUTI EXCLUSIVE—EXCLUSIVE FABRICS	
CAT. E Visitare il nostro sito web www.emu.it —Visit our website www.emu.it	600/31
	600/32
	600/33
	600/34
	600/35
	600/36
	600/37
	600/38
	600/39
	600/40
600/41	
CAT. D Visitare il nostro sito web www.emu.it —Visit our website www.emu.it	600/42
	600/43
	600/48
	600/49
	600/27
	900/16
	600/07
	600/14
	600/16
	600/18
600/11	
CON TESSUTO CLIENTE—WITH CUSTOMER'S FABRIC	
FABBISOGNO TESSUTO (cm)—FABRIC REQUIRED (cm)	C/9044 132x220, C/9045 132x280, C/9046 132x550

CUSCINI—CUSHIONS



Codice/Code Tipologia/Typology	Colori tessuto Fabric colors	Categoria tessuto Fabric category
C/701 Cuscino decorativo Decorative cushion x cod. 1080, 1081, 1082, 1083, 1084 W40 - D40 - H15 Kg 0,7		Vedi pg. 369 Look at pg. 369
C/705 Cuscino decorativo Decorative cushion x cod. 1080, 1081, 1082, 1083, 1084 W45 - D35 - H15 Kg 0,7		
C/706 Cuscino decorativo Decorative cushion x cod. 1080, 1081, 1082, 1083, 1084 W60 - D40 - H20 Kg 0,9		
		Tessuti Basic (Vedi riepilogo pg. 369) Tessuti Standard (Vedi riepilogo pg. 369) Tessuti Exclusive (Vedi riepilogo pg. 369) Basic Fabrics (Look at pg. 369) Standard Fabrics (Look at pg. 369) Exclusive Fabrics (Look at pg. 369)

PLUS

- Il divano 2 posti e la poltrona lounge sono leggeri e maneggevoli grazie all'utilizzo dell'alluminio come materiale portante e delle cinghie elastiche di seduta, intrecciate e fissate come da soluzione tecnica esclusiva e brevettata da EMU.—The 2-seater sofa and lounge chair are light and easy to handle thanks to the use of aluminium as main material and elastic seat belts, woven and fixed as the exclusive technical solution patented by EMU.
- I cuscini sono sfoderabili e disponibili in un'ampia gamma di tessuti.—The cushions have removable covers and are available in a wide range of fabrics.
- Il cuscino schienale è composta da uno strato superiore di fiocchi di poliestere e sostenuto da uno strato inferiore di poliuretano espanso. Il cuscino sedile è costituito da poliuretano di due diverse densità ed è fissato alla seduta anteriormente tramite pratico sistema.—The back cushion is made of an upper layer of polyester wads, supported by a lower layer of polyurethane foam. The seat cushion is made of polyurethane of two different densities and is fixed to the seat at the front using a practical system.
- C/9044 kit 2 cuscini bracciolo: cuscini braccioli disponibili come optional per una versione ricca e dal comfort massimo. Tali cuscini di fissano alla seduta tramite appositi particolari.—C/9044 kit of 2 armrest cushions: armrest cushions available as an option for a rich version with maximum comfort. These cushions are fixed to the seat using special details.
- C/9044, C/9045, C/9046 sono sfoderabili.—C/9044, C/9045, C/9046 are cover removable cushions.
- Ispirazione neoclassica che qualifica la collezione per differenti destinazioni d'uso di tipologia contract, sia dining che lounge.
Neoclassical inspiration that qualifies the collection for different contract uses, whether dining or lounge.



Scansiona e scopri i progetti.
Scan and discover the projects.



5036+5038+5039

Poltrona
Lounge chair
W109- D88 - H75

C/5036 + C/5038 + C/5039



Bracciolo sagomato tramite stampo che conferisce, oltre al design caratteristico, ergonomia alla struttura. L'imbottitura è sagomata al fine di conferire la forma distintiva ed ergonomica dei cuscini, sia di seduta che schienale e braccioli. Molded armrest which gives the frame ergonomics as well as a characteristic design. The padding is modelled to provide a distinctive and ergonomic shape to seat, backrest and armrest cushions.



Fissaggio tra cuscino sedile e schienale tramite apposita zip, per un miglior comfort in uso. Back and seat cushion fastening with a zip, for a great comfort.

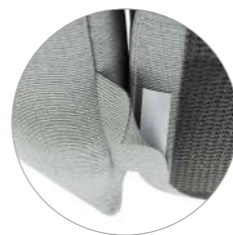

I cuscini bracciolo sono accoppiati ai cuscini laterali tramite dettaglio in velcro presente sotto ogni cuscino sedile e bracciolo. The armrest cushions are fastened to the lateral cushion by a Velcro detail under each seat and armrest cushion.

* Cuscino visibile in foto 900/09 Salvia—Cushion in the picture 900/09 Sage

2x5036+5038+5039

Divano 2 posti—2-Seater sofa
W184 - D88 - H75

2 x C/5036 + C/5038 + C/5039



* Cuscino visibile in foto 900/09 Salvia—Cushion in the picture 900/09 Sage

3x5036+5038+5039

Divano 3 posti—3-Seater sofa
W259 - D88 - H75

3 x C/5036 + C/5038 + C/5039



2x5036+5037+5038+5039

Divano 3 posti con daybed
3-Seater sofa with daybed
W259 - D144 - H75

2 x C/5036 + C/5037 + C/5038 + C/5039



5x5036+5038+5039+5051

Divano angolare 5 posti
5-Seater corner sofa
W330 - D255 - H75

5 x C/5036 + C/5038 + C/5039



2x5037+5038+5039

Chaise longue doppia
Double chaise longue
W184 - D145 - H75

2 x C/5037 + C/5038 + C/5039



* Cuscino visibile in foto 900/09 Salvia—Cushion in the picture 900/09 Sage



Scansiona e scopri i progetti.
Scan and discover the projects.

PRODOTTI—PRODUCTS

Codice/Code Tipologia/Typology	Disegno/Drawing	Info
5036 Struttura modulo lineare Straight module frame W75 - D87,5 - H58,5 Kg 11,2		
5037 Struttura chaise longue Chaise longue frame W75 - D144 - H59 Kg 14,3		
5038 Struttura bracciolo dx Right armrest frame W70 - D17 - H39 Kg 3,9		
5039 Struttura bracciolo sx Left armrest frame W70 - D17 - H39 Kg 3,9		
5051 Tavolo angolare Corner table W74 - D74 - H24 Kg 9,8		

COLORI STRUTTURA—FRAME COLORS

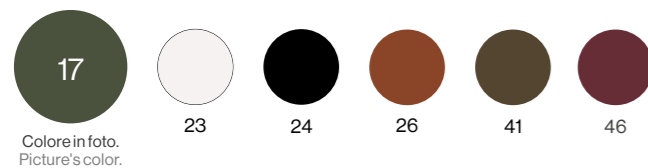

ALTRI PRODOTTI IN COLLEZIONE—OTHER COLLECTION'S PRODUCTS



CABLA
Cod. 5047
Tavolo basso
Coffee table
PAG. 280



CABLA
Cod. 5050
Tavolo basso
Coffee table
PAG. 280

CUSCINI—CUSHIONS



Codice/Code Tipologia/Typology	Colori tessuto Fabric colors	Categoria tessuto Fabric category
C/5036 Cuscino seduta e schienale Seat and back cushion x cod. 5036 W115 - D75 - H25 Kg 6,5		Vedi pg. 235 Look at pg. 235
C/5037 Cuscino seduta e schienale Seat and back cushion x cod. 5037 W172 - D75 - H25 Kg 10,1		
C/5038 Cuscino bracciolo dx Right armrest cushion x cod. 5038 W76 - D53 - H20 Kg 1,6		
C/5039 Cuscino bracciolo sx Left armrest cushion x cod. 5039 W76 - D53 - H20 Kg 1,6		

Tessuti Basic (Vedi riepilogo pg. 235)
Tessuti Standard (Vedi riepilogo pg. 235)*
Tessuti Exclusive (Vedi riepilogo pg. 235)
Basic Fabrics (Look at pg. 235)
Standard Fabrics (Look at pg. 235)*
Exclusive Fabrics (Look at pg. 235)

PLUS

- **Struttura realizzata interamente in tubolare a sezione rettangolare in acciaio inossidabile AISI 304, sagomato tramite robot curvatubi di precisione e tagliato tramite tecnologia laser al fine di creare corrispondenze e incastri tra tubolari molto precisi e disegnati.**—Frame entirely made of rectangular profile pipe in AISI 304 stainless steel, shaped by precision tube bending robots and cut by laser technology, to create precise junctions between the tubulars.
- **Possibilità di creare molteplici combinazioni adatte a diverse funzionalità e contesti di utilizzo.**
Multiple combinations suitable for different functions and contexts of use.
- **Varietà di composizioni possibili grazie all'eventuale utilizzo del modulo bracciolo e del relativo cuscino: ciascun elemento lounge, che sia una poltrona, un divano a due posti o una composizione angolare, può vivere in una forma più snella senza braccioli, o in una forma più ricca che li comprenda.**—Variety of possible compositions thanks to the use of the armrest and its cushion: each element, either an armchair, a two-seater sofa, or a corner composition, can be assembled with or without armrests, thus obtaining a more essential composition or a richer one.
- **Flessibilità e componibilità dei vari elementi imbottiti.**—Flexibility and modularity of the various upholstered elements.
- **Acciaio inossidabile come materiale principale, a contesti marini e all'utilizzo su imbarcazioni.**
The main material is stainless steel, suitable to marine environment and boats.
- **Cuscini sfoderabili e personalizzabili in un'ampia gamma di tessuti.**—Cushions are cover removable and customizable, available in a wide range of fabrics.
- **Imbottitura interna in gomma poliuretana di diverse densità unita ad uno strato di resinato accoppiato. Le densità variano tra i vari cuscini (intesi come cuscino sedile, cuscino schienale e cuscino bracciolo), al fine di studiare il bilanciamento migliore tra comfort e sostegno di ogni tipologia di cuscino.**—Inner padding in polyurethane rubber of different densities combined with a layer of bonded resin. The densities vary between the cushions (intended as seat cushions, back cushions, and armrest cushions), in order to achieve the best balance between comfort and support for each type of cushion.
- **L'antislittamento del cuscino in uso è garantito non solo dallo strato di antiscivolo inferiore ma soprattutto da un sistema di aggancio tramite un elemento elastico che permettono l'incastro del cuscino sulle due asole presenti nella struttura di seduta.**—The cushion anti-slip is guaranteed not only by the lower non-slip layer but above all by a hooking system made of an elastic element that allows the cushion to fit onto the two slots present in the seat frame.



Scansiona e scopri i progetti.
Scan and discover the projects.

CUSCINI—CUSHIONS

Codice/Code Tipologia/Typology	Colori tessuto Fabric colors	Categoria tessuto Fabric category
C/701 Cuscino decorativo Decorative cushion x cod. 1080, 1081, 1082, 1083, 1084 W40 - D40 - H15 Kg 0,7		Tessuti Basic (Vedi riepilogo pg. 369) Tessuti Standard (Vedi riepilogo pg. 369) Tessuti Exclusive (Vedi riepilogo pg. 369) Basic Fabrics (Look at pg. 369) Standard Fabrics (Look at pg. 369) Exclusive Fabrics (Look at pg. 369)
C/705 Cuscino decorativo Decorative cushion x cod. 1080, 1081, 1082, 1083, 1084 W45 - D35 - H15 Kg 0,7		
C/706 Cuscino decorativo Decorative cushion x cod. 1080, 1081, 1082, 1083, 1084 W60 - D40 - H20 Kg 0,9		
FC/729 Cover x cod. 5036+5038+5039		
FC/5037 Cover x cod. 5037, 5037+5038, 5037+5039, 5037+5038+5039		
FC/730 Cover x cod. 2x5036+5038+5039		
FC/6047 Cover x cod. 3x5036+5038+5039		



TESSUTI CUSCINI—CUSHION FABRICS C/5036 - C/5037 - C/5038 - C/5039

Composizione/Categoria tessuti Composition/Fabrics category	Colori Colors
TESSUTI BASIC—BASIC FABRICS	
Acrilico—Acrylic	700/4 700/10 700/13 700/32 700/34
TESSUTI STANDARD—STANDARD FABRICS	
88% Acrilico, 12% Poliestere—88% Acrylic, 12% Polyester	900/02 900/05 900/07 900/08 900/09 900/18 900/71 900/75 900/77
Acrilico—Acrylic	
TESSUTI EXCLUSIVE—EXCLUSIVE FABRICS	
CAT. E Visitare il nostro sito web www.emu.it —Visit our website www.emu.it	600/31 600/32 600/33 600/34 600/35 600/36 600/37 600/38 600/39 600/40 600/41 600/42 600/43 600/48 600/49 600/27 900/16 600/07 600/14 600/16 600/18 600/11
CAT. D Visitare il nostro sito web www.emu.it —Visit our website www.emu.it	
CAT. C Visitare il nostro sito web www.emu.it —Visit our website www.emu.it	
CAT. B Visitare il nostro sito web www.emu.it —Visit our website www.emu.it	
CON TESSUTO CLIENTE—WITH CUSTOMER'S FABRIC	
FABBISOGNO TESSUTO (cm)—FABRIC REQUIRED (cm)	C/5036 132x250, C/5037 132x400, C/5038 132x110, C/5039 132x110



Scansiona e scopri
i progetti.
Scan and discover
the projects.



1080

Poltrona

Lounge chair

W96 - D90 - H79

C/1080 + C/1081 + C/1082 + C/1083



Tutte le componenti in acciaio, i
tondini e i tubi sono zincati a caldo
internamente ed esternamente.
All steel components, bars and
pipes are both internally and
externally hot-dip zincated.

*Cuscino visibile in foto 900/02 Mare—Cushion in the picture 900/02 Sea

1085

Pouf

Pouf

W85 - D85 - H43

C/1085



*Cuscino visibile in foto 900/02 Mare—Cushion in the picture 900/02 Sea

1082+1083

Divano 2 posti—2-Seater sofa

W180 - D90 - H79

2x C/1080 + 2x C/1081 + C/1082 + C/1083

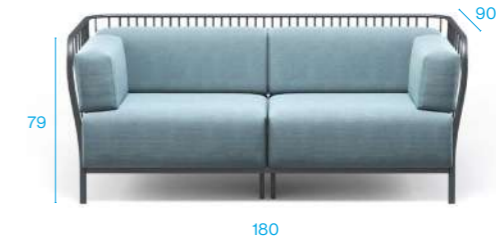

1081+1082+1083

Divano 3 posti—3-Seater sofa

W265 - D90 - H79

3x C/1080 + 3x C/1081 + C/1082 + C/1083



1081+1082+1083+1085

Divano 3 posti con daybed

3-Seater sofa with daybed

W265 - D175 - H79

3x C/1080 + 3x C/1081 + C/1082 +
C/1083 + C/1086



2x1081+1082+1083+1084

Divano angolare 5 posti

5-Seater corner sofa

W265 - D265 - H79

4x C/1080 + 4x C/1081 + C/1082 +
C/1083 + C/1084 + C/1085



1082+1083+2x1085

Daybed matrimoniale

Double daybed

W180 - D175 - H79

2x C/1080 + 2x C/1081 + C/1082 +
C/1083 + 2x C/1086



*Cuscino visibile in foto 900/02 Mare—Cushion in the picture 900/02 Sea



Scansiona e scopri i progetti.
Scan and discover the projects.

PRODOTTI—PRODUCTS

Codice/Code Tipologia/Typology	Disegno/Drawing	Info	TEST
1080 Struttura poltrona Lounge chair frame W96 - D90 - H79 Kg 20,4			EN581-1/ EN581-2
1081 Modulo lineare Straight module W85 - D90 - H79 Kg 13,5			
1082 Modulo terminale dx Right end module W90 - D90 - H79 Kg 16,9			
1083 Modulo terminale sx Left end module W90 - D90 - H79 Kg 16,9			
1084 Modulo angolare Corner module W90 - D90 - H79 Kg 19,6			
1085 Modulo pouf Pouf module W85 - D85 - H20 Kg 9,6			

COLORI STRUTTURA—FRAME COLORS

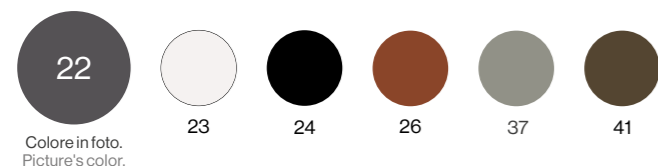

ALTRI PRODOTTI IN COLLEZIONE—OTHER COLLECTION'S PRODUCTS

238



CANNOLE
Cod. 1087
Tavolo basso grande
Big coffee table
PAG. 282



CANNOLE
Cod. 1088
Tavolo basso piccolo
Small coffee table
PAG. 282

CUSCINI—CUSHIONS



Codice/Code Tipologia/Typology	Colori tessuto Fabric colors	Categoria tessuto Fabric category
C/1080 Cuscino seduta—Seat cushion x cod. 1080, 1081, 1082, 1083 W84 - D23 - H84 Kg 4,4		Vedi pg. 241 Look at pg. 241
C/1081 Cuscino schienale—Back cushion x cod. 1080, 1081, 1082, 1083 W84 - D30 - H33 Kg 1,6		
C/1082 Cuscino bracciolo dx—Right armrest cushion x cod. 1080, 1082 W69 - D18 - H31 Kg 0,9		
C/1083 Cuscino bracciolo sx—Left armrest cushion x cod. 1080, 1083 W69 - D18 - H31 Kg 0,9		
C/1084 Cuscino schienale angolare—Corner back cushion x cod. 1084 W84 - D33 - H30 Kg 2,8		
C/1085 Cuscino seduta angolare—Corner seat cushion x cod. 1084 W84 - D23 - H84 Kg 4,4		
C/1086 Cuscino pouf—Pouf cushion x cod. 1085 W84 - D23 - H84 Kg 4,0		

Tessuti Basic (Vedi riepilogo pg. 241)
Tessuti Standard (Vedi riepilogo pg. 241)*
Tessuti Exclusive (Vedi riepilogo pg. 241)
Basic Fabrics (Look at pg. 241)
Standard Fabrics (Look at pg. 241)*
Exclusive Fabrics (Look at pg. 241)

PLUS

- La spaziatura dei tondini irregolare segue una sapiente gradualità che conferisce grande personalità al design del prodotto.—The irregular bars pattern is wisely graded and gives great personality to the product design.
- Cuscino dotato di sistema antiscivolo.—Non-slip layer under the cushion.
- Cover imbottitura interna impermeabile. Imbottitura interna in poliester e poliuretano espanso. Water-proof inner lining. Polyester and expanded polyurethane inner padding.
- Ampia gamma di tessuti disponibili.—Wide fabrics range.
- Disponibili cover di protezione.—Protecting covers are available.
- Giunti di accoppiamento e viterie in acciaio inossidabile.—Stainless steel coupling joints and screws.
- Il cuscino del pouf è fissato alla struttura tramite velcro.—The pouf cushion fastening to the frame is guaranteed by velcro.

239



Scansiona e scopri i progetti.
Scan and discover the projects.



CUSCINI—CUSHIONS

Codice/Code Tipologia/Typology	Colori tessuto Fabric colors	Categoria tessuto Fabric category
C/701 Cuscino decorativo Decorative cushion x cod. 1080, 1081, 1082, 1083, 1084 W40 - D40 - H15 Kg 0,7		Tessuti Basic (Vedi riepilogo pg. 369) Tessuti Standard (Vedi riepilogo pg. 369) Tessuti Exclusive (Vedi riepilogo pg. 369) Basic Fabrics (Look at pg. 369) Standard Fabrics (Look at pg. 369) Exclusive Fabrics (Look at pg. 369)
C/705 Cuscino decorativo Decorative cushion x cod. 1080, 1081, 1082, 1083, 1084 W45 - D35 - H15 Kg 0,7		
C/706 Cuscino decorativo Decorative cushion x cod. 1080, 1081, 1082, 1083, 1084 W60 - D40 - H20 Kg 0,9		
FC/729 Cover x cod. 1080		
FC/742 Cover x cod. 1082+1083		
FC/743 Cover x cod. 1081+1082+1083		
FC/1085 Cover x cod. 1085		

TESSUTI CUSCINI—CUSHION FABRICS

C/1080 - C/1081 - C/1082 - C/1083 - C/1084 - C/1085 - C/1086

Composizione/Categoria tessuti Composition/Fabrics category	Colori Colors
TESSUTI BASIC—BASIC FABRICS	
Acrilico—Acrylic	700/4 700/10 700/13 700/32 700/34
TESSUTI STANDARD—STANDARD FABRICS	
88% Acrilico, 12% Poliestere—88% Acrylic, 12% Polyester	900/02 900/05 900/07 900/08 900/09 900/18 900/71 900/75 900/77
Acrilico—Acrylic	
TESSUTI EXCLUSIVE—EXCLUSIVE FABRICS	
CAT. E Visitare il nostro sito web www.emu.it —Visit our website www.emu.it	600/31 600/32 600/33 600/34 600/35 600/36 600/37 600/38 600/39 600/40 600/41 600/42 600/43 600/48 600/49 600/27 900/16 600/07 600/14 600/16 600/18 600/11
CAT. D Visitare il nostro sito web www.emu.it —Visit our website www.emu.it	
CAT. C Visitare il nostro sito web www.emu.it —Visit our website www.emu.it	
CAT. B Visitare il nostro sito web www.emu.it —Visit our website www.emu.it	
CON TESSUTO CLIENTE—WITH CUSTOMER'S FABRIC	
FABBISOGNO TESSUTO (cm)—FABRIC REQUIRED (cm)	C/1080 132x240, C/1081 132x160, C/1082 132x100, C/1083 132x100 C/1084 132x240, C/1085 132x240, C/1086 132x280



Scansiona e scopri i progetti.
Scan and discover the projects.

585+C/585
Poltrona
Lounge chair



La lamiera stirata prezinata viene saldata a proiezione ai toncini perimetrali e successivamente cataforizzata. The pre hot-dip zined expanded sheet is spot welded and cataphorised later on.

586
Divano
Sofa



Tale tipologia di lamiera, esclusiva per la collezione Ivy, viene modellata tramite stampo per conferire ergonomia alle sedute. This type of sheet is exclusively used for the Ivy collection. It is moulded to make the seating collection extremely ergonomic.

PRODOTTI—PRODUCTS



Codice/Code Tipologia/Typology	Disegno/Drawing	Info
585 Poltrona—Lounge chair W110 - D90 - H66 Kg 16,2		
586 Divano—Sofa W192 - D90 - H66 Kg 25,2		

COLORI STRUTTURA—FRAME COLORS



Colore in foto.
Picture's color.

CUSCINI—CUSHIONS

Codice/Code Tipologia/Typology	Colori tessuto Fabric colors	Categoria tessuto Fabric category
C/585 Cuscino seduta e schienale acrilico Acrylic seat and back cushion x cod. 585 W70 - D64 - H5 Kg 1,1	900/71* 	Tessuti Standard Standard Fabrics
C/586 Cuscino seduta e schienale acrilico Acrylic seat and back cushion x cod. 586 W70 - D148 - H5 Kg 3,6	900/71 	Tessuti Standard Standard Fabrics
C/701 Cuscino decorativo—Decorative cushion x cod. 585, 586 W40 - D40 - H15 Kg 0,7		Tessuti Basic (Vedi riepilogo pg. 369) Tessuti Standard (Vedi riepilogo pg. 369) Tessuti Exclusive (Vedi riepilogo pg. 369) Basic Fabrics (Look at pg. 369) Standard Fabrics (Look at pg. 369) Exclusive Fabrics (Look at pg. 369)
C/705 Cuscino decorativo—Decorative cushion x cod. 585, 586 W45 - D35 - H15 Kg 0,7		
C/706 Cuscino decorativo—Decorative cushion x cod. 585, 586 W60 - D40 - H20 Kg 0,9		

* Cuscino visibile in foto—Cushion in the picture

ALTRI PRODOTTI IN COLLEZIONE—OTHER COLLECTION'S PRODUCTS



IVY
Cod. 589
Tavolo basso
Coffee table
PAG. 294

REEL

Design by Pio e Tito Toso



Scansiona e scopri i progetti.
Scan and discover the projects.

180S+180T+C/180
Dondolo divano
Rocking sofa



Schienale reclinabile in 4 posizioni differenti.
Reclining backrest in four different positions.

* Cuscino visibile in foto 900/09 Salvia—Cushion in the picture 900/09 Sage



Estraendo il perno dalla cremagliera e assicurando il fissaggio sul tubo posteriore, si può ottenere un daybed matrimoniale.
Getting the pivot out the rack and fixing the back to the frame, the big daybed comes out.



Ruotando in senso orario entrambi i meccanismi laterali, il tettino può essere spostato anteriormente o posteriormente.
Clocking wise the side elements, the roof could be moved back and forth.

PRODOTTI—PRODUCTS



Codice/Code Tipologia/Typology	Disegno/Drawing	Info
180S Struttura dondolo divano Rocking sofa frame W286 - D138 - H200 Kg 78,3		
180T Tettino dondolo divano Rocking sofa roof		
180B Borsa portaoggetti in eco-cuoio Eco-leather storage bag W33 - D10 - H30 Kg 0,3		
180P Piano in teak Teak shelf W55 - D22 - H2,5 Kg 2,4		

COLORI STRUTTURA/TETTINO/TIRANTI X COD. 180S—FRAME/TOP/ROPE COLORS X COD. 180S

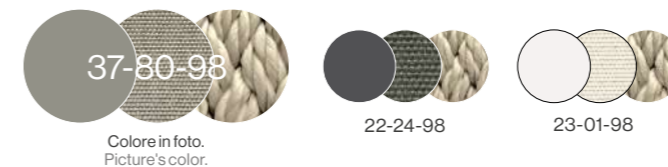

COLORI STRUTTURA X COD. 180T, 180B—FRAME COLORS X COD. 180T, 180B

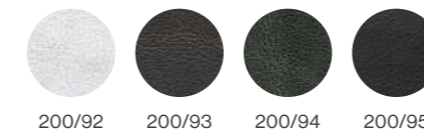





COLORI STRUTTURA X COD. 180P—FRAME COLORS X COD. 180P

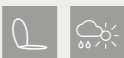

PLUS

- Dondolo dalle dimensioni generose, da tre e più posti. Struttura in tubolare di acciaio zincato a caldo, sedile e schienale in lamiera stirata, per una elevata solidità strutturale.—3-Seater and more huge rocking sofa. Pre-hot dip zincated tubular frame, seat and back in expanded metal sheet for a high structural resistance.
- Cuscino effetto imbottito, sagomato e dotato di uno strato di tessuto antiscivolo. Disponibile in un'ampia gamma di tessuti.—Upholstered cushion with an underneath anti-slip layer. Available in a wide colors range.
- Tettino inclinabile per aumentare la superficie ombreggiata.
Reclining roof to increase shade when seated under.
- Rimuovendo il copritesta e allentando le viti lungo il tubo di struttura, il telo può essere sfilato, per una facile sostituzione del tessuto.— Removing the caps and loosening the screws, the cloth could be removed and changed for replacement if necessary.
- Piastre di appoggio con foro per fissaggio a terra.— Ground feet with hole for fastening.
- Elegante tasca accessoria in ecopelle, che funge da contenitore occasionale.
Refined accessory side pocket in eco-leather that can be used as a case.
- Piccolo tavolo accessorio.— Small accessory table.

CUSCINI—CUSHIONS

Codice/Code Tipologia/Typology	Colori tessuto Fabric colors	Categoria tessuto Fabric category
C/180 Cuscino seduta e schienale Seat and back cushion x cod. 180 W192 - D110 - H9 Kg 6,4	 Vedi pg. 247 Look at pg. 247	Tessuti Basic (Vedi riepilogo pg. 247) Tessuti Standard (Vedi riepilogo pg. 247)* Tessuti Exclusive (Vedi riepilogo pg. 247) Basic Fabrics (Look at pg. 247) Standard Fabrics (Look at pg. 247)* Exclusive Fabrics (Look at pg. 247)
C/701 Cuscino decorativo Decorative cushion x cod. 180 W40 - D40 - H15 Kg 0,7		Tessuti Basic (Vedi riepilogo pg. 369) Tessuti Standard (Vedi riepilogo pg. 369) Tessuti Exclusive (Vedi riepilogo pg. 369) Basic Fabrics (Look at pg. 369) Standard Fabrics (Look at pg. 369) Exclusive Fabrics (Look at pg. 369)
C/705 Cuscino decorativo Decorative cushion x cod. 180 W45 - D35 - H15 Kg 0,7	 Vedi pg. 369 Look at pg. 369	
C/706 Cuscino decorativo Decorative cushion x cod. 180 W60 - D40 - H20 Kg 0,9		



TESSUTI CUSCINI—CUSHION FABRICS

C/180

Composizione/Categoria tessuti Composition/Fabrics category	Colori Colors
TESSUTI BASIC—BASIC FABRICS	
Acrilico—Acrylic	700/4 700/10 700/13 700/32 700/34
TESSUTI STANDARD—STANDARD FABRICS	
88% Acrilico, 12% Poliestere—88% Acrylic, 12% Polyester	900/02 900/05 900/07 900/08 900/09 900/18 900/71 900/75 900/77
Acrilico—Acrylic	
TESSUTI EXCLUSIVE—EXCLUSIVE FABRICS	
CAT. E Visitare il nostro sito web www.emu.it —Visit our website www.emu.it	600/31 600/32 600/33 600/34 600/35 600/36 600/37 600/38 600/39 600/40 600/41 600/42 600/43 600/48 600/49 600/27 900/16 600/07 600/14 600/16 600/18 600/11
CAT. D Visitare il nostro sito web www.emu.it —Visit our website www.emu.it	
CAT. C Visitare il nostro sito web www.emu.it —Visit our website www.emu.it	
CAT. B Visitare il nostro sito web www.emu.it —Visit our website www.emu.it	
CON TESSUTO CLIENTE—WITH CUSTOMER'S FABRIC	
FABBISOGNO TESSUTO (cm)—FABRIC REQUIRED (cm)	C/180 132x450



Scansiona e scopri i progetti.
Scan and discover the projects.



763+2x761+762

Poltrona
Lounge chair
W132 - D86 - H84

C/770+C/771+2x C/772



Struttura in profilati di alluminio.
Frame in aluminium profiles.

* Cuscino visibile in foto 900/77 Grigio—Cushion in the picture 900/77 Grey

764+2x761+2x762

Divano 2 posti
2-Seater sofa
W205 - D86 - H84

2x C/770+2x C/771+2x C/772



Giunti in pressofusione di alluminio per una migliore ricercatezza estetica.
Aluminium die-cast joints for a better aesthetic refinement.

* Cuscino visibile in foto 900/77 Grigio—Cushion in the picture 900/77 Grey

765+2x761+3x762

Divano 3 posti
3-Seater sofa
W277 - D86 - H84

3x C/770+3x C/771+2x C/772



Doghe in bambù per un piacevole effetto tattile e visivo.
Slats made of bamboo for a pleasant touch, look and feel.

* Cuscino visibile in foto 900/77 Grigio—Cushion in the picture 900/77 Grey

763+764+769+2x761+4x762

Divano angolare 4 posti
4-Seater corner sofa
W338 - D265 - H84

4x C/770+4x C/771+2x C/772



* Cuscino visibile in foto 900/77 Grigio—Cushion in the picture 900/77 Grey



Cuscini seduta antiscivolo con sistema di fissaggio tramite laccetti che si assicurano alla struttura dello schienale con pratici ganci.
Non-slip seat cushions with laces/hooks system fastened to the backrest frame.

PLUS

• Ampia possibilità di soluzioni di arredo personalizzate grazie alle molteplici combinazioni possibili di cuscini e moduli.
Wide range of customizable furnishing solutions thanks to various combinations of cushions and modules.

• Imbottitura interna in poliuretano e poliestere espanso con fodera impermeabile.
Expanded polyurethane and polyester inner padding with waterproof lining.

• Asimmetria della struttura che permette di avere un piano di appoggio laterale.
Asymmetric frame that allows to have an additional side top.

• Elemento angolare prezioso dall'utilizzo di elementi in gres porcellanato utilizzabili come piani di appoggio.— Angular module featured by porcelain stoneware elements as working top.

• Cuscini sfoderabili e personalizzabili con un'ampia gamma di tessuti.
Cushions are cover removable and customizable with a wide fabric range.

• Tavolo orientabile disponibile come accessorio.— Free standing table available as accessory.



763+2x761+762

Poltrona
Lounge chair
W132 - D86 - H84

C/770+C/771+2x C/772



Struttura in profilati di alluminio.
Frame in aluminium profiles.

* Cuscino visibile in foto 900/77 Grigio—Cushion in the picture 900/77 Grey

764+2x761+2x762

Divano 2 posti
2-Seater sofa
W205 - D86 - H84

2x C/770+2x C/771+2x C/772



Giunti in pressofusione di
alluminio per una migliore
ricercatezza estetica.
Aluminium die-cast joints for
a higher aesthetic refinement.

* Cuscino visibile in foto 900/77 Grigio—Cushion in the picture 900/77 Grey

765+2x761+3x762

Divano 3 posti
3-Seater sofa
W277 - D86 - H84

3x C/770+3x C/771+2x C/772



Doghe in WPC, materiale
composito estremamente
resistente.
Slats made of WPC, an extremely
resistant composite material.

* Cuscino visibile in foto 900/77 Grigio—Cushion in the picture 900/77 Grey

763+764+769+2x761+4x762

Divano angolare 4 posti
4-Seater corner sofa
W338 - D265 - H84

4x C/770+4x C/771+2x C/772



* Cuscino visibile in foto 900/77 Grigio—Cushion in the picture 900/77 Grey



Cuscini seduta antiscivolo con sistema di fissaggio tramite laccetti
che si assicurano alla struttura dello schienale con pratici ganci.
Non-slip seat cushions fastened to the backrest frame with laces and hooks.

PRODOTTI—PRODUCTS

Codice/Code Tipologia/Typology	Disegno/Drawing	Info	TEST
763 Struttura poltrona Lounge chair frame W132 - D86 - H25 Kg 35,6/42,3			
764 Struttura divano 2 posti 2-Seater sofa frame W205 - D86 - H25 Kg 50,0/60,4			
765 Struttura divano 3 posti 3-Seater sofa frame W277 - D86 - H25 Kg 64,0/78,0			EN581-1/EN581-2
769 Struttura angolare Angular frame W194 - D86 - H25 Kg 32,1/35,6			
761 Telaio bracciolo Armrest frame W65 - D5 - H35 Kg 1,2			23 900/71 23 900/75 23 900/77 23 900/79 24 900/71 24 900/75 24 900/77 24 900/79
762 Telaio schienale Backrest frame W68 - D5 - H49 Kg 1,6			23 900/71 23 900/75 23 900/77 23 900/79 24 900/71 24 900/75 24 900/77 24 900/79
768 Tavolino orientabile Free standing table W50 - D35 - H40 Kg 2,1			23 24

COLORI STRUTTURA/DOGHE X COD. 763, 764, 765—FRAME/SLATS COLORS X COD. 763, 764, 765

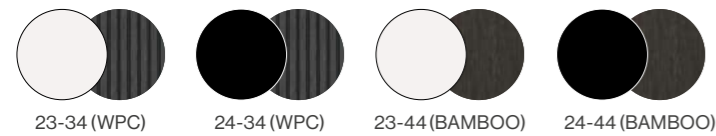

COLORI STRUTTURA/DOGHE/PIANO IN GRES X COD. 769—FRAME/SLATS/GRES TOP COLORS X COD. 769



ALTRI PRODOTTI IN COLLEZIONE—OTHER COLLECTION'S PRODUCTS



CUSCINI—CUSHIONS



Codice/Code Tipologia/Typology	Colori tessuto Fabric colors	Categoria tessuto Fabric category
C/770 Cuscino seduta—Seat cushion x cod. 763, 764, 765, 769 W69 - D69 - H19 Kg 2,3		Vedi pg. 254 Look at pg. 254
C/771 Cuscino schienale—Back cushion x cod. 763, 764, 765, 769 W69 - D43 - H19 Kg 2,2		
C/772 Cuscino bracciolo—Armrest cushion x cod. 763, 764, 765 W67 - D40 - H16 Kg 1,6		
C/773 Cuscino decorativo—Decorative cushion x cod. 763, 764, 765, 769 W55 - D24 - H13 Kg 0,7		
C/701 Cuscino decorativo—Decorative cushion x cod. 763, 764, 765, 769 W40 - D40 - H15 Kg 0,7		Vedi pg. 369 Look at pg. 369
C/705 Cuscino decorativo—Decorative cushion x cod. 763, 764, 765, 769 W45 - D35 - H15 Kg 0,7		
C/706 Cuscino decorativo—Decorative cushion x cod. 763, 764, 765, 769 W60 - D40 - H20 Kg 0,9		
FC/743 Cover x cod. 765		
FC/763 Cover x cod. 763		
FC/764 Cover x cod. 764		

TAMI

Design by Patrick Norguet



Scansiona e scopri
i progetti.
Scan and discover
the projects.

TESSUTI CUSCINI—CUSHION FABRICS C/770 - C/771 - C/772 - C/773

Composizione/Categoria tessuti
Composition/Fabrics category

Colori
Colors

TESSUTI STANDARD—STANDARD FABRICS

Acrilico—Acrylic

900/71
900/75
900/77

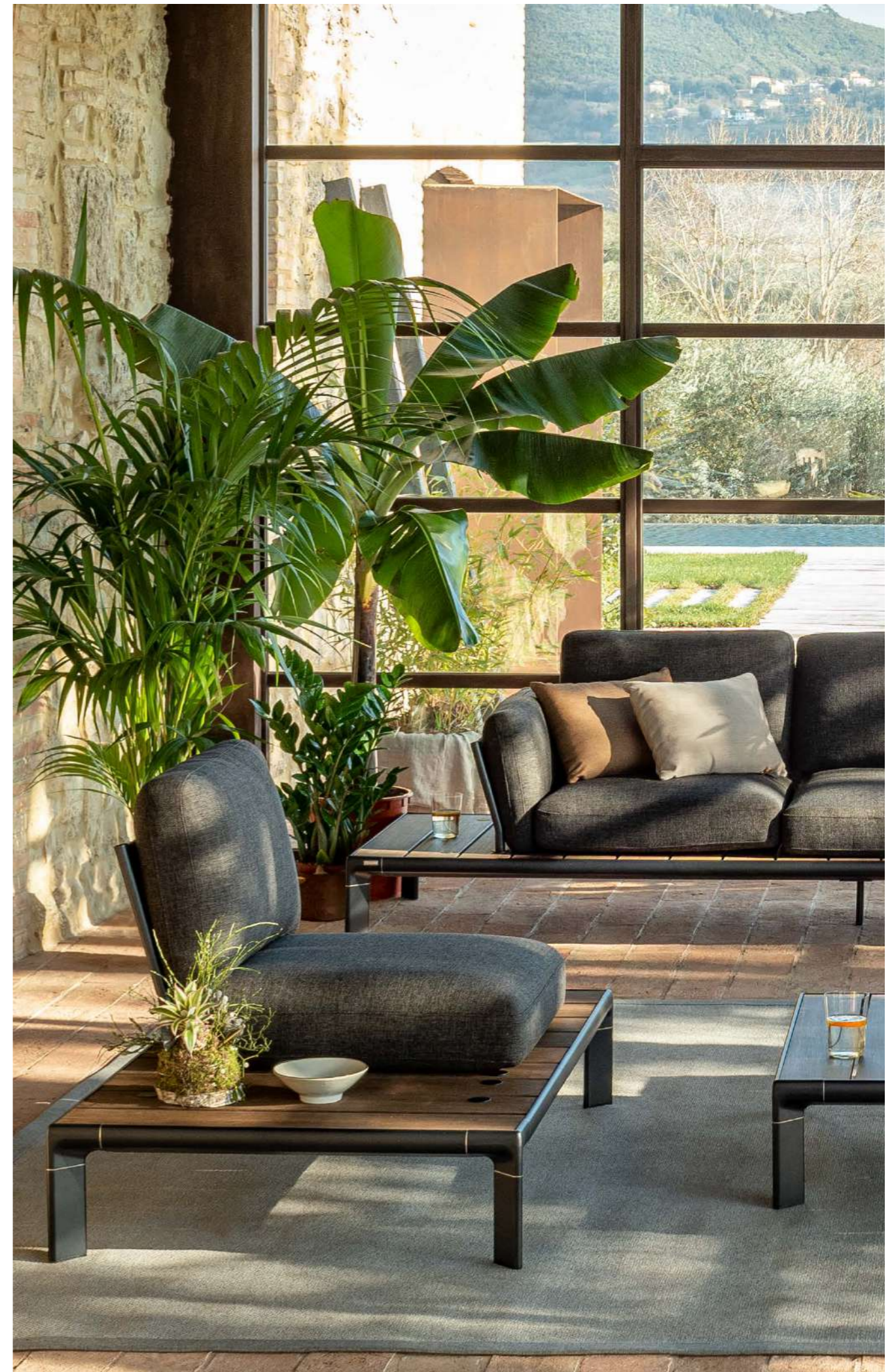



Scansiona e scopri i progetti.
Scan and discover the projects.



721

Poltrona regista pieghevole
Folding director's lounge chair



Lo schienale è montato sulla struttura tramite una clip in acciaio inossidabile che ne garantisce il fissaggio. Allo stesso tempo tale clip può essere facilmente rimossa e permettere la sostituzione dello schienale, quando necessario.
Backrest is assembled and fastened to the frame with a stainless steel clip that could be easily removed to allow the replacement if necessary.

723

Poggiapiedi pieghevole
Folding footstool



Fissaggio cuscino tramite laccetti in corda con clip in acciaio inossidabile. Tale sistema permette di piegare la seduta senza dover rimuovere il cuscino.
Cushion fastening with laces and stainless steel clip that allow to close the armchair without removing it.



Il telo della seduta può essere facilmente sostituito rimuovendo i copri-testa dei profili in alluminio.
Armchair seat cloth could be easily replaced removing frontal caps.

COMBINAZIONI CONSIGLIATE—SUGGESTED MATCHINGS



TAMI
Cod. 763+2x761+762
Poltrona
Lounge chair
PAG. 248



YARD
Cod. 509
Tavolo basso
Coffee table
PAG. 306



TERRAMARE
Cod. 732+735P
Tavolo basso piccolo
Small coffee table
PAG. 302

PRODOTTI—PRODUCTS

Codice/Code Tipologia/Typology	Disegno/Drawing	Info
-----------------------------------	-----------------	------

721

Poltrona regista
Director's lounge chair
W77 - D64 - H79 (opened)
W20 - D64 - H119 (closed)
Kg 9,5

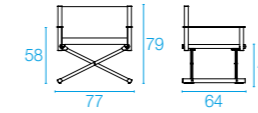

723

Poggiapiedi
Footstool
W75 - D46 - H40 (opened)
W11 - D46 - H82 (closed)
Kg 4,7



COLORI STRUTTURA/SCHIENALE/SEDUTA X COD. 721—FRAME/BACK/SEAT COLORS X COD. 721

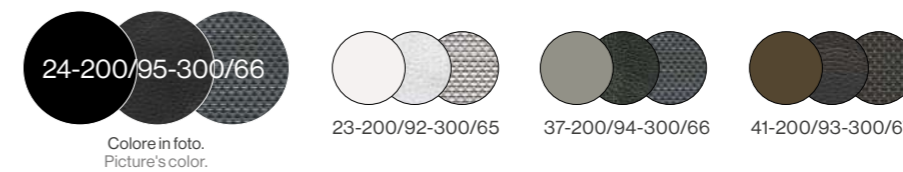

COLORI STRUTTURA/TELO X COD. 723—FRAME/CLOTH COLORS X COD. 723

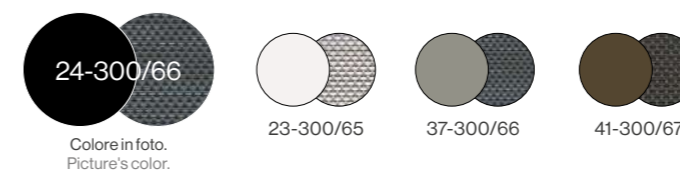

CUSCINI—CUSHIONS

Codice/Code Tipologia/Typology	Colori tessuto Fabric colors	Categoria tessuto Fabric category
C/721 Cuscino seduta Seat cushion x cod. 721 W64 - D64 - H8 Kg 0,9	Vedi pg. 258 Look at pg. 258	Tessuti Basic (Vedi riepilogo pg. 258) Tessuti Standard (Vedi riepilogo pg. 258)* Tessuti Exclusive (Vedi riepilogo pg. 258) Basic Fabrics (Look at pg. 258) Standard Fabrics (Look at pg. 258)* Exclusive Fabrics (Look at pg. 258)

*Cuscino visibile in foto 900/05 Marrone—Cushion in the picture 900/05 Brown

PLUS

- Design esclusivo e caratteristico.— Exclusive and distinctive design.
- Adatta a contesti marini e all'utilizzo su imbarcazioni.— Suitable to marine environment and boats.
- Estrema leggerezza e maneggevolezza (9,6 kg).— Extremely handy and light (9,6 kg).
- Schienale della poltrona in ecopelle che determina l'unicità del prodotto.
Eco-leather backrest that defines the uniqueness of this lounge armchair.
- Rivetti e viteria in acciaio inossidabile 316 adatto ad uso marino.
316 stainless steel rivets and screws, suitable to marine environments.
- Robustezza della struttura dovuta all'utilizzo di profili ed estrusi di alluminio ad alto spessore.
Frame strength thanks to aluminium extruded pipes and profiles.
- Prodotti pieghevoli, facilmente trasportabili e che possono essere riposti durante il periodo di non uso, occupando poco spazio nell'ambiente di rimessaggio.— Foldable, easy to move and small to store products.
- Dimensioni generose della poltrona che garantiscono elevato comfort.
Large sizes of the director's lounge chair that enhance comfort.
- Il cuscino della poltrona C/721 ha un'imbottitura sagomata più bassa sul lato posteriore che ne migliora il comfort in uso relax. Inoltre, sul lato inferiore è dotato di uno strato antiscivolo, è sfoderabile ed è disponibile in una vasta gamma di tessuti.
C/721 lounge armchair cushion has a moulded foam, lower in the rear side to increase comfort. Furthermore it has a non-slip layer on the lower side, it is cover removable and available in wide range of fabrics.
- Il telo del sedile realizzato in EMU-TEX è disponibile come accessorio di ricambio, così come lo schienale in eco-cuoio.
Seat cloth is in EMU-TEX and is available as replacement accessory, as well as the eco-leather backrest.



TESSUTI CUSCINI—CUSHION FABRICS C/721

Composizione/Categoria tessuti Composition/Fabrics category	Colori Colors
--	------------------

TESSUTI BASIC—BASIC FABRICS

Acrilico—Acrylic	700/4
	700/10
	700/13
	700/32
	700/34

TESSUTI STANDARD—STANDARD FABRICS

88% Acrilico, 12% Poliestere—88% Acrylic, 12% Polyester	900/02
	900/05
	900/07
	900/08
	900/09
Acrilico—Acrylic	900/18
	900/71
	900/75
	900/77

TESSUTI EXCLUSIVE—EXCLUSIVE FABRICS

CAT. E Visitare il nostro sito web www.emu.it —Visit our website www.emu.it	600/31
	600/32
	600/33
	600/34
	600/35
	600/36
	600/37
	600/38
	600/39
	600/40
CAT. D Visitare il nostro sito web www.emu.it —Visit our website www.emu.it	600/41
	600/42
	600/43
	600/48
CAT. C Visitare il nostro sito web www.emu.it —Visit our website www.emu.it	600/49
	600/27
CAT. B Visitare il nostro sito web www.emu.it —Visit our website www.emu.it	900/16
	600/07
	600/14
	600/16
	600/18
	600/11

CON TESSUTO CLIENTE—WITH CUSTOMER'S FABRIC

FABBISOGNO TESSUTO (cm)—FABRIC REQUIRED (cm)	C/721 132x100
--	---------------





Scansiona e scopri i progetti.
Scan and discover the projects.



729+C/729
Poltrona
Lounge chair



I cuscini dello schienale hanno piccole asole per il fissaggio ai perni in acciaio inossidabile presenti sulla struttura.
Backrest cushions have small holes to be fastened to the stainless-steel button on the frame.

* Cuscino visibile in foto 900/05 Marrone—Cushion in the picture 900/05 Brown

730+2xC/729
Divano 2 posti
2-Seater sofa



La pratica zip che unisce i cuscini sedile e schienale garantisce grande comfort.
The handy zip between seat and backrest cushions allows a great comfort.

* Cuscino visibile in foto 900/05 Marrone—Cushion in the picture 900/05 Brown

731+3xC/729
Divano 3 posti
3-Seater sofa



Struttura in profili di alluminio. Schienale e braccioli in eco-cuoio per esterni.
Frame in aluminium profiles. Backrest and armrests in eco-leather for outdoor use.

* Cuscino visibile in foto 900/05 Marrone—Cushion in the picture 900/05 Brown

ALTRI PRODOTTI IN COLLEZIONE—OTHER COLLECTION'S PRODUCTS

260



TERRAMARE
Cod. 732+735P
Tavolo basso piccolo
Small coffee table
PAG. 302



TERRAMARE
Cod. 733+736P
Tavolo basso medio
Medium coffee table
PAG. 302



TERRAMARE
Cod. 726
Tavolo smart
Smart table
PAG. 218

PRODOTTI—PRODUCTS

Codice/Code Tipologia/Typology	Disegno/Drawing	Info	TEST
729 Struttura poltrona Lounge chair frame W94 - D86 - H72 Kg 13,6			EN581-1/EN581-2
730 Struttura divano a 2 posti 2-Seater sofa frame W175 - D86 - H72 Kg 18,5			EN581-1/EN581-2
731 Struttura divano a 3 posti 3-Seater sofa frame W257 - 86 - H72 Kg 24,1			EN581-1/EN581-2

COLORI STRUTTURA/BRACCIOLI—FRAME/ARMRESTS COLORS

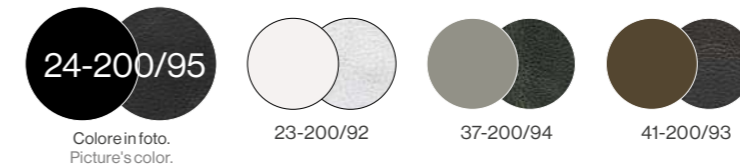

CUSCINI—CUSHIONS

Codice/Code Tipologia/Typology	Colori tessuto Fabric colors	Categoria tessuto Fabric category
C/729 Cuscino seduta e schienale Seat and back cushion x cod.729, 730, 731 W95 - D95 - H25 W90 - D50 - H25 Kg 6,7		Vedi pg. 262 Look at pg. 262 Tessuti Basic (Vedi riepilogo pg. 262) Tessuti Standard (Vedi riepilogo pg. 262)* Tessuti Exclusive (Vedi riepilogo pg. 262) Basic Fabrics (Look at pg. 262) Standard Fabrics (Look at pg. 262)* Exclusive Fabrics (Look at pg. 262)
C/701 Cuscino decorativo—Decorative cushion x cod.729, 730, 731 W40 - D40 - H15 Kg 0,7		Vedi pg. 369 Look at pg. 369 Tessuti Basic (Vedi riepilogo pg. 369) Tessuti Standard (Vedi riepilogo pg. 369) Tessuti Exclusive (Vedi riepilogo pg. 369) Basic Fabrics (Look at pg. 369) Standard Fabrics (Look at pg. 369) Exclusive Fabrics (Look at pg. 369)
C/705 Cuscino decorativo—Decorative cushion x cod.729, 730, 731 W45 - D35 - H15 Kg 0,7		
C/706 Cuscino decorativo—Decorative cushion x cod.729, 730, 731 W60 - D40 - H20 Kg 0,9		
FC/729 Cover x cod. 729		
FC/730 Cover x cod. 730		
FC/731 Cover x cod. 731		

PLUS

- Giunti in pressofusione di alluminio di grande finitura e ricercatezza estetica.
Elegant finishing and aesthetic refinement of die-cast aluminium joints.
- Imbottitura interna in fiocchi di poliestere, poliuretano espanso e memory foam con fodera impermeabile.
Polyester wads, expanded polyurethane and memory foam inner padding with waterproof lining.
- Fodera interna dei cuscini impermeabile per un migliore drenaggio dell'acqua.
Water-proof inner lining of the cushions for a better water drainage.

261



TESSUTI CUSCINI—CUSHION FABRICS C/729

Composizione/Categoria tessuti Composition/Fabrics category	Colori Colors
--	------------------

TESSUTI BASIC—BASIC FABRICS

Acrilico—Acrylic	700/4
	700/10
	700/13
	700/32
	700/34

TESSUTI STANDARD—STANDARD FABRICS

88% Acrilico, 12% Poliestere—88% Acrylic, 12% Polyester	900/02
	900/05
	900/07
	900/08
	900/09
Acrilico—Acrylic	900/18
	900/71
	900/75
	900/77

TESSUTI EXCLUSIVE—EXCLUSIVE FABRICS

CAT. E Visitare il nostro sito web www.emu.it —Visit our website www.emu.it	600/31
	600/32
	600/33
	600/34
	600/35
	600/36
	600/37
	600/38
	600/39
	600/40
CAT. D Visitare il nostro sito web www.emu.it —Visit our website www.emu.it	600/41
	600/42
	600/43
	600/48
CAT. C Visitare il nostro sito web www.emu.it —Visit our website www.emu.it	600/49
	600/27
CAT. B Visitare il nostro sito web www.emu.it —Visit our website www.emu.it	900/16
	600/07
	600/14
	600/16
600/18	600/11

CON TESSUTO CLIENTE—WITH CUSTOMER'S FABRIC

FABBISOGNO TESSUTO (cm)—FABRIC REQUIRED (cm)	C/729 132x360
--	---------------





Scansiona e scopri i progetti.
Scan and discover the projects.



6055+C/6055
Divano 1 posto Teak
con cuscini
1-Seater Teak sofa with
cushions



* Cuscino visibile in foto 900/77 Grigio—Cushion in the picture 900/77 Grey

6056+C/6056+C/6057
Divano 2 posti Teak
con cuscini
2-Seater Teak
sofa with cushions



* Cuscino visibile in foto 900/77 Grigio—Cushion in the picture 900/77 Grey

6057+C/6056+C/6057+C/6047
Divano 3 posti Teak con cuscini
3-Seater Teak sofa with cushions



* Cuscino visibile in foto 900/77 Grigio—Cushion in the picture 900/77 Grey



Bracciolo in teak massello FSC®
con venature e colori che ne
determinano l'unicità.
Solid FSC® teak armrest featured
by unique veining effect and
color.



Tutte le strutture di divani sono
dotate di piedini regolabili per
adattare la planarità su qualsiasi
suolo.
Every sofa has adjustable feet to
make the surface even.

PRODOTTI—PRODUCTS

Codice/Code Tipologia/Typology	Disegno/Drawing	Info
6055 Struttura divano 1 posto Teak 1-Seater Teak sofa frame W101 - D86 - H78 Kg 18,8		
6056 Struttura divano 2 posti Teak 2-Seater Teak sofa frame W176 - D86 - H78 Kg 29,4		
6057 Struttura divano 3 posti Teak 3-Seater Teak sofa frame W241,5 - 86 - H78 Kg 38,9		

COLORI STRUTTURA/BRACCIOLI—FRAME/ARMRESTS COLORS

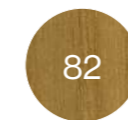

82
Colore in foto.
Picture's color.

CUSCINI—CUSHIONS

Codice/Code Tipologia/Typology	Colori tessuto Fabric colors	Categoria tessuto Fabric category
C/6055 Cuscino seduta e schienale Seat and back cushion x cod.6055 W83/65 - D82 - H15 W72 - D42 - H15 Kg 5,5		Vedi pg. 268 Look at pg. 268 Tessuti Basic (Vedi riepilogo pg. 268) Tessuti Standard (Vedi riepilogo pg. 268)* Tessuti Exclusive (Vedi riepilogo pg. 268) Basic Fabrics (Look at pg. 268) Standard Fabrics (Look at pg. 268)* Exclusive Fabrics (Look at pg. 268)
C/6056 Cuscino seduta e schienale destro Dx seat and back cushion x cod.6056, 6057 W78/72 - D82 - H15 W72 - D42 - H15 Kg 4,7		
C/6057 Cuscino seduta e schienale destro Dx seat and back cushion x cod.6056, 6057 W78/72 - D82 - H15 W72 - D42 - H15 Kg 4,7		
C/6047 Cuscino seduta e schienale centrale Middle seat and back cushion x cod.6057 W68/82 - D82 - H15 W68 - D42 - H15 Kg 4,3		

PLUS

- Gli arredi lounge completano la collezione e permettono di vestire destinazioni d'uso quali portici, patii, bordi piscina nonché ambienti marini con un'offerta variegata e segmentata.
Lounge products complete the collection and allow to furnish several environments as porches, patios, poolsides and marine environments with a segmented and various range.
- Le componenti in teak (ad esempio le singole stecche del sedile, il bracciolo) sono in teak massello ossia sono modellate da un unico pezzo di legno e non da listelli incollati; queste rende i prodotti più affidabili, di maggior pregio e qualità.— Teak elements (e.g. seat slats, armrest) are made by solid teak rather than by glued laths; this feature makes the products more reliable, valuable and high quality.
- Il teak, di livello A e certificato FSC®, quindi gestito responsabilmente, conferisce al prodotto un piacevole effetto tattile e visivo.—The quality degree is A and FSC® certified, so responsibly managed for a pleasant touch, look and feel.
- Ogni elemento in teak ha venature e colori che possono variare tra componente e componente. Questa caratteristica ne determina l'unicità.—Teak components have veining effect and color slightly different between each other and this difference defines the uniqueness of every single piece of furniture.
- Viteria in acciaio inossidabile a scomparsa che rafforza la tenuta del prodotto rispetto all'utilizzo della sola colla.
Stainless steel hidden screws enhance the strongness of the frame more than the only use of glue.

ALTRI PRODOTTI IN COLLEZIONE—OTHER COLLECTION'S PRODUCTS



TWINS
Cod. 6060
Tavolo basso
Coffee table
PAG. 304



TWINS
Cod. 6042
Poltrona Alu-Teak
Alu-Teak lounge chair
PAG. 134



TWINS
Cod. 6061
Tavolo quadrato 4 posti
4 seats square table
PAG. 182

TWINS

Design by Sebastian Herkner



Scansiona e scopri i progetti.
Scan and discover the projects.

6045+C/6055
Divano 1 posto Alu-Teak con cuscini
1-Seater Alu-Teak sofa with cushions



Sistema di aggancio del cuscino di seduta alla struttura tramite specifico componente per evitare lo scivolamento in uso, unito a strato antiscivolo. A specific component, in addition to a non-slip layer, allows to fast the cushion to the frame preventing the slipping.

* Cuscino visibile in foto 900/09 Salvia—Cushion in the picture 900/09 Sage

6046+C/6056+C/6057
Divano 2 posti Alu-Teak con cuscini
2-Seater Alu-Teak sofa with cushions



Fissaggio con fascia di tessuto e zip di chiusura del cuscino schienale alla struttura. Back cushion fastening system with rear fabric band and zip.

* Cuscino visibile in foto 900/09 Salvia—Cushion in the picture 900/09 Sage

6047+C/6056+C/6057+C/6047
Divano 3 posti Alu-Teak con cuscini
3-Seater Alu-Teak sofa with cushions



Fissaggio tra cuscino schienale e seduta tramite apposita zip di connessione, per un miglior comfort. Back and seat cushion fastening with a zip, for a better comfort.

* Cuscino visibile in foto 900/09 Salvia—Cushion in the picture 900/09 Sage

PRODOTTI—PRODUCTS



Codice/Code Tipologia/Typology	Disegno/Drawing	Info
6045 Struttura divano 1 posto Alu-Teak 1-Seater Alu-Teak sofa frame W101 - D86 - H78 Kg 14,0		
6046 Struttura divano 2 posti Alu-Teak 2-Seater Alu-Teak sofa frame W176 - D86 - H78 Kg 21,0		
6047 Struttura divano 3 posti Alu-Teak 3-Seater Alu-Teak sofa frame W241,5 - 86 - H78 Kg 28,9		

COLORI STRUTTURA/BRACCIOLI—FRAME/ARMRESTS COLORS

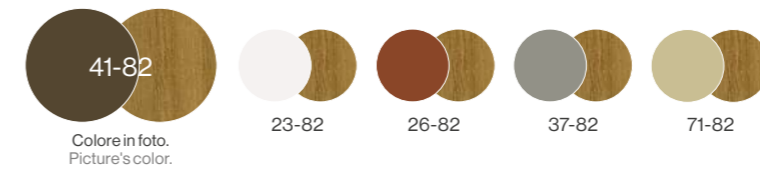

CUSCINI—CUSHIONS

Codice/Code Tipologia/Typology	Colori tessuto Fabric colors	Categoria tessuto Fabric category
C/6055 Cuscino seduta e schienale Seat and back cushion x cod.6045 W83/65 - D82 - H15 W72 - D42 - H15 Kg 5,5		Vedi pg. 268 Look at pg. 268 Tessuti Basic (Vedi riepilogo pg. 268) Tessuti Standard (Vedi riepilogo pg. 268)* Tessuti Exclusive (Vedi riepilogo pg. 268) Basic Fabrics (Look at pg. 268) Standard Fabrics (Look at pg. 268)* Exclusive Fabrics (Look at pg. 268)
C/6056 Cuscino seduta e schienale destro Dx seat and back cushion x cod.6046, 6047 W78/72 - D82 - H15 W72 - D42 - H15 Kg 4,7		
C/6057 Cuscino seduta e schienale destro Dx seat and back cushion x cod.6046, 6047 W78/72 - D82 - H15 W72 - D42 - H15 Kg 4,7		
C/6047 Cuscino seduta e schienale centrale Middle seat and back cushion x cod.6047 W68/82 - D82 - H15 W68 - D42 - H15 Kg 4,3		

PLUS

- I cuscini di sedile e di schienale sono sfoderabili; l'imbottitura interna è in resinato di due diverse densità, lo strato superiore più soffice e quello inferiore più denso, per aumentare il comfort in uso. La cover dell'imbottitura interna è impermeabile.—The cushions have a completely removable cover; the inner foam has a double density, the above one softer and the lower one thicker, to increase the comfort in use. Its lining is water proof.
- Disponibile una vasta gamma di tessuti.— Available in a wide range of fabrics.
- I cuscini seduta hanno un particolare sistema di fissaggio al sedile che ne limita lo spostamento; c'è inoltre, sul lato inferiore, uno strato antiscivolo per limitare al minimo l'effetto di slittamento fuori dalla seduta. Seat cushions have an underneath fixing element that prevents the slipping, together with a non-slip layer that avoid the cushion swing out the seat.
- Braccioli resistenti a eventuali sollecitazioni di peso tipiche di un uso improprio. The armrests are resistant to occasional weight stresses due to an incorrect use.
- I braccioli possono essere sostituiti e gestiti come pezzi di ricambio. The armrests could be replaced as a replacement accessory element.



Scansiona e scopri
i progetti.
Scan and discover
the projects.

TESSUTI CUSCINI—CUSHION FABRICS

C/6047 - C/6051 - C/6052 - C/6053 - C/6055 - C/6056 - C/6057

Composizione/Categoria tessuti Composition/Fabrics category	Colori Colors
TESSUTI BASIC—BASIC FABRICS	
Acrilico—Acrylic	700/4
	700/10
	700/13
	700/32
	700/34
TESSUTI STANDARD—STANDARD FABRICS	
88% Acrilico, 12% Poliestere—88% Acrylic, 12% Polyester	900/02
	900/05
	900/07
	900/08
	900/09
Acrilico—Acrylic	900/18
	900/71
	900/75
	900/77
	TESSUTI EXCLUSIVE—EXCLUSIVE FABRICS
CAT. E Visitare il nostro sito web www.emu.it —Visit our website www.emu.it	600/31
	600/32
	600/33
	600/34
	600/35
	600/36
	600/37
	600/38
	600/39
	600/40
CAT. D Visitare il nostro sito web www.emu.it —Visit our website www.emu.it	600/41
	600/42
	600/43
	600/48
	600/49
	600/27
	900/16
	600/07
	600/14
	600/16
CAT. C Visitare il nostro sito web www.emu.it —Visit our website www.emu.it	600/18
	600/11
	600/11
CON TESSUTO CLIENTE—WITH CUSTOMER'S FABRIC	
FABBISOGNO TESSUTO (cm)—FABRIC REQUIRED (cm)	C/6047 132x270, C/6051 132x42, C/6052 132x82, C/6053 132x95, C/6055 132x315, C/6056 132x320, C/6057 132x320

CUSCINI E ACCESSORI—CUSHIONS AND ACCESSORIES

Codice/Code Tipologia/Typology	Colori tessuto Fabric colors	Categoria tessuto Fabric category
C/701 Cuscino decorativo—Decorative cushion x cod.6045, 6046, 6047, 6055, 6056, 6057 W40 - D40 - H15 Kg 0,7		Vedi pg. 369 Look at pg. 369
C/705 Cuscino decorativo—Decorative cushion x cod.6045, 6046, 6047, 6055, 6056, 6057 W45 - D35 - H15 Kg 0,7		
C/706 Cuscino decorativo—Decorative cushion x cod.6045, 6046, 6047, 6055, 6056, 6057 W60 - D40 - H20 Kg 0,9		
FC/729 Cover x cod. 6045, 6055		
FC/730 Cover x cod. 6046, 6056		
FC/6047 Cover x cod. 6047, 6057		

DIVANI NELLE ALTRE COLLEZIONI

SOFAS IN THE OTHER COLLECTIONS

ATHENA

Design by EMU D&S Lab

3417

Divano 2 posti
2-Seater sofa
PAG. 30



SHINE

Design by Arik Levy

260

Divano 2 posti
2-Seater sofa
PAG. 110



CAROUSEL

Design by Sebastian Herkner

1219

Divano Alu-corda intreccio fitto
Alu-thick twist rope sofa
PAG. 40



STAR

Design by EMU D&S Lab

166

Divano 2 posti
2-Seater sofa
PAG. 124



COMO

Design by Angeletti—Ruzza

1205

Divano 2 posti
2-Seater sofa
PAG. 56



YARD

Design by Stefan Diez

531

Divano 2 posti
2-Seater sofa
PAG. 142



DARWIN

Design by Lucidi—Pevere

527

Divano 2 posti
2-Seater sofa
PAG. 64





RE-TROUVÉ—ELLE CAFÉ—JAPAN



ROUND+PIAZZETTA—MASSERIA BAGNARA RESORT & SPA—ITALY

EMU NEL MONDO EMU IN THE WORLD



ROUND—SAUNA LÖYLY—FINLAND

TAVOLI BASSI COFFEE TABLES

I tavoli bassi EMU sono progettati per essere facilmente abbinabili ai più svariati stili di poltrone, divani e lettini. Particolarmente performanti in ambienti esterni, questi coffee table sono disponibili in differenti misure e altezze. I piani, resistenti all'usura, alle macchie e agli agenti atmosferici, sono disponibili in diversi materiali e combinazioni colore.

EMU coffee tables are designed to match a wide variety of armchairs, sofas and sunbeds. These coffee tables are available in different heights and sizes and are particularly suitable to outdoor spaces. The hard-wearing, stain and weather resistant tops are available in various materials and color combinations.



INDEX

276	ANGEL	●
278	ATHENA	●
280	CABLA	●
282	CANNOLE	●
284	CAROUSEL	●
286	COLLIER	●
288	COMO	●
290	DARWIN	●
292	HEAVEN	●
294	HOLLY	●
294	IVY	●
296	RIO R50	●
298	ROUND	●
300	SHINE	● ●
300	TAMI	● ●
302	TERRAMARE	●
304	TWINS	●
306	YARD	●

LEGENDA—LEGEND
● Acciaio—Steel
● Alluminio—Aluminium
● Legno—Wood



Scansiona e scopri i progetti.
Scan and discover the projects.

9055
Tavolo basso
Coffee table



Sezione caratteristica del giunto di struttura.
Characteristic profile of the structural joint.

PRODOTTI—PRODUCTS



Codice/Code Tipologia/Typology	Disegno/Drawing	Info
-----------------------------------	-----------------	------

9055*

Tavolo basso
Coffee table
W90 - D90 - H30-45
Kg 14,0

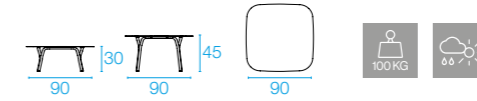

* Tavolo basso con 2 set di gambe diversi presenti nell'imballo e utilizzabili in base alle necessità: uno con altezza 30 cm e una con altezza 45 cm.—Coffee table with 2 different sets of legs in the pack usable as needed: one 30 cm height and one 45 cm height.

COLORI STRUTTURA—FRAME COLORS

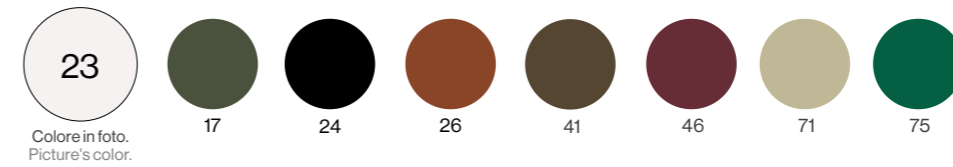

PLUS

- Piani dagli angoli sagomati per una maggiore fruibilità e finitura estetica più elevata.
Tops with shaped corners for greater usability and higher aesthetic finish.
- Disponibilità nell'imballo di due coppie di gambe di diversa altezza al fine di offrire la possibilità di personalizzare l'altezza del tavolo stesso.—Availability in the packaging of two pairs of legs of different heights in order to offer the possibility of customizing the height of the table itself.



Scansiona e scopri i progetti.
Scan and discover the projects.

3418
Tavolo basso
Coffee table



Piano in lamiera finto intreccio zincata a caldo.
Top in hot-dip zincated simulated woven wire mesh.

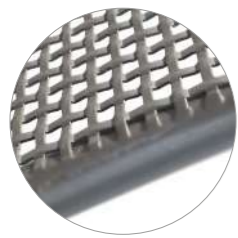

Saldatura a proiezione per una maggiore precisione estetica.
Spot welding for greater aesthetic precision.

PRODOTTI—PRODUCTS



Codice/Code Tipologia/Typology	Disegno/Drawing	Info
-----------------------------------	-----------------	------

3418

Tavolo basso
Coffee table
W100 - D60 - H40
Kg 10,5

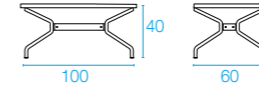

COLORI STRUTTURA—FRAME COLORS

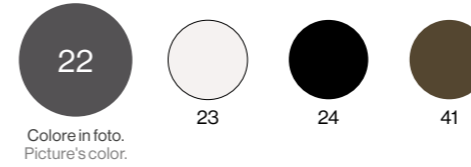



Scansiona e scopri i progetti.
Scan and discover the projects.

5047
Tavolo basso
Coffee table



5048
Tavolo basso
Coffee table



5049
Tavolo basso
Coffee table



5050
Tavolo basso
Coffee table



Sottopiedi regolabili per una migliore stabilità su superfici irregolari.
Adjustable feet for a higher stability on uneven surfaces.

PRODOTTI—PRODUCTS

Codice/Code Tipologia/Typology	Disegno/Drawing	Info
-----------------------------------	-----------------	------

5047
Tavolo basso
Coffee table
W98,5 - D98,5 - H30
Kg 17,8

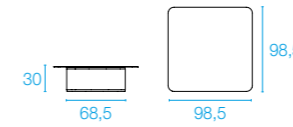

5048
Tavolo basso
Coffee table
ø98,5 - H30
Kg 15,6

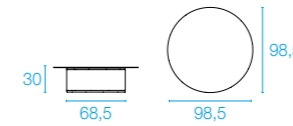

5049
Tavolo basso
Coffee table
W58 - D58 - H44,5
Kg 8,9

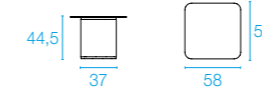

5050
Tavolo basso
Coffee table
ø58 - H44,5
Kg 8,3

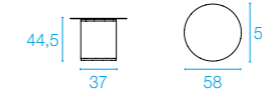

COLORI STRUTTURA—FRAME COLORS

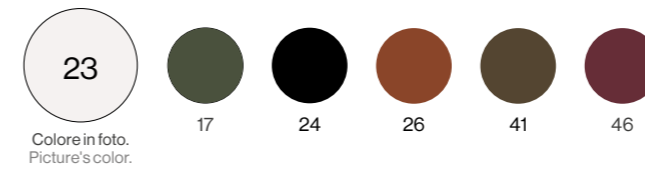

PLUS

• Acciaio inossidabile come materiale principale, a contesti marini e all'utilizzo su imbarcazioni.
The main material is stainless steel, suitable to marine environment and boats.

CANNOLÈ

Design by Cristell—Gargano



Scansiona e scopri i progetti.
Scan and discover the projects.

1087
Tavolo basso grande
Big coffee table



Struttura e tondini in acciaio zincato a caldo.
Frame and bars in hot-dip zincated steel.

1088
Tavolo basso piccolo
Small coffee table



Piano in lamiera prezincata di acciaio.
Top in hot-dip zincated sheet steel.

PRODOTTI—PRODUCTS



Codice/Code Tipologia/Typology	Disegno/Drawing	Info
-----------------------------------	-----------------	------

1087
Tavolo basso grande
Big coffee table
ø105 - H45
Kg 16,8

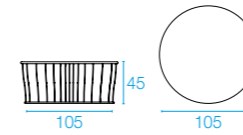

1088
Tavolo basso piccolo
Small coffee table
ø60 - H55
Kg 7,6

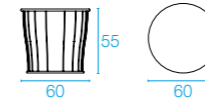

COLORI STRUTTURA—FRAME COLORS

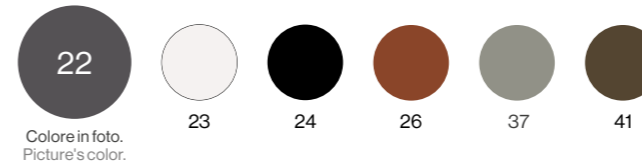

CAROUSEL

Design by Sebastian Herkner



Scansiona e scopri i progetti.
Scan and discover the projects.

1223

Tavolo basso quadrato
Alu-corda intreccio fitto
Alu-thick twist rope
square coffee table



Rivestimento della base con intreccio in corda in polipropilene.
Base covering with thick twist made of polypropylene rope.

1224

Tavolo basso rettangolare
Alu-corda intreccio fitto
Alu-thick twist rope
rectangular coffee table



Sottopiedi regolabili.
Adjustable feet.

PRODOTTI—PRODUCTS



Codice/Code Tipologia/Typology	Disegno/Drawing	Info
-----------------------------------	-----------------	------

1223

Tavolo basso quadrato
Alu-corda intreccio fitto
Alu-thick twist rope
square coffee table
W49 - D49 - H44,5
Kg 6,3

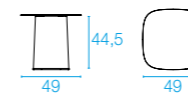

1224

Tavolo basso rettangolare
Alu-corda intreccio fitto
Alu-thick twist rope
rectangular coffee table
W110 - D80 - H30
Kg 14,6

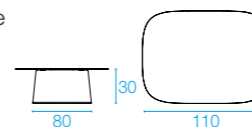

COLORI PIANO/STRUTTURA—TOP/FRAME COLORS

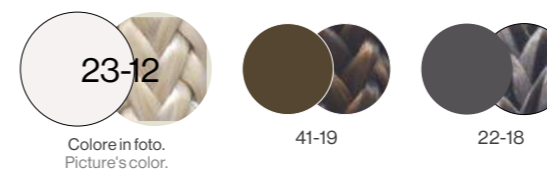

PLUS

- Piano realizzato in lega di alluminio con angoli arrotondati.
Top made of aluminum alloy with rounded corners.
- Base in tondino di acciaio cataforizzato su cui è costruito l'intreccio, peculiare caratteristica estetica.
Its combination between the rope weaving with the cataphorised steel bar is the distinctive aesthetic feature.
- Due differenti misure e altezze che diventano complementari.
Tables available in two different sizes and heights that become complementary.



Scansiona e scopri i progetti.
Scan and discover the projects.

1356+1340
Tavolo basso con piano in lamiera
Coffee table with steel sheet top



Base circolare con sottopiedi regolabili per una maggiore stabilità e per adattarsi alle irregolarità del terreno.
Round base with adjustable feet for greater stability and to adapt to uneven floor.

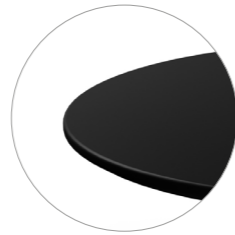

Piano in lamiera piena zincata a caldo con bordo piegato per un maggiore comfort di appoggio in uso.
Hot-dip zincated steel sheet top with folded edge for greater comfort in use.

1356+1341
Tavolo basso con piano in gres
Coffee table with gres top



Finitura in gres porcellanato come alternativa materica di piano.
Porcelain stoneware for a textured top choice.

PRODOTTI—PRODUCTS

Codice/Code Tipologia/Typology	Disegno/Drawing	Info
-----------------------------------	-----------------	------

1356

Struttura tavolo basso
Round coffee table frame
ø66 - H29
x cod. 1340, 1341
Kg 4,6

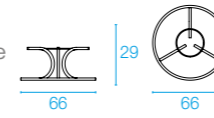

1340

Piano in lamiera per tavolo basso
Steel sheet coffee table top
x cod. 1356
ø80 - H3
Kg 6,6

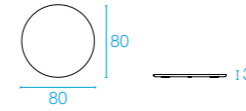

1341

Piano in gres per tavolo basso
Gres coffee table top
x cod. 1356
ø77 - H1,2
Kg 13,0

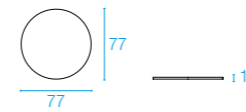

COLORI STRUTTURA X COD. 1356, 1340—FRAME COLORS X COD. 1356, 1340

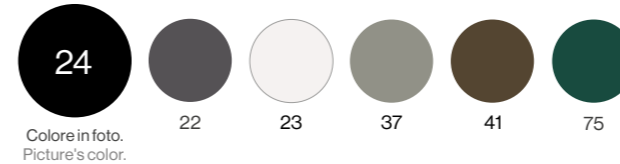

COLORI PIANO X COD. 1341—TOP COLORS X COD. 1341

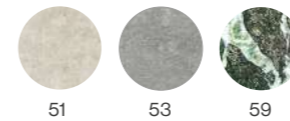

PLUS

- Possibilità di scelta tra piano in metallo e piano in gres.
Possibility to choose between metal top and stoneware top.
- I piani sono rinforzati con un tubolare che funge anche da unione alla struttura.
The tops are reinforced with a tubular which also acts as a connection to the frame.
- Viterie in acciaio inox.—Stainless steel screws.



Scansiona e scopri i progetti.
Scan and discover the projects.

1208
Tavolo basso
Coffee table



PRODOTTI—PRODUCTS



Codice/Code Tipologia/Typology	Disegno/Drawing	Info
-----------------------------------	-----------------	------

1208

Tavolo basso
Coffee table
ø60 - H47
Kg 6,5

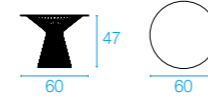

COLORI STRUTTURA—FRAME COLORS

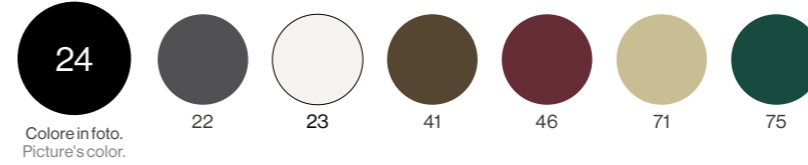

Colore in foto.
Picture's color.

PLUS

- Sinuoso reticolo di tondini zincati crea forme classiche e affascinanti. La struttura in tondini è realizzata tramite saldatura a proiezione.— Sinuous grid of zincated bars that create classic and fascinating shapes. The bars frame is manufactured by spot welding.
- Piano in lamiera zincata a caldo.— Hot-dip zincated sheet top.



Scansiona e scopri i progetti.
Scan and discover the projects.

526
Tavolo basso
Coffee table



Piano in lamiera zincata a caldo con bordo arrotondato tramite imbutitura.
Hot-dip zincated sheet top with moulded rounded edge.

878
Tavolo tondo abbattibile h60 2 posti
2 seats h60 collapsible round table



879
Tavolo quadrato abbattibile h60 2 posti
2 seats h60 collapsible square table



PRODOTTI—PRODUCTS



Codice/Code Tipologia/Typology	Disegno/Drawing	Info
-----------------------------------	-----------------	------

526 Tavolo basso Coffee table W70 - D70 - H40 Kg 8,2		 EN581-1/EN581-3
---	--	---------------------

878 Tavolo tondo abbattibile h60 2 posti 2 seats h60 collapsible round table ø60 - H60 Kg 11,5		
---	--	--

879 Tavolo quadrato abbattibile h60 2 posti 2 seats h60 collapsible square table W70 - D70 - H60 Kg 13,9		
--	--	--

COLORI STRUTTURA X COD. 526—FRAME COLORS X COD. 526

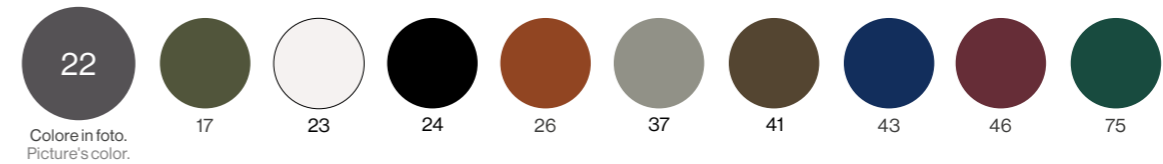

COLORI STRUTTURA X COD. 878, 879—FRAME COLORS X COD. 878, 879

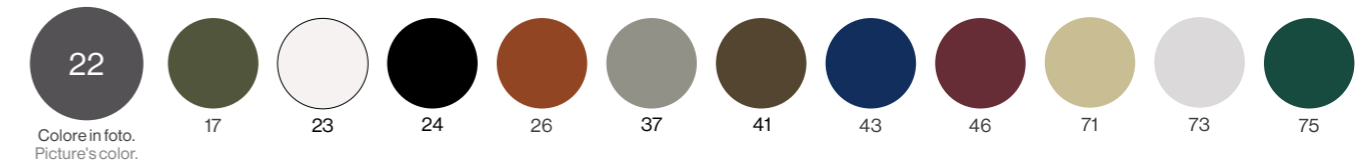



Scansiona e scopri i progetti.
Scan and discover the projects.

495+495/V
Tavolo basso
Coffee table



496+494/V
Tavolo basso
Coffee table

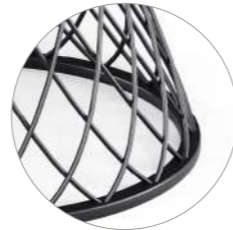

Sinuoso reticolo di tondini zincati crea forme classiche e affascinanti. La struttura in tondini è realizzata tramite saldatura a proiezione.
Sinuous grid of hot-dip zincated bars that create classic and fascinating shapes. The bars frame is manufactured by spot welding.

PRODOTTI—PRODUCTS



Codice/Code Tipologia/Typology	Disegno/Drawing	Info
-----------------------------------	-----------------	------

495

Struttura pouf/tavolo basso
Pouf/coffee table frame
x cod. 495/S, 495/V
ø45 - H46
Kg 3,6

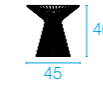

496

Struttura tavolo basso
Small coffee table frame
x cod. 494/V
ø110 - H38
Kg 7,7

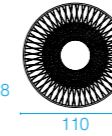

COLORI STRUTTURA—FRAME COLORS

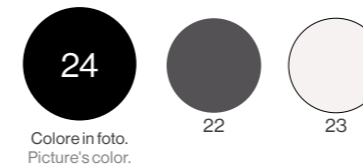

PIANI IN CRISTALLO/CUSCINO—GLASS TOPS/CUSHION

Codice/Code Tipologia/Typology	Colori Colors	Categoria tessuto Fabric category
495/S Cuscino seduta imbottito polipropilene Polypropylene padded seat cushion x cod. 495 ø45 - H1 Kg 1,8		900/71 900/75 900/77 Tessuti Standard Standard Fabrics
494/V Piano in cristallo per tavolo 4/6 posti Glass top for 4/6 seats table x cod. 494, 496 ø120 - H0,8 Kg 22,5		00 83*
495/V Piano in cristallo Glass top x cod. 495 ø50 - H0,6 Kg 2,9		00 83*

* Piano in vetro visibile in foto 83 Fumé—Glass in the picture 83 Smoky grey

HOLLY

Design by EMU D&S Lab



Scansiona e scopri i progetti.
Scan and discover the projects.

196
Tavolo basso
Coffee table



PRODOTTI—PRODUCTS

Codice/Code Tipologia/Typology	Disegno/Drawing	Info
-----------------------------------	-----------------	------

196
Tavolo basso
Coffee table
W44 - D45 - H43
Kg 2,9

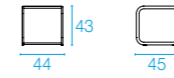

COLORI STRUTTURA—FRAME COLORS

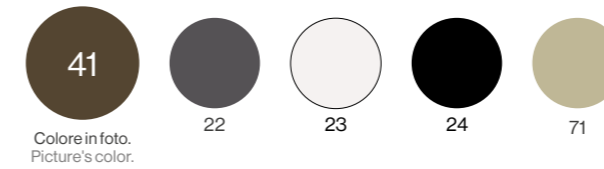

IVY

Design by Paola Navone



Scansiona e scopri i progetti.
Scan and discover the projects.

589
Tavolo basso
Coffee table



PRODOTTI—PRODUCTS

Codice/Code Tipologia/Typology	Disegno/Drawing	Info
-----------------------------------	-----------------	------

589
Tavolo basso
Coffee table
W135 - D74 - H30
Kg 14,2

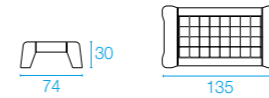

COLORI STRUTTURA—FRAME COLORS

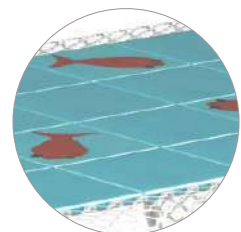
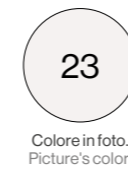

Optional: kit di mattonelle in terracotta di Deruta dipinte a mano. Possibilità di scelta tra due varianti: Pesce (6 mattonelle con pesce e 26 mattonelle turchesi) e Scarabeo (6 mattonelle con scarabeo e 26 mattonelle bianche). Le mattonelle sono appoggiate sul piano di lamiera e il cliente può comporre il disegno a suo piacimento.
Optional for low table: kit of hand-painted Deruta terracotta tiles. You can choose between two variants: Fish (6 tiles with fish and 26 turquoise tiles) and Beetle (6 tiles with beetle and 26 white tiles). The tiles stand on the sheet metal surface and the customer can compose the design as desired.

Codice/Code Tipologia/Typology	Colori Colors
-----------------------------------	------------------

590
Mattonelle con pesce o scarabeo
Tiles with fish or scrabble
x cod. 589
W12 - D12 - H1,5 Kg 0,37 (una—one)



PLUS
• Tavolo con piano in lamiera zincata a caldo.
Table top made of hot-dip zincated sheet.

RIO R50

Design by Cristell—Gargano



Scansiona e scopri i progetti.
Scan and discover the projects.

797

Tavolo basso
Coffee table



PRODOTTI—PRODUCTS



Codice/Code Tipologia/Typology	Disegno/Drawing	Info
-----------------------------------	-----------------	------

797

Tavolo basso
Coffee table
W104 - D104 - H42
Kg 9,8

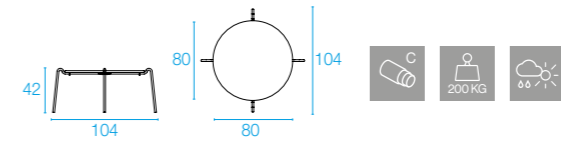

COLORI STRUTTURA—FRAME COLORS

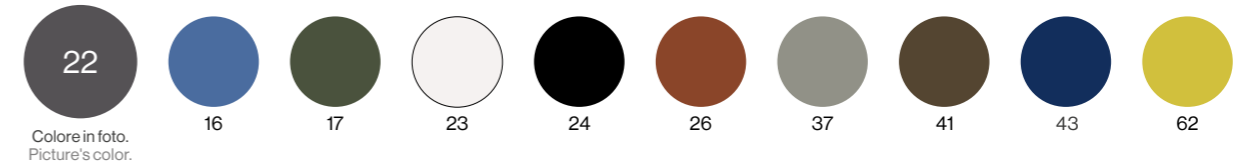

PLUS

- Piano con bordo stonato in lamiera zincata a caldo.—Round edged top in hot-dip zincated sheet.
- Piegatura del tubo che riproduce una R segno caratteristico della collezione.
"R" bended tube as distinctive sign of the collection.
- Gambe in acciaio Asform con elevata capacità di resistenza meccanica.
Asform steel legs with high static load resistance.

ROUND

Design by Christophe Pillet



Scansiona e scopri i progetti.
Scan and discover the projects.

482
Tavolo snack
Snack table



483
Tavolo basso
Coffee table



477
Tavolo basso
Coffee table



PRODOTTI—PRODUCTS



Codice/Code Tipologia/Typology	Disegno/Drawing	Info
-----------------------------------	-----------------	------

482
Tavolo snack
Snack table
W100 - D70 - H45
Kg 12,1

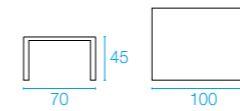

483
Tavolo basso
Coffee table
W45 - D45 - H42
Kg 4,5



477
Tavolo basso
Coffee table
W80 - D80 - H42
Kg 11,7

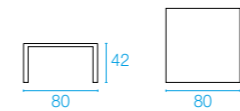

COLORI STRUTTURA—FRAME COLORS

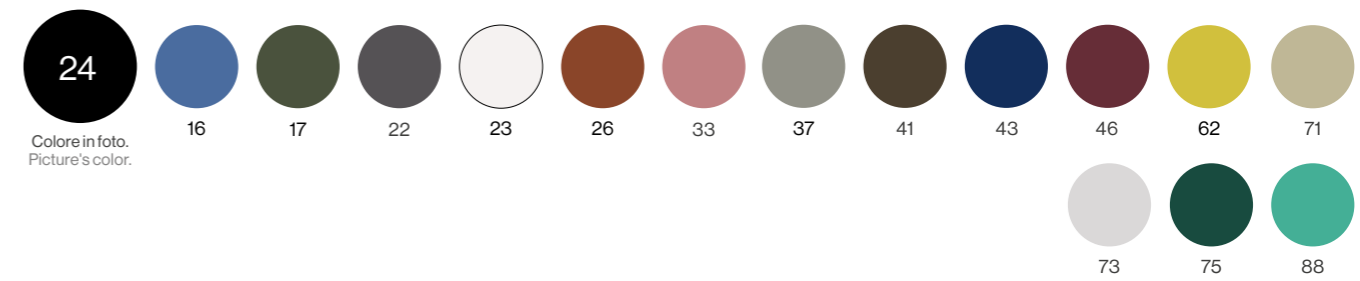

PLUS

- Piano in lamiera zincata a caldo.—Hot-dip zined sheet top.
- Cod. 482: altezza di 45 cm, maggiore rispetto al coffee table. Altezza adatta per condividere un aperitivo, uno snack o ancora per utilizzare un computer portatile stando rilassati sul divano.
Cod. 482: 45 cm high - higher than an usual coffee table. Ideal for sharing an appetizer, a snack or even to use a laptop relaxing on the couch.
- Piano autolivellante.—Self-levelling top.

SHINE

Design by Arik Levy



Scansiona e scopri i progetti.
Scan and discover the projects.

252
Tavolo basso
Coffee table



Piano in teak FSC®.
Teak FSC® top.

PRODOTTI—PRODUCTS

Codice/Code Tipologia/Typology	Disegno/Drawing	Info	TEST
-----------------------------------	-----------------	------	------

252
Tavolo basso
Coffee table
W79 - D79 - H40
Kg 8,2

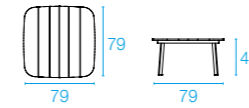

EN581-1/EN581-3



COLORI STRUTTURA/PIANO IN TEAK—FRAME/TEAK TOP COLORS



PLUS

• Profili in alluminio per una leggerezza strutturale ed estetica.
Aluminium profiles for an aesthetic and structural lightness.



TAMI

Design by Patrick Norguet



Scansiona e scopri i progetti.
Scan and discover the projects.

766
Tavolo basso
Coffee table

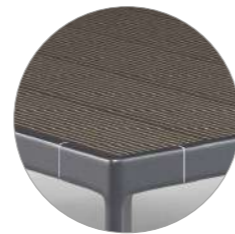

Doghe in WPC.
WPC slats.

767
Tavolo basso
Coffee table

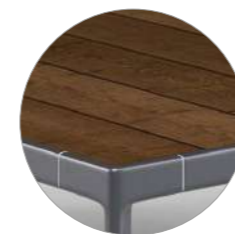

Doghe in bambù.
Bamboo slats.

PRODOTTI—PRODUCTS

Codice/Code Tipologia/Typology	Disegno/Drawing	Info
-----------------------------------	-----------------	------

766
Tavolo basso
Coffee table
W89 - D86 - H25
Kg 27,2 (WPC)/30,6 (Bamboo)

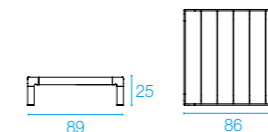

767
Tavolo basso
Coffee table
W132 - D57 - H42
Kg 27,6 (WPC)/31,6 (Bamboo)

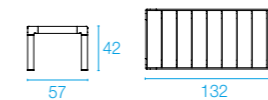

COLORI STRUTTURA/DOGHE—FRAME/SLATS COLORS

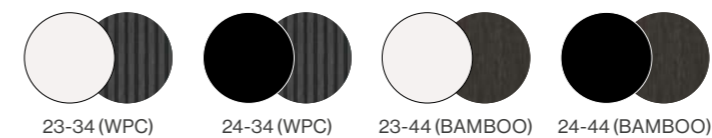

PLUS

• Giunti in pressofusione di alluminio.—Aluminium die-cast joints.



Scansiona e scopri i progetti.
Scan and discover the projects.



PRODOTTI—PRODUCTS

732+735P
Tavolo basso piccolo
Small coffee table



34 Basaltina



733+736P
Tavolo basso medio
Medium coffee table



35 Bianco statuario
35 Statuario white



734+737P
Tavolo basso grande
Big coffee table



36 Emperador



Codice/Code Tipologia/Typology	Disegno/Drawing	Info
-----------------------------------	-----------------	------

732+735P
Tavolo basso piccolo
Small coffee table
W48 - D48 - H40
Kg 3,1

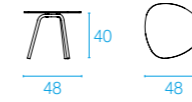

733+736P
Tavolo basso medio
Medium coffee table
W75 - D70 - H30
Kg 6,3

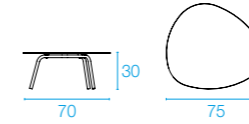

734+737P
Tavolo basso grande
Big coffee table
W108 - D64 - H35
Kg 8,4

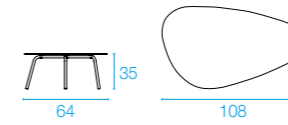

COLORI STRUTTURA/PIANO—FRAME/TOP COLORS

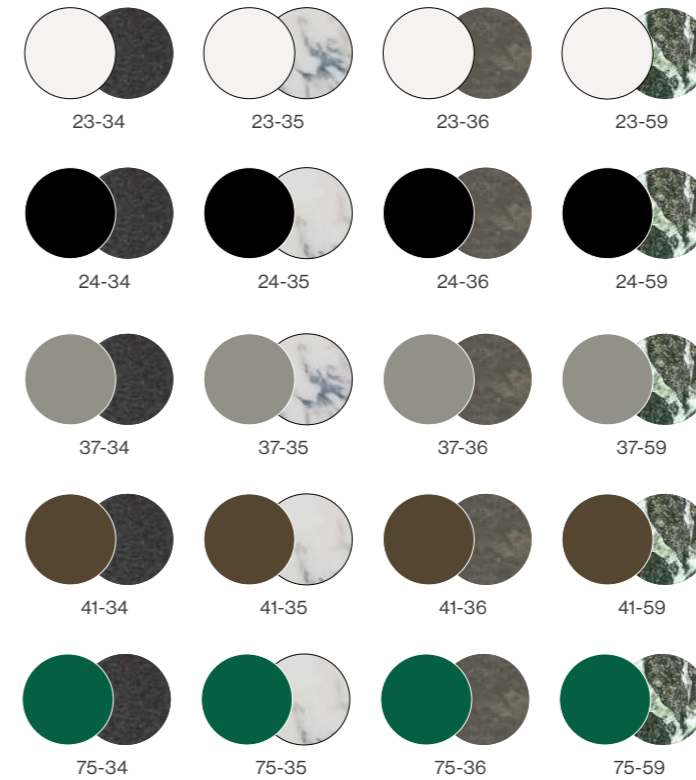

PLUS

- Possibilità di personalizzare e combinare i 3 colori dei piani con i 4 diversi colori della struttura.
Possibility to customize and combine 3 colors tops with 4 colors frames.
- Piano in gres porcellanato per una migliore resistenza all'usura, macchie e agenti atmosferici.
Porcelain stoneware top for higher resistance to wear, stains and atmospheric agents.



Scansiona e scopri i progetti.
Scan and discover the projects.

6060
Tavolo basso
Coffee table



Doghe in teak massello FSC® con venature e colori che ne determinano l'unicità.

Solid FSC® teak slats featured by unique veining effect and color.



Il bordo perimetrale incastona le doghe creando una superficie perfettamente piana dunque facilmente pulibile.

Perimeter profile finely frames top slats and creates an even surface easy to clean and to remove any leftover.



Codice/Code Tipologia/Typology	Disegno/Drawing	Info
-----------------------------------	-----------------	------

6060

Tavolo basso
Coffee table
W85 - D85 - H35
Kg 13,4



COLORI STRUTTURA/SEDUTA/BRACCIOLI—FRAME/SEAT/ARMRESTS COLORS

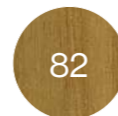

82
Colore in foto.
Picture's color.

PLUS

- Il teak, di livello A e certificato FSC®, quindi gestito responsabilmente, conferisce al prodotto un piacevole effetto tattile e visivo.

The quality degree is A and FSC® certified, so responsibly managed for a pleasant touch, look and feel.

- Il bordo perimetrale che incornicia finemente le doghe del piano ne definisce il design ricercato.

Questo coffee table mantiene così il raccordo con gli altri elementi della collezione Twins ma può essere trasversalmente combinato ad altre collezioni lounge.

Perimeter profile finely frames top slats and defines its elegant design. This coffee tables keep consistency to other Twins elements but can also also be combined to other multimaterial dining seat collections.

- Viterie in acciaio inossidabile nascoste per una migliore pulizia dei dettagli.

Stainless steel hidden screws for neat details.

- Adatto per utilizzo in ambienti marini e su imbarcazioni.— Suitable to marine environments and boats.



Scansiona e scopri i progetti.
Scan and discover the projects.

507
Tavolo basso
Coffee table



509
Tavolo basso
Coffee table



PRODOTTI—PRODUCTS



Codice/Code Tipologia/Typology	Disegno/Drawing	Info	TEST
-----------------------------------	-----------------	------	------

507 Tavolo basso Coffee table W60 - D60 - H40 Kg 4,0			EN581-1/EN581-3
--	--	--	-----------------

509 Tavolo basso Coffee table ø50 - H50 Kg 3,5			
--	--	--	--

COLORI STRUTTURA—FRAME COLORS

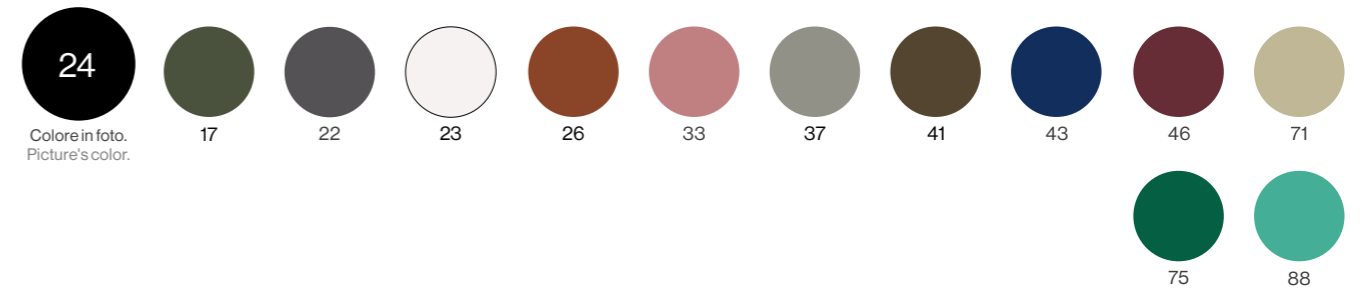

PLUS

- Tavolo leggero e maneggevole in lega di alluminio.— Light and handy table in aluminium alloy.
- Gambe smontabili. Imballo salvaspazio.— Assemblable legs. Flat pack.

EMU NEL MONDO EMU IN THE WORLD

SHINE+SHADE—CLUB MED EXCLUSIVE COLLECTION—ITALY

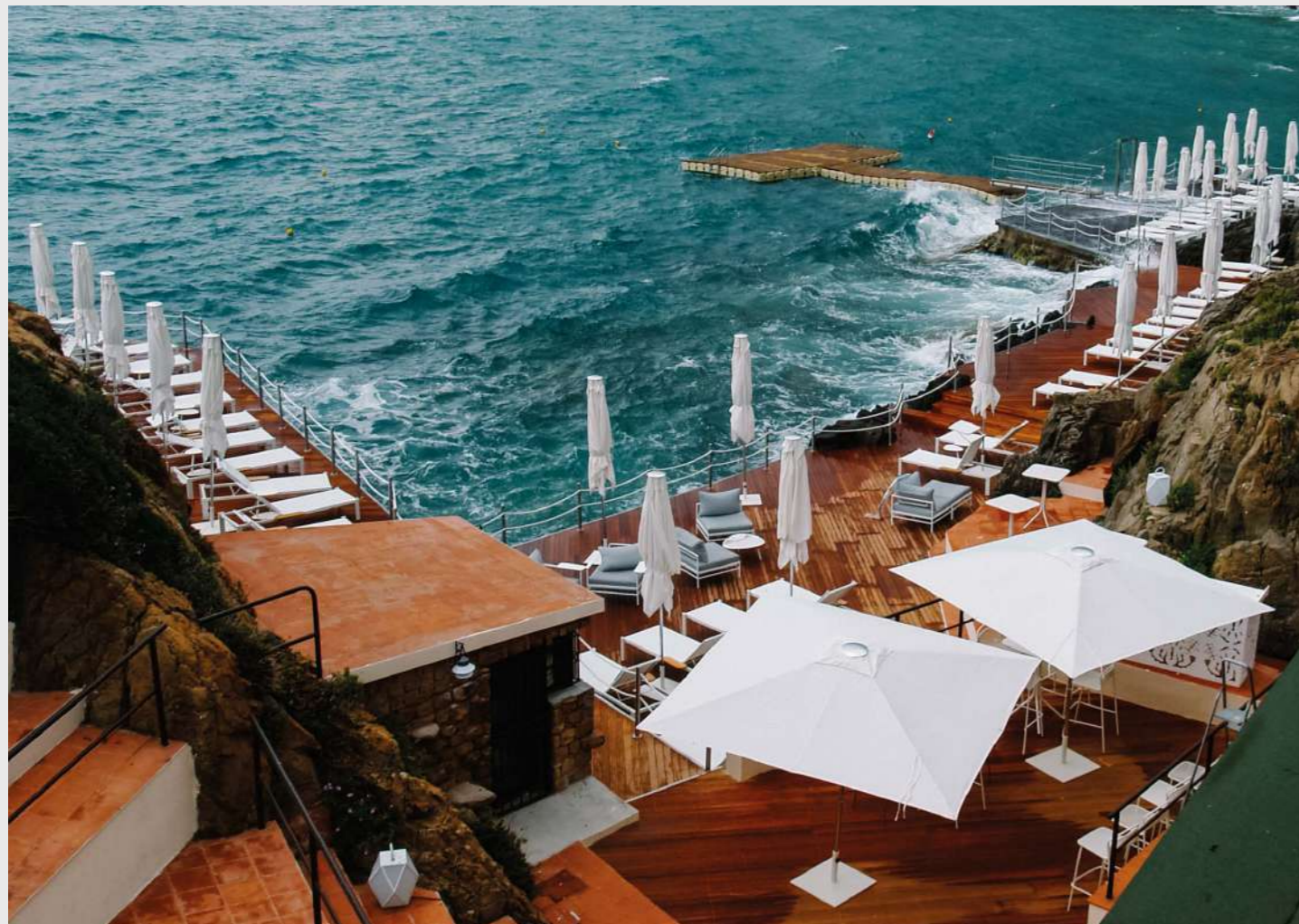

HOLLY—HARRISON URBY—USA



ROUND—CAIDOMINICI—ITALY



LETTINI E SDRAIO SUNBEDS AND DECK CHAIRS

Robusti, pratici, leggeri, confortevoli, impilabili e perfettamente resistenti agli agenti atmosferici. I lettini e le sdraio EMU sono dotati di semplici meccanismi con cui ottenere diverse inclinazioni degli schienali. Le sedute ergonomiche garantiscono sostegno e comodità. Ne completano la funzionalità alcuni optional: tetti parasole, reti e braccioli porta oggetti, poggiatesta, cuscini e ruote.

Sturdy, practical, light, comfortable, stackable and perfectly weather resistant, EMU sunbeds and deck chairs have user-friendly, reclining mechanisms to adjust the backrests. The ergonomic seats guarantee support and comfort. Optional accessories provide additional functions: sunbed roofs, storage nets and armrests, footrests, cushions and wheels.

INDEX

LEGENDA—LEGEND
● Acciaio—Steel
● Alluminio—Aluminium
● Legno—Wood

312	BAHAMA	●
314	HOLLY	●
316	ROUND	●
318	SHINE	●
322	SNOOZE	●
326	TERRAMARE	●
328	TIKI	●
330	YARD	●

BAHAMA

Design by EMU D&S Lab



Scansiona e scopri i progetti.
Scan and discover the projects.

170
Sdraio
Deck chair



Struttura in tubo di acciaio zincato a caldo internamente ed esternamente.
Inside and outside hot-dip zincated steel pipe.



Blocco anteriore basculante.
Tilting front block.



Sdraio pieghevole che occupa poco spazio nello spazio di rimessaggio.
Foldable and small to store deck chair.

COMBINAZIONI CONSIGLIATE—SUGGESTED MATCHINGS

312



ROUND
Cod. 483
Tavolo basso
Coffee table
PAG. 298



HOLLY
Cod. 195
Letino impilabile con ruote a scomparsa
Stackable sunbed with hidden wheels
PAG. 314



HOLLY
Cod. 196
Tavolo basso
Coffee table
PAG. 294

PRODOTTI—PRODUCTS



Codice/Code Tipologia/Typology	Disegno/Drawing	Info
-----------------------------------	-----------------	------

170
Sdraio
Deck chair
W58 - D108 - H95 Kg 5,4

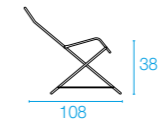
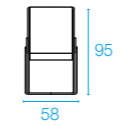

COLORI STRUTTURA/SEDUTA E SCHIENALE—FRAME/SEAT AND BACKREST COLORS

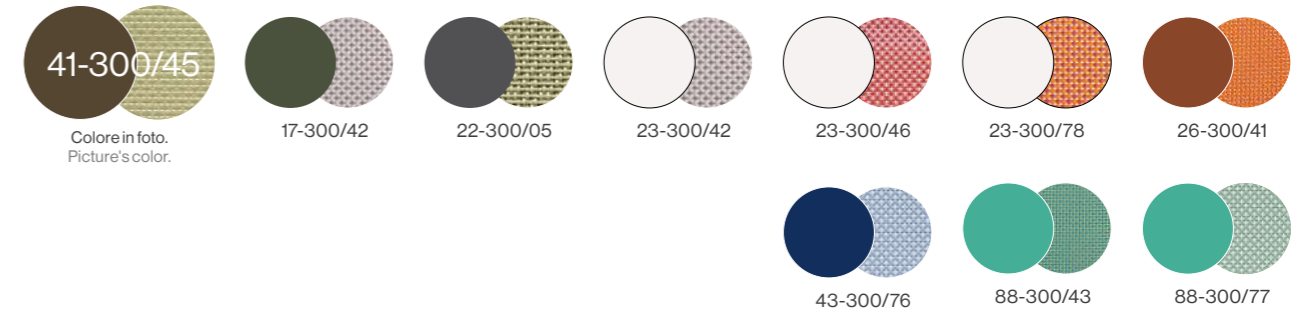

Le immagini dei colori sono a scopo illustrativo. Per vedere la trama degli EMU-Tex, consultare pg. 379.
All colors images shown are for illustration purposes only. Look at pg. 379 to see the texture of the EMU-Tex.

PLUS

• Un'icona intramontabile, da oltre 50 anni sul mercato, dal design attualissimo. Robusta, pratica, leggera e confortevole.— A timeless icon with a contemporary design, being on the market for over 50 years. Sturdy, handy, light, and comfortable.

313

HOLLY

Design by EMU D&S Lab



Scansiona e scopri i progetti.
Scan and discover the projects.

195

Lettino impilabile
con ruote a scomparsa

Stackable
sunbed with
hidden wheels



Dotato di piccole ruote a scomparsa, è estremamente facile e leggero da muovere.
Equipped with small hidden wheels, it is extremely easy and light to move.



Impilabilità fino a 8 pezzi.
The sunbed can be stacked up to 8 pieces.

PRODOTTI—PRODUCTS



Codice/Code Tipologia/Typology	Disegno/Drawing	Info
-----------------------------------	-----------------	------

195

Lettino impilabile
con ruote a scomparsa
Stackable sunbed with
hidden wheels
W202 - D79 - H 37/103
Kg 13,6

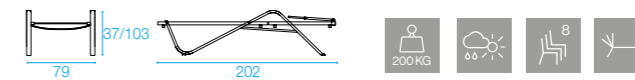

195/T

Tettino
Sunbed roof
W53 - D65 - H4
Kg 1,0

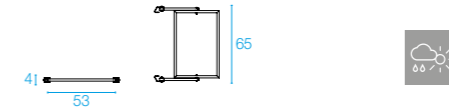

COLORI STRUTTURA/TELO—FRAME/CLOTH COLORS

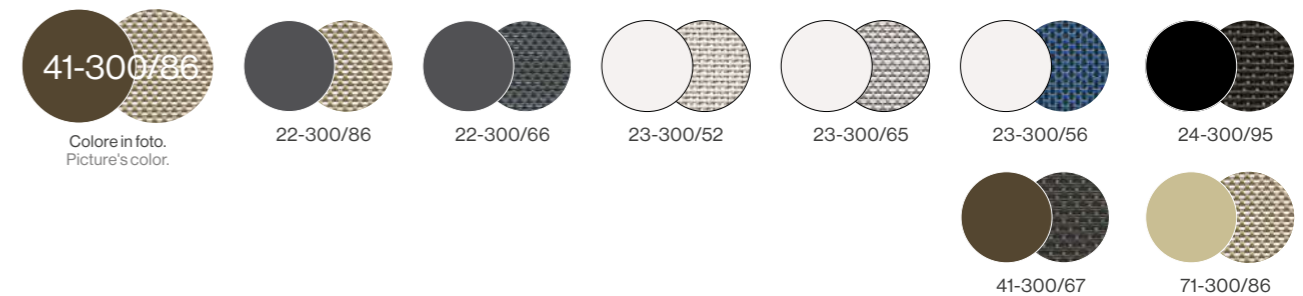

Le immagini dei colori sono a scopo illustrativo. Per vedere la trama degli EMU-Tex, consultare pg. 379.
All colors images shown are for illustration purposes only. Look at pg. 379 to see the texture of the EMU-Tex.

ALTRI PRODOTTI IN COLLEZIONE—OTHER COLLECTION'S PRODUCTS

314



HOLLY
Cod. 1311
Poltrona reclinabile
Reclining lounge chair
PAG. 72



HOLLY
Cod. 1313
Poggiapiedi
Footstool
PAG. 72



HOLLY
Cod. 196
Tavolo basso
Coffee table
PAG. 294

PLUS

- Struttura in estruso di alluminio.—Extruded aluminium pipe frame.
- Il tettino parasole è disponibile come accessorio.—The sunbed roof is available as accessory.
- Schienale reclinabile in diverse posizioni per un comfort ottimale.
The reclining backrest allow a great comfort in the different positions.
- La collezione, con il lettino, si completa e può arredare diversi ambienti e diverse destinazioni d'uso all'interno di uno stesso spazio contract con stile coordinato.
Sunbeds make the collection complete and suitable to furnish several contexts and different areas in the same contract environment with a coordinated style.
- L'intera collezione, per il suo material mix, risulta particolarmente adatta in ambienti marini e su imbarcazioni.—The collection, thanks to the material mix is very suitable to marine environment and boats.

315

ROUND

Design by Christophe Pillet



Scansiona e scopri i progetti.
Scan and discover the projects.

468

Lettino impilabile
Stackable
sunbed



Lettino ergonomico in lamiera stirata zincata a caldo.
Ergonomic sunbed made of hot-dip zincated sheet.



Tappi in acciaio zincato come protezione per le gambe durante impilamento.
Hot-dip zincated steel caps to preserve the legs when sunbeds are stacked.

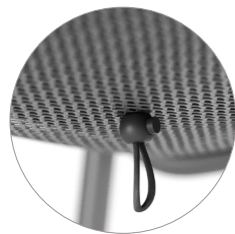

Fissaggio cuscino con elastici e fermacorda.
Cushion fastening with rubber band and clip.

PRODOTTI—PRODUCTS

Codice/Code Tipologia/Typology	Disegno/Drawing	Info
-----------------------------------	-----------------	------

468

Lettino impilabile
Stackable sunbed
W78 - D160 - H77
Kg 14,0

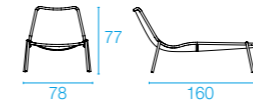

COLORI STRUTTURA—FRAME COLORS

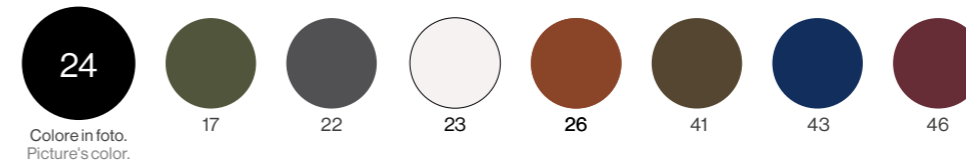

CUSCINO—CUSHION

Codice/Code Tipologia/Typology	Colori Colors	Categoria tessuto Fabric category
C/468 Cuscino intero acrilico Acrylic whole cushion x cod. 468 W132 - D47/65/52 - H4 Kg 1,6	<div style="display: flex; gap: 5px;"> <div style="border: 1px solid black; padding: 2px;">900/71</div> <div style="border: 1px solid black; padding: 2px;">900/75</div> <div style="border: 1px solid black; padding: 2px;">900/77</div> </div>	Tessuti Standard Standard Fabrics



ALTRI PRODOTTI IN COLLEZIONE—OTHER COLLECTION'S PRODUCTS

316



ROUND
Cod. 469
Poltrona
Lounge chair
PAG. 102



ROUND
Cod. 477
Tavolo basso
Coffee table
PAG. 298



ROUND
Cod. 482
Tavolo basso
Coffee table
PAG. 298

PLUS

• Cuscino C/468 sfoderabile.—C/468 removable cushion cover.

317

SHINE

Design by Arik Levy



Scansiona e scopri i progetti.
Scan and discover the projects.

295

Lettino impilabile con ruote a scomparsa

Stackable sunbed with hidden wheels



Le ruote a scomparsa garantiscono una facile trasportabilità e un pratico rimessaggio.
The hidden wheels guarantee an easy use and storage.

289

Daybed impilabile con ruote a scomparsa

Stackable daybed with hidden wheels



Dotato di vari accessori per implementarne gli usi: bracciolo/vassoio di appoggio, rete portaoggetti e tettino.
Various accessories are provided to implement the uses: armrest/support tray, storage net and roof.

PRODOTTI—PRODUCTS

Codice/Code Tipologia/Typology	Disegno/Drawing	Info	TEST
-----------------------------------	-----------------	------	------

295

Lettino impilabile con ruote a scomparsa
Stackable sunbed with hidden wheels
W209 - D77 - H36/97
Kg 17,6

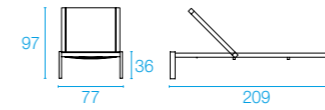

EN581-1/ EN581-2

289

Daybed impilabile con ruote a scomparsa
Stackable daybed with hidden wheels
W211 - D148 - H36/97
Kg 29,5

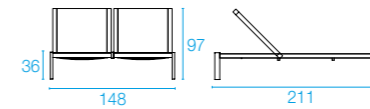

295B

N.1 bracciolo
N.1 armrest
x cod. 289, 295
W50 - D23 - H2 Kg 1,5



82



295R

Rete porta oggetti
Storage net
x cod. 289, 295
W45 - D50 Kg 0,1

295T

Tettino
Sunbed roof
x cod. 289, 295
W58 - D45 - H2 Kg 2,2

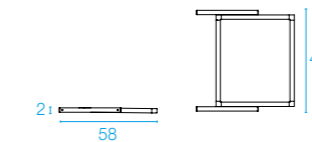

23	300/52
24	300/95
41	300/67
71	300/86

CUSCINI—CUSHIONS

Codice/Code Tipologia/Typology	Colori tessuto Fabric colors	Categoria tessuto Fabric category
-----------------------------------	---------------------------------	--------------------------------------

C/295

Cuscino intero acrilico
Acrylic whole cushion
x cod. 289, 295
W63 - D71-126 - H8 Kg 5,2

900/18
900/71
900/75
900/77

Tessuti Standard
Standard Fabrics

FC/295 Cover x cod. 295



COLORI STRUTTURA/TELO—FRAME/CLOTH COLORS

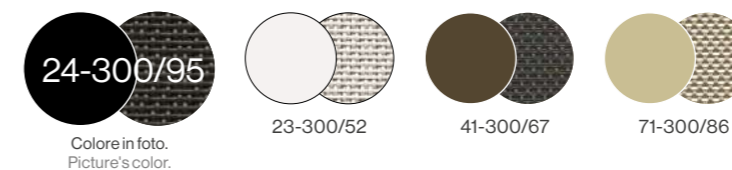

Le immagini dei colori sono a scopo illustrativo. Per vedere la trama degli EMU-Tex, consultare pg. 379.
All colors images shown are for illustration purposes only. Look at pg. 379 to see the texture of the EMU-Tex.

ALTRI PRODOTTI IN COLLEZIONE—OTHER COLLECTION'S PRODUCTS

318



SHINE
Cod. 252
Tavolo basso
Coffee table
PAG. 300



SHINE
Cod. 249
Poltrona
Lounge chair
PAG. 110



SHINE
Cod. 260
Divano
Sofa
PAG. 110

319

SHINE

Design by Arik Levy



Scansiona e scopri i progetti.
Scan and discover the projects.

6295
Lettino
Sunbed



Cremagliera in acciaio inossidabile per permettere la regolazione della posizione schienale.
Stainless steel rack to allow the various backrest inclinations.



Gamba esterna che ne permette l'impilabilità.
External leg that allows stackability.



Dotato di vari accessori per implementarne gli usi: tettino dal facile fissaggio, bracciolo/vassoio di appoggio e rete portaoggetti e tettino.
Various accessories are provided to implement the uses: easy to fix roof, armrest/support tray and storage net.

PRODOTTI—PRODUCTS



Codice/Code Tipologia/Typology	Disegno/Drawing	Info	TEST
-----------------------------------	-----------------	------	------

2695

Lettino impilabile con ruote a scomparsa
Stackable sunbed with hidden wheels
W212 - D82 - H36/95
Kg 21,5

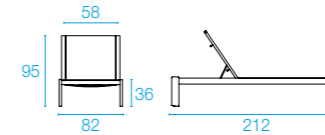

82

6295B

N.1 bracciolo
N.1 armrest
x cod. 6295
W50 - D23 - H2 Kg 1,6



6295P

N.1 bracciolo/vassoio
N.1 armrest/tray
W49 - D17,5 - H4 Kg 1,5
x cod. 6295

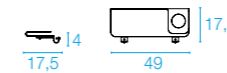

295R

Rete porta oggetti—Storage net
x cod. 6295
W45 - D50 Kg 0,1

295T

Tettino
Sunbed roof
x cod. 6295
W58 - D45 - H2 Kg 2,2

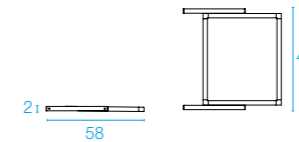

23	300/52
24	300/95
41	300/67
71	300/86

CUSCINI—CUSHIONS

Codice/Code Tipologia/Typology	Colori tessuto Fabric colors	Categoria tessuto Fabric category
C/295 Cuscino intero acrilico Acrylic whole cushion W63 - D71-126 - H8 Kg 5,2	900/18 900/71 900/75* 900/77	Tessuti Standard Standard Fabrics
FC/295 Cover		

COLORI STRUTTURA/TELO—FRAME/CLOTH COLORS



Le immagini dei colori sono a scopo illustrativo. Per vedere la trama degli EMU-Tex, consultare pg. 379.
All colors images shown are for illustration purposes only. Look at pg. 379 to see the texture of the EMU-Tex.

PLUS

- Struttura in teak FSC® per un piacevole effetto tattile e visivo.
FSC® teak for a pleasant touch, look and feel.
- Telo facilmente sostituibile.—Easy replacement cloth.

SNOOZE

Design by Chiaramonte—Marin



Scansiona e scopri i progetti.
Scan and discover the projects.

201
Sdraio
Deck chair



Braccioli impermeabili in EMU-Tex, con piastre in acciaio inossidabile, permettono di regolare l'inclinazione di questa sdraio in due diverse posizioni. Waterproof EMU-Tex armrests with stainless steel plates allow to recline this deck chair in two different positions.

204
Poggiapiedi
Footstool



207
Lettino impilabile
Stackable sunbed



PRODOTTI—PRODUCTS



Codice/Code Tipologia/Typology	Disegno/Drawing	Info	TEST
201 Sdraio Deck chair W75 - D91 - H105 Kg 7,9			EN581-1/EN581-2
204 Poggiapiedi Footstool W72 - D32 - H43 Kg 3,4			
207 Lettino impilabile Stackable sunbed W215 - D92 - H37/102 Kg 19,0			

COLORI STRUTTURA/SEDUTA E SCHIENALE—FRAME/SEAT AND BACKREST COLORS

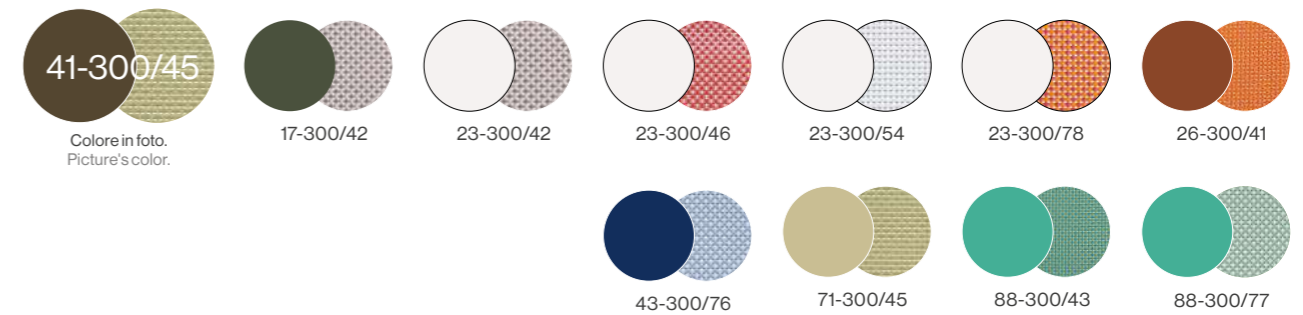

Le immagini dei colori sono a scopo illustrativo. Per vedere la trama degli EMU-Tex, consultare pg. 379.
All colors images shown are for illustration purposes only. Look at pg. 379 to see the texture of the EMU-Tex.

PLUS

- Seduta extra confortevole, avvolgente grazie alla sua concavità al naturale adattamento del tessuto in uso. Extra comfortable seat, enveloping through its concavity and the natural adaptation of the fabric in use.
- L'ampia gamma di colori disponibili rende questa collezione trasversale e adatta anche ai più svariati contesti contract.—The wide colors range makes this collection also suitable to various contract environments.
- Telo facilmente sostituibile attraverso la rimozione delle viti di fissaggio. Sunbed cloth easily replaceable by removing the fixing screws.
- Struttura in tubo di acciaio zincato a caldo ed EMU-Tex impermeabile. Frame in hot-dip zincated steel pipe and waterproof EMU-Tex.
- Cod. 207 lettino con ruote a vista, impilabile fino a 4 pezzi. Cod. 207 sunbed with visible wheels, stackable up to 4 pieces.



Scansiona e scopri i progetti.
Scan and discover the projects.

219
Sdraio Cozy
Cozy deck chair



Bracciolo in microfibra per un elegante effetto tattile e visivo.
Microfiber armrest for an elegant touch, look and feel.



Il telo in maglia sintetica è accoppiato all'imbottitura in filo drenante e, insieme alla struttura di acciaio, crea una seduta avvolgente e confortevole.
The synthetic mesh cloth paired to the inner draining padding, in combination with the steel frame, makes the seat enveloping and comfortable.

229
Poggiapiedi Cozy
Cozy footstool



PRODOTTI—PRODUCTS

Codice/Code Tipologia/Typology	Disegno/Drawing	Info
-----------------------------------	-----------------	------

219
Sdraio Cozy
Cozy deck chair
W75 - D91 - H105
Kg 9,6

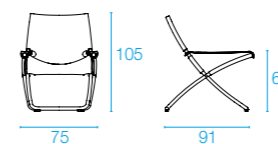

229
Poggiapiedi cozy
Cozy footstool
W72 - D32 - H43
Kg 3,4

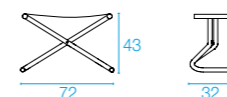

COLORI STRUTTURA/FRONTE TELO/RETRO TELO E BRACCIOLI FRAME/Front CLOTH/REAR CLOTH AND ARMRESTS

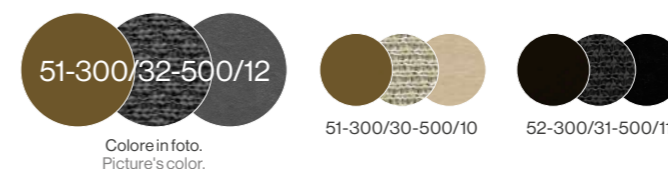

Le immagini dei colori sono a scopo illustrativo. Per vedere la trama delle maglie sintetiche, consultare pg. 378.
All colors images shown are for illustration purposes only. Look at pg. 378 to see the texture of the synthetic meshes.

ALTRI PRODOTTI IN COLLEZIONE—OTHER COLLECTION'S PRODUCTS



SNOOZE
Cod. 213
Poltroncina regista
Director's armchair
PAG. 116

PLUS

- Naturale evoluzione di Snooze, Cozy ne mantiene il comfort, la praticità, la funzionalità e il design, evolvendo in una versione imbottita per utilizzi che vanno oltre l'outdoor, come porticati, verande e ambienti interni.
Natural evolution of Snooze, Cozy keeps its comfort, practicality, functionality and design, evolving into a more padded version for uses beyond the outdoors like porches, verandas and interior contexts.
- Disponibili 2 colori in finitura lucida per la struttura, unicamente utilizzati per Snooze Cozy.
2 polished finishing colors available for the frame, exclusively used for Cozy Snooze.
- Telo esterno che permette un facile drenaggio dell'acqua.
An external cloth allows an easy water drainage.



Scansiona e scopri i progetti.
Scan and discover the projects.

727

Lettino impilabile
Stackable sunbed



L'ergonomicità della seduta ne garantisce solidità e comfort.
Ergonomic seat that guarantees strongness and comfort.



Impilabile.—Stackable.

ALTRI PRODOTTI IN COLLEZIONE—OTHER COLLECTION'S PRODUCTS

326



TERRAMARE
Cod. 733+736P
Tavolo basso medio
Medium coffee table
PAG. 302



TERRAMARE
Cod. 726
Tavolo smart
Smart table
PAG. 218

PRODOTTI—PRODUCTS

Codice/Code Tipologia/Typology	Disegno/Drawing	Info	TEST
-----------------------------------	-----------------	------	------

727

Lettino impilabile
Stackable sunbed
W203 - D92 - H64
Kg 13,6

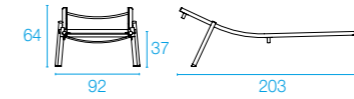

EN581-1/ EN581-2

COLORI STRUTTURA/TELO—FRAME/CLOTH COLORS



Colore in foto.
Picture's color.

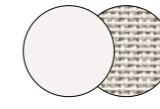

23-300/52

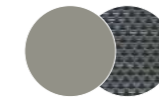

37-300/66

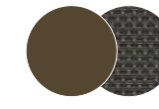

41-300/67

Le immagini dei colori sono a scopo illustrativo. Per vedere la trama degli EMU-TEX, consultare pg. 379.
All colors images shown are for illustration purposes only. Look at pg. 379 to see the texture of the EMU-TEX.

PLUS

- Struttura in tubolare di lega di alluminio. Telo in EMU-TEX che permette l'utilizzo del lettino anche senza cuscino.— Aluminium alloy tubular frame. EMU-TEX cloth that allows use even without cushion.
- Giunti alla base in pressofusione di alluminio, segno distintivo dell'intera collezione Terramare. The die-cast aluminum joints are the distinctive sign of the collection.
- L'intera collezione, per il suo material mix, risulta particolarmente adatta in ambienti marini e su imbarcazioni.— The collection, thanks to the material mix is very suitable to marine environment and boats.

327



Scansiona e scopri i progetti.
Scan and discover the projects.

198 Lettino impilabile Stackable sunbed



Grande attenzione e ricercatezza estetica per un prodotto dalle linee pulite. Profili in alluminio realizzati per nascondere tutti gli elementi strutturali e donare armonia al design.
Great attention and aesthetic refinement for a product with neat lines. Aluminium profiles conceal all structural elements and enhance design harmony.

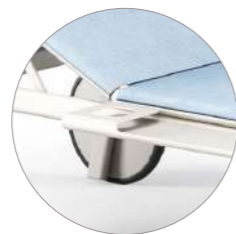

Configurabile con accessori: ruote di grandi dimensioni, bracciolo/vassoio laterale, telo portaoggetti e tettino in EMU-Tex.
Available accessories: large wheels, armrest/tray, storage cloth and sunbed roof in EMU-Tex.



Impilabile.—Stackable.

COMBINAZIONI CONSIGLIATE—SUGGESTED MATCHINGS



YARD
Cod. 509
Tavolo basso
Coffee table
PAG. 306



CIAK
Cod. 974
Poltroncina regista
Director's armchair
PAG. 44

PRODOTTI—PRODUCTS



Codice/Code Tipologia/Typology	Disegno/Drawing	Info
198 Lettino impilabile Stackable sunbed W200 - D67 - H37/101 Kg 12,2		
198B N.1 bracciolo/vassoio N.1 armrest/tray W49 - D17,5 - H4 Kg 1,5		
198P Telo portaoggetti Storage cloth W88 - D50,5 - H2 Kg 0,3		
198R N.2 ruote N.2 wheels ø27 - H5 una—each Kg 0,8		
198T Tettino Sunbed roof W40 - D62 - H2 Kg 1,5		

COLORI STRUTTURA/TELO X COD. 198, 198T—FRAME/CLOTH COLORS X COD. 198, 198T

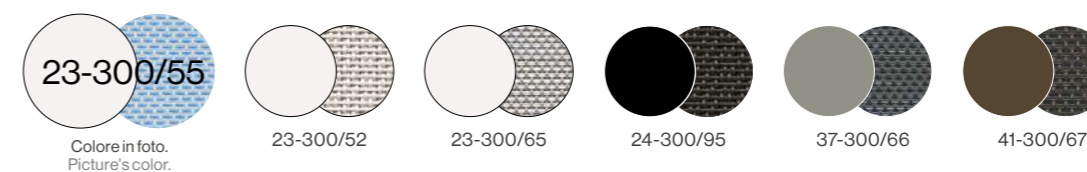

COLORI STRUTTURA X COD. 198B, 198R—FRAME COLORS X COD. 198B, 198R

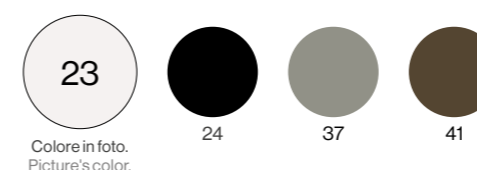

COLORI TELO X COD. 198P—CLOTH COLORS X COD. 198P

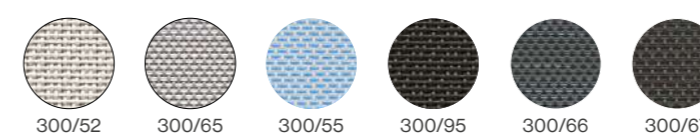

Le immagini dei colori sono a scopo illustrativo. Per vedere la trama degli EMU-Tex, consultare pg. 379.
All colors images shown are for illustration purposes only. Look at pg. 379 to see the texture of the EMU-Tex.

*Impilabile a 6 senza le ruote. Impilabile a 4 con le ruote ma senza bracciolo/i. Impilabile a 2 con ruote e bracciolo/i.
Without the wheels, stackable up to 6 units. With the wheels but without the armrests, stackable up to 4 units. With the wheels and the armrests, stackable up to 2 units.

PLUS

- Possibilità di smontare il telo per una facile sostituzione.
Removable cloth for an easy replacement.
- Impilabile anche con le ruote.—Stackable even with wheels.
- La grande leggerezza e la solidità delle ruote ne permettono una facile movimentazione.
Easy to handle thanks to its lightness and wheels solidity.
- La collezione, per il suo material mix, risulta particolarmente adatta in ambienti marini e su imbarcazioni.
The collection, thanks to the material mix is very suitable to marine environment and boats.



Scansiona e scopri i progetti.
Scan and discover the projects.

504

Lettino impilabile
Stackable sunbed



Struttura in alluminio e cinghie in fibre di polipropilene e fili di gomma sintetica.
Aluminium frame with belts made of polypropylene fibres and synthetic rubber threads.



Schienale reclinabile.
Reclining backrest.



Impilabile.—Stackable.

ALTRI PRODOTTI IN COLLEZIONE—OTHER COLLECTION'S PRODUCTS

330



YARD
Cod. 509
Tavolo basso
Coffee table
PAG. 306



YARD
Cod. 500
Sedia
Chair
PAG. 140



YARD
Cod. 533
Sgabello
Barstool
PAG. 140

PRODOTTI—PRODUCTS

Codice/Code Tipologia/Typology	Disegno/Drawing	Info
-----------------------------------	-----------------	------

504

Lettino impilabile
Stackable sunbed
W200 - D75 - H38/101 Kg 15,4

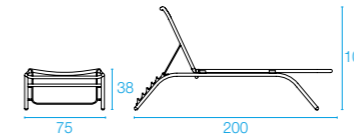

COLORI STRUTTURA/SEDUTA E SCHIENALE—FRAME/SEAT AND BACKREST COLORS

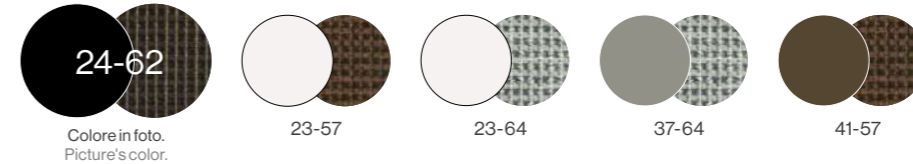

Le immagini dei colori sono a scopo illustrativo. Per vedere la trama delle cinghie elastiche, consultare pg. 380.
All picture's colors are for illustration purposes only. Look at pg. 380 to see the texture of the elastic belts.

ACCESSORI—ACCESSORIES

Codice/Code Tipologia/Typology	Colori tessuto Fabric colors
-----------------------------------	---------------------------------

FC/295 Cover x cod. 504



PLUS

- La struttura in alluminio, leggera ma robusta, ne consente l'uso anche in ambienti marini.
The light but strong aluminium frame allows the usage in marine contexts.
- L'esclusivo e brevettato sistema di fissaggio delle cinghie ne permette anche la sostituzione.
The exclusive and patented belts fixing system allows an easy replacement in case of damage.
- Comfort elevato grazie al sistema di cinghie intrecciate che ne consente l'utilizzo senza cuscini.
High comfort thanks to the belts weaving allowing the use without cushions.

331



COMPLEMENTI COMPLEMENTS

Cucine, tappeti, luci, sculture di design, divisori, contenitori, fioriere e covers: gli accessori EMU sono complementi di arredo indispensabili in termini di funzionalità ed estetica, pensati anche per le necessità del mondo outdoor contract. La varietà di colori e materiali disponibili li rendono elementi trasversali perfettamente abbinabili a tutte le collezioni, con cui definire e proporre soluzioni di stile total look.

Kitchens, rugs, lights, design sculptures, dividers, containers, planters and covers: EMU accessories are functional and aesthetically pleasing additions to any outdoor contract space. The range of finishes and available materials make for adaptable elements that can easily be paired with all the collections and used to define and propose "total look" style solutions.

INDEX

LEGENDA—LEGEND
● Acciaio—Steel
● Alluminio—Aluminium
● Legno—Wood

334	CAMALEON	●
338	CONE	●
342	EMILY	●
346	FIGUS	●
350	HEAVEN	●
352	LUCIOLE	
354	OTTOMAN	
356	PATCHWALL	●
358	RE-TROUVÉ	●
360	RED CARPET	

CAMALEON

Design by Andreucci—Hoisl



Scansiona e scopri i progetti.
Scan and discover the projects.



Composizione 1 Composition 1

2050 + 2055 + 2x2057 + 2058 + 2052



23

Colore in foto.
Picture's color.



L'utilizzo dell'accessorio spalliera assolve la funzione di separazione.
By adding the divider grid, spaces can be effectively managed and separated.

Esempio di possibili composizioni—Possible combinations

Composizione 2 Composition 2

2050 + 2055 + 3x2057 + 2060 + 2x2061 + 2052



23

Colore in foto.
Picture's color.



Tale composizione modulare permette di realizzare spazi contenitori per rimessaggio di stoviglie, lampade, cuscini o altri oggetti e allo stesso tempo di creare vani privati.
This composition allows to have storage cases for tableware, lamps, cushions or other objects and also to create private corners.

Esempio di possibili composizioni—Possible combinations

Composizione 3 Composition 3

2050 + 2051 + 3x2056 + 2057 + 2x2058 + 2055



41

Colore in foto.
Picture's color.



Vani contenitori in lamiera di acciaio zincata a caldo piegata e saldata a proiezione per una maggiore pulizia degli angoli e dei profili.
Case in moulded and projection welded pre hot-dip zincated sheet for a greater precision in corners and edges.

Esempio di possibili composizioni—Possible combinations

PRODOTTI—PRODUCTS

Codice/Code Tipologia/Typology	Disegno/Drawing	Info
-----------------------------------	-----------------	------

2050

Modulo base
Base module
W120 - D46 - H85
Kg 8,4

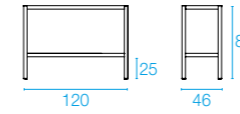

2051

Modulo superiore
Upper module
W120 - D46 - H55
Kg 5,0



2052

Spalliera
Divider grid
W120 - D4 - H84,5
Kg 8,0

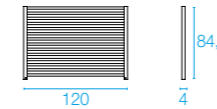

2060

Chiusura anteriore e posteriore
Front and back closing
W112 - D4 - H56
Kg 6,8
x cod. 2050, 2051



2061

Chiusura laterale
Lateral closing
W37 - D4 - H56
Kg 2,3
x cod. 2050, 2051



2059

Kit ante scorrevoli per chiusura anteriore
Sliding doors kit for front closing
W112 - D56,5 - H6
Kg 8,0
x cod. 2050, 2051

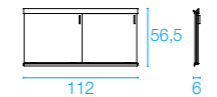

COLORI STRUTTURA—FRAME COLORS

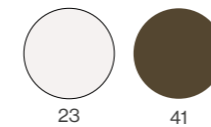

Codice/Code
Tipologia/Typology

2063

Fissaggi e connessioni
Fasteners and connectors
x cod. 2050



CAMALEON

Design by Andreucci—Hoisl



Scansiona e scopri i progetti.
Scan and discover the projects.



Composizione 4

Composition 4

2050 + 2051 + 2x2055 + 2060 + 2x2061 + 3x2057



Colore in foto.
Picture's color.



Pianetti in teak FSC® che possono essere utilizzati a qualsiasi livello della composizione creando così una superficie di appoggio dal piacevole effetto tattile e visivo. Teak FSC® shelves can be used for every layer of each composition for a pleasant touch, look and feel of working surfaces.

Esempio di possibili composizioni—Possible combinations

Composizione 5

Composition 5

2050 + 2055 + 3x2057 + 2060 + 2x2061 + 2059



Colore in foto.
Picture's color.



Modulo base dall'altezza 85cm, fruibile come piano di appoggio sia in utilizzo contract che privato. 85cm height base module suitable for working surfaces both for contract and private uses.

Esempio di possibili composizioni—Possible combinations

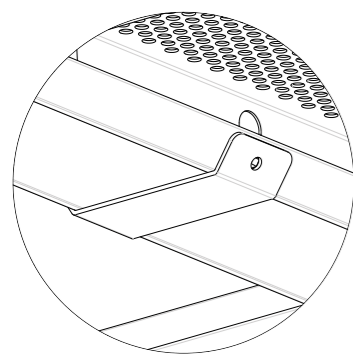

Connettore di fissaggio fra moduli.
Connector between modules.

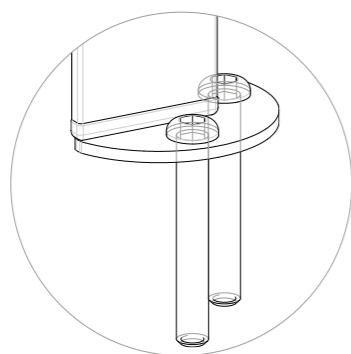

Possibilità di fissaggio a terra tramite placca in acciaio inossidabile.
Stainless steel ground anchorage.



Anta scorrevole in acciaio zincato per creare spazi di rimessaggio completamente chiusi, con pratica maniglia. Hot dip zincated steel sliding door to create completely closed storage spaces, supplied with a practical handle.

PRODOTTI—PRODUCTS

Codice/Code Tipologia/Typology	Disegno/Drawing	Info
-----------------------------------	-----------------	------

2055

Ripiano grande in lamiera
Steel sheet big shelf
W112 - D37 - H2
Kg 4,7



2056

Ripiano grande in lamiera forata
Perforated steel sheet
small shelf
W37 - D37 - H2
Kg 1,1



2057

Ripiano piccolo in Teak
Teak small shelf
W37 - D37 - H3
Kg 1,9



2058

Fioriera
Flower box
W37 - D37 - H23
Kg 4,4

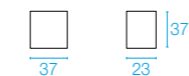

COLORI STRUTTURA X COD. 2055, 2056—FRAME COLORS X COD. 2055, 2056

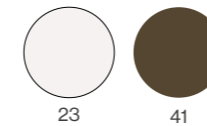

COLORI STRUTTURA X COD. 2057—FRAME COLORS X COD. 2057

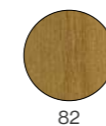

COLORI STRUTTURA X COD. 2058—FRAME COLORS X COD. 2058

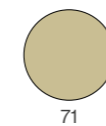

PLUS

- Modulare e versatile, Camaleon da la possibilità di creare molteplici combinazioni e di modificarle o implementarle nel tempo.—Camaleon is a modular and versatile system that allows several possible combinations switchable with additional modules.
- Possibilità di utilizzo in contesti sia contract che privati.
Versatility for both contract and residential environments.
- Solidità della struttura in alluminio.—Strength of the aluminium frame.
- Profili in estruso di alluminio design esclusivo EMU.
Aluminium extrusion profiles exclusively designed by EMU.
- Piani in lamiera piena e pianetti in lamiera forata, entrambi zincati a caldo per una maggiore resistenza strutturale.
Shelves and perforated metal sheet small shelves, both hot-dip zincated for a greater structural resistance.
- Possibilità di sostituire componenti.—Opportunity to replace components.
- Smontabilità e disassemblabilità dei componenti per una corretta raccolta differenziata e smaltimento green a fine vita.—Dismantlement of different components for a correct recycling and ecological disposal.
- Sottopiedi regolabili.—Adjustable feet.

CONE

Design by Chiaramonte—Marin



Scansiona e scopri i progetti.
Scan and discover the projects.

2001 Lampada piccola Small lamp

Luce led 2,3 watt 3000k, max 720 lm.
Accumulatori al litio ricaricabili da rete.
Durata batteria 7 ore.
Ricarica in 9 ore.
Voltaggio 3,7 V.
2,3 watt 3000k max 720 lm led light.
Rechargeable lithium accumulators.
Battery autonomy: 7 h.
Battery recharging time: 9 h.
Voltage 3,7 V.



Dress code 900/92



Dress code 900/93



Dress code 900/94



Dress code 900/96



Dress code 900/99

Colore in foto.
Picture's color.

2002 Lampada grande Big lamp

Luce led 4,2 watt 3200k, max 629 lm.
Accumulatori al litio ricaricabili da rete.
Durata batteria 5 ore.
Ricarica in 9 ore.
Voltaggio 3,7 V.
4,2 watt, 3200k max 629 lm led light.
Rechargeable lithium accumulators.
Battery autonomy: 5 h.
Battery recharging time: 9 h.
Voltage 3,7 V.



2003 Lampada a sospensione Hanging lamp

Alimentazione 230 volt.
Portalampada E27.
Power supply 230 volt.
Lampholder E27.



PRODOTTI—PRODUCTS



Codice/Code Tipologia/Typology	Disegno/Drawing	Info
-----------------------------------	-----------------	------

2001 Lampada piccola Small lamp ø17,5 - H22 Kg 0,6		
--	--	--

2002 Lampada grande Big lamp ø47 - H60 Kg 3,3		
---	--	--

2003 Lampada a sospensione Hanging lamp ø70 - H72 Kg 5,4		
--	--	--

COLORI STRUTTURA/PARALUME X COD. 2001, 2002—FRAME/LAMPSHADE COLORS X COD. 2001, 2002

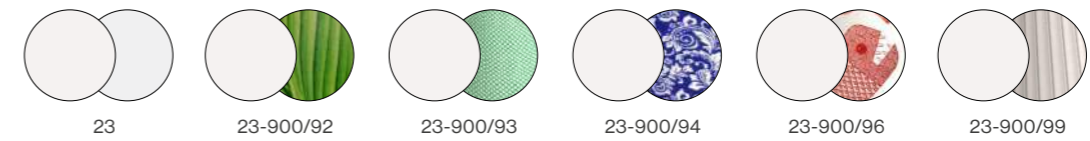

COLORI STRUTTURA/DRESS CODE X COD. 2003—FRAME/DRESS CODE COLORS X COD. 2003

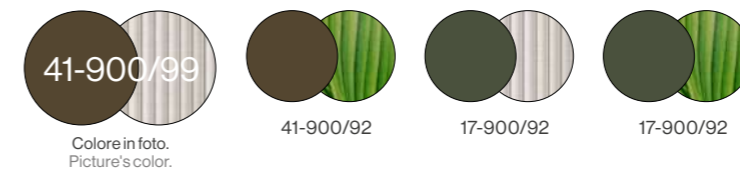

Codice/Code Tipologia/Typology	Colori Colors
DC/2001 Dress code poliestere—Polyester dress code x cod. 2001	
DC/2002 Dress code poliestere—Polyester dress code x cod. 2002	

PLUS

• 15 diversi dress code (disponibili solo per cod. 2001, 2002) rendono il prodotto flessibile e adeguato a diversi contesti d'uso e stili di arredamento. E' inoltre disponibile l'opzione di personalizzazione del dress code per cod. 2001 con una quantità minima di 20 pezzi.

The 5 different dress codes (only available for cod. 2001, 2002) make the product flexible and suitable for many contexts and furnishing styles. Furthermore the option of dress code customization is available for cod. 2001, with a minimum order quantity of 20 pieces.

CONE

Design by Chiaramonte—Marin



Scansiona e scopri i progetti.
Scan and discover the projects.

2004A+2004B+2004D+2005

Lampada da terra
Floor lamp

Alimentazione 230 volt.
Portalampana E27.
Power supply 230 volt.
Lamp holder E27.



2007A+2007B+2007D

Lampada da terra ricaricabile
Rechargeable floor lamp

Luce led 4,2 watt
3200k, max 629 lm.
Accumulatori al litio ricaricabili da rete.
Durata batteria 5 ore.
Ricarica in 9 ore.
Voltaggio 3,7 V.
4,2 watt, 3200k
max 629 lm led light.
Rechargeable lithium accumulators.
Battery autonomy: 5 h.
Battery recharging time: 9 h.
Voltage 3,7 V.



Colore in foto.
Picture's color.



Dress code
900/92

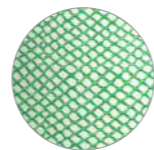

Dress code
900/93



Dress code
900/94

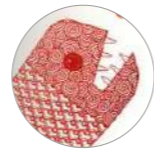

Dress code
900/96



Dress code
900/99

PRODOTTI—PRODUCTS



Codice/Code Tipologia/Typology	Disegno/Drawing	Info
-----------------------------------	-----------------	------

2004A+2004B+2004D

Lampada da terra
Floor lamp
W106 - D229 - H271
Kg 17,6

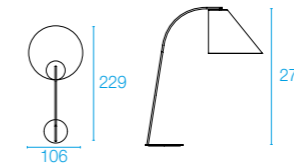

2007A+2007B+2007D

Lampada da terra ricaricabile
Rechargeable
floor lamp
W43 - D43 - H170
Kg 10,0

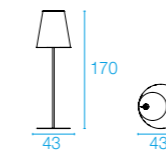

COLORI STRUTTURA/DRESS CODE X COD. 2004A, 2004B, 2004D
FRAME/DRESS CODE COLORS X COD. 2004A, 2004B, 2004D

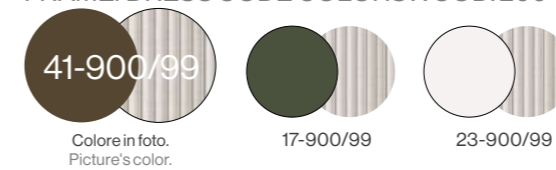

COLORI STRUTTURA/PARALUME X COD. 2007A, 2007B, 2007D
FRAME/LAMPSHADE COLORS X COD. 2007A, 2007B, 2007D

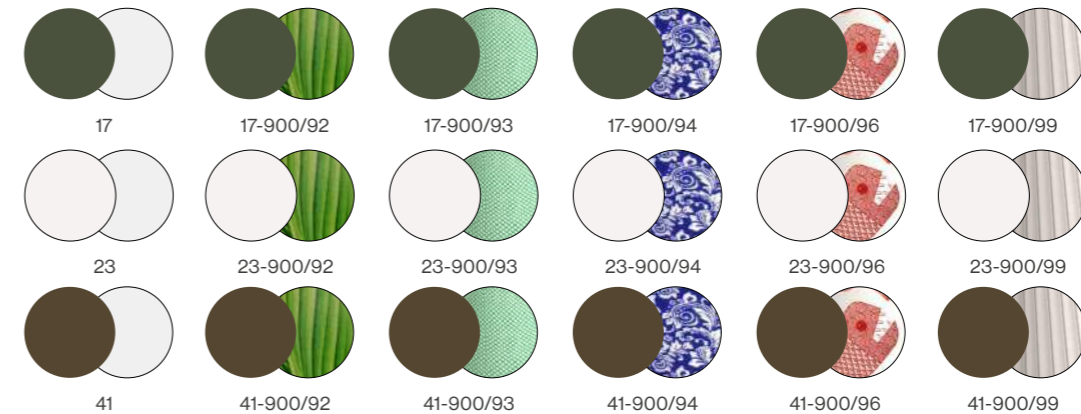

Codice/Code Tipologia/Typology	Colori Colors
-----------------------------------	------------------

2005

Base x cod. 2004
ø90 - H1 Kg 59,4



2006

Picchetto—Stake x cod. 2004
ø1,2 - H60 Kg 0,6



DC/2002

Dress code poliestere—Polyester dress code
x cod. 2007

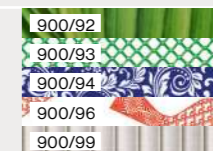

PLUS

- 15 diversi dress code (disponibili solo per cod. 2007) rendono il prodotto adatto a diversi stili di arredo.—The 5 different dress codes (only available for cod. 2007) make the product suitable for various furnishing styles.
- Base per fissaggio x cod. 2004 disponibile come accessorio.
Fixing base available as accessory x cod. 2004.

EMILY

Design by EMU D&S Lab



Scansiona e scopri i progetti.
Scan and discover the projects.



7004+7006+7008+7009

Composizione base (lavello e induzione)

Base combination (sink and induction cooktop)



Gambe in estruso di alluminio con profilo esclusivo. Effetto sospeso per un design più caratterizzante, una maggiore funzionalità e facilità di manutenzione negli ambienti outdoor.

Legs in extruded aluminium with exclusive profile. Ground-raised layout for a more characterizing design, greater functionality and ease of maintenance in outdoor environments.



Top con sottopiano sagomato in alluminio e scocca poliuretano rivestita in gres porcellanato. Top with shaped aluminium under-top and polyurethane shell covered in porcelain stoneware.

7000+7002+7003+7004+7006+7008+7009+7010

Composizione standard

Standard combination



PRODOTTI—PRODUCTS

Codice/Code Tipologia/Typology	Disegno/Drawing	Info
7000 Modulo chiuso neutro—Closed module W100 - D78 - H87,5 Kg 46,0		
7002 Modulo laterale dx o sx—Right or left lateral module W30 - D75 - H64 Kg 17,9		
7003 Modulo chiuso per barbecue Barbecue closed module W100 - D78 - H87,5 Kg 30,0		
7004 Modulo chiuso per lavello e miscelatore o induzione Closed module for sink and faucet or induction cooktop W100 - D78 - H87,5 Kg 36,0		
7006 Miscelatore in acciaio inox—Stainless steel faucet x cod. 7004, 7005 W9 - D25 - H31,5 Kg 1,7		
7008 Lavello in acciaio inox—Stainless steel sink x cod. 7004, 7005 W44 - D50 - H21 Kg 6,5		
7009 Piano cottura a induzione in cristallo Glass induction cookpit x cod. 7004, 7005 W44 - D50 - H27 Kg 6,5		
7010 Barbecue x cod. 7003 W96 - D61,5 - H38 Kg 45,0		

COLORI STRUTTURA/PIANO—FRAME/TOP COLORS

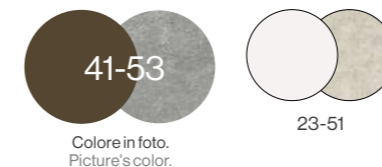

PLUS

- Emily è l'outdoor cooking system EMU, un sistema modulare outdoor in alluminio con piano in gres, composto da elementi assemblabili che possono essere utilizzati singolarmente o combinati tra loro.
Emily is the EMU outdoor cooking system, a modular system in aluminum with a porcelain stoneware top, made of assembled elements that can be used individually or combined with each other.
- Possibilità di creare molteplici combinazioni adatte a diverse funzionalità e contesti di utilizzo.
Possibility of creating multiple combinations suitable for different functions and contexts of use.
- Varietà di composizioni creabile grazie alla presenza di vari moduli facilmente assemblabili.
Variety of compositions can be created thanks to the presence of various easily assembled modules.
- Predisposizione al fissaggio tra moduli tramite apposita piastra nascosta sotto il piano, di facile applicazione.
Pre-arranged plate hidden under the top, for easy fastening between modules.
- Ogni modulo viene consegnato già montato, al fine di facilitare la fase di assemblaggio per l'utente finale.
Each module is delivered already assembled, in order to facilitate any process for the end user.
- Ciascun modulo può ospitare elettrodomestici e assolvere le varie funzioni di cottura, lavaggio, barbecue o semplice piano di appoggio.— Each module can house appliances and perform the various functions of cooking, washing, barbecuing, or simple support surface.
- Modulo laterale che, oltre a conferire carattere estetico, rappresenta una zona salvaspazio e di stoccaggio, con sportello apribile da entrambi i lati.— The lateral module gives additional aesthetic character and works as space-saving and storage area, with a door that can be opened from both sides.



ACCESSORI—PRODUCTS

Codice/Code Tipologia/Typology	Info
7011 Kit pane pizza BBQ—BBQ bread pizza kit x cod. 7003 W74 - D43 - H9 Kg 10,5	
7012 Griglia double—Double grill x cod. 7003 W25 - D43 - H2 Kg 1,3	
7013* Coperchio piano cottura—Induction cookpit cover x cod. 7004, 7005 W47,5 - D53,5 - H5,5 Kg 2,4	
7014 Pannello chiusura laterale—Side closing panel x cod. 7000, 7003, 7004 W76 - D65 - H0,3 Kg 4,0	
7015 Pietra ollare—Soapstone x cod. 7003 W25 - D43 - H2 Kg 6,5	
7016 Piastra inox—Stainless steel plate x cod. 7003 W25 - D43 - H0,7 Kg 3,3	
7017 Kit cottura indiretta 250—250 indirect cooking kit x cod. 7003 W43 - D25 - H9 Kg 2,7	
7018 Kit cottura indiretta 500 e affumicatura 500 indirect cooking and smoking kit x cod. 7003 W43 - D25 - H9 Kg 2,7	

23
41

* Raccomandato in caso di moduli esposti alle intemperie.
Recommended for modules exposed to bad weather.



FICUS

Design by Chiaramonte—Marin



Scansiona e scopri i progetti.
Scan and discover the projects.

1230
Modulo base
Base module



1231
Modulo aggiuntivo
Additional module



PRODOTTI—PRODUCTS



Codice/Code Tipologia/Typology	Disegno/Drawing	Info
1230 Modulo base Base module W142 - D62,5 - H178,5 Kg 53,0		
1231 Modulo aggiuntivo Additional module W88 - D42,5 - H138 Kg 14,0		

COLORI STRUTTURA—FRAME COLORS



Colore in foto.
Picture's color.





Scansiona e scopri i progetti.
Scan and discover the projects.

1232
Foglia Jolly
Jolly leaf



1233
Frutto
Fruit



PRODOTTI—PRODUCTS



Codice/Code Tipologia/Typology	Disegno/Drawing	Info
-----------------------------------	-----------------	------

1232
Foglia Jolly
Jolly leaf
W38 - D9,5 - H49
Kg 2,8

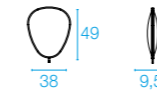

1233
Frutto
Fruit
W8,5 - D8 - H15
Kg 0,4

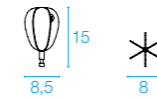

COLORI STRUTTURA X COD. 1232—FRAME COLORS X COD. 1232



Colore in foto.
Picture's color.

COLORI STRUTTURA X COD. 1233—FRAME COLORS X COD. 1233



Colore in foto.
Picture's color.

PLUS

- Sapiente lavorazione del tubo di acciaio e della lamiera stirata pre zincata a caldo, che si uniscono in una scultura metallica dal design distintivo.—Steel pipe and pre hot-dip zincated expanded sheet are skillfull manufactured and merge into a unique and distinctive designed metal sculpture.
- Moduli assemblabili per diverse configurazioni e dimensioni.
Assemblable modules creating different combinations and sizes.
- 2 diverse colorazioni di foglia jolly e la possibilità di aggiungere i frutti rendono il prodotto maggiormente personalizzabile.—2 different colors of jolly leaf in combination with the option to add fruits make the product highly customizable.



Scansiona e scopri i progetti.
Scan and discover the projects.

497
Vaso alto
Tall vase

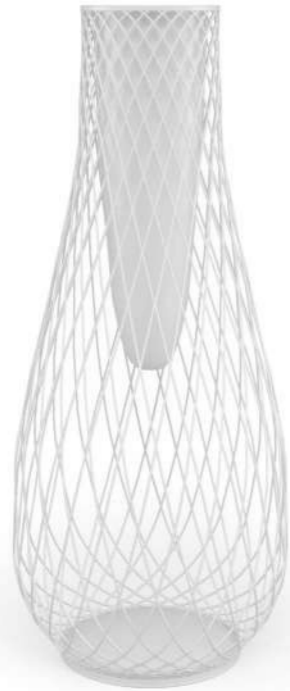

498
Vaso basso
Short vase

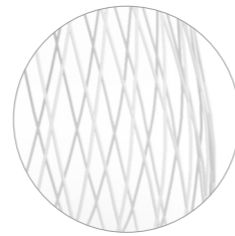
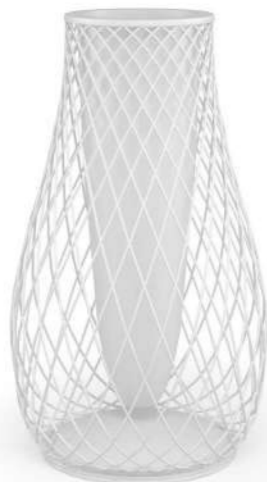

Sinuoso reticolo di tondini zincati crea forme classiche e affascinanti.
Sinuous grid of zinc-plated bars that creates classic and fascinating shapes.

PRODOTTI—PRODUCTS



Codice/Code Tipologia/Typology	Disegno/Drawing	Info
-----------------------------------	-----------------	------

497

Vaso alto
Tall vase
ø68 - H163
Kg 23,2

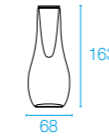

498

Vaso basso
Short vase
ø60 - H103
Kg 20,4

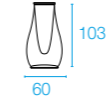

COLORI STRUTTURA—FRAME COLORS



Colore in foto.
Picture's color.

PLUS

- Rete zincata a caldo.—Hot-dip zinc-plated mesh.
- Saldatura a proiezione della rete alla struttura in tubolare che conferisce un migliore effetto estetico.
Spot welding of the mesh to the tubular frame for a more refined aesthetic effect.



Scansiona e scopri i progetti.
Scan and discover the projects.

2010 Lampada piccola Small lamp

Luce led 1,5 watt 3000k dimmerabile.
Accumulatori al litio ricaricabili da rete.
Durata batteria 8 ore.
Ricarica in 9 ore.
1,5 watt 3000k dimmerable led light.
Rechargeable lithium accumulators.
Battery autonomy: 8 h.
Battery recharging time: 9 h.



2011+2010 Lampada con picchetto piccolo Lamp with short spike



2012+2010 Lampada con picchetto medio Lamp with medium spike



2013+2010 Lampada con picchetto alto Lamp with tall spike



PRODOTTI—PRODUCTS



Codice/Code Tipologia/Typology	Disegno/Drawing	Info
2010* Lampada piccola Small lamp W10,5 - D10,5 - H30 Kg 0,33		
2011 Picchetto piccolo Short spike ø2 - H53 Kg 0,3		
2012 Picchetto medio Medium spike ø2 - H83 Kg 0,5		
2013 Picchetto alto Tall spike ø2 - H133 Kg 0,8		

*Corpo illuminante con tappo USB rimovibile. Interruttore on-off a sfioramento.
Base magnetica per favorire la stabilità su superfici in metallo.
*Lighting device with removable USB lid. Soft touch for on-off switch.
Magnetic base to ensure a more stable standing on metal table tops.

COLORI STRUTTURA X COD. 2010—FRAME COLORS X COD. 2010

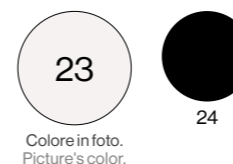

COLORI STRUTTURA X COD. 2011, 2012, 2013—FRAME COLORS X COD. 2011, 2012, 2013

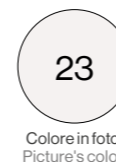

PLUS

- Led ricaricabile integrato nel corpo illuminante rimovibile.
Rechargeable led assembled into the lighting device.
- Base magnetica.—Magnetic base.
- 3 possibili usi: lampada da tavolo, da terra e a sospensione in abbinamento con collezioni ombrelloni Piazzetta, Trevi e Navona.—3 possible uses: table and ground lamp, hanging lamp in combination with Piazzetta, Trevi and Navona sunshade collections.



Scansiona e scopri i progetti.
Scan and discover the projects.



PRODOTTI—PRODUCTS

Codice/Code Tipologia/Typology	Disegno/Drawing	Info
-----------------------------------	-----------------	------

3003

Tappeto
Rug

W200 - D300 - H1
Kg 11,6



COLORI TAPPETO/BORDO—RUG/BORDER COLORS



900/44 900/45 900/46

Le immagini dei colori sono a scopo illustrativo. Per vedere la trama dei Tessuti Tappeti consultare pg. 430.
All picture's colors are for illustration purposes only. Look at pg. 430 to see the texture of the Rugs Fabrics.

3003
Tappeto
Rug



900/44
Colore in foto.
Picture's color.

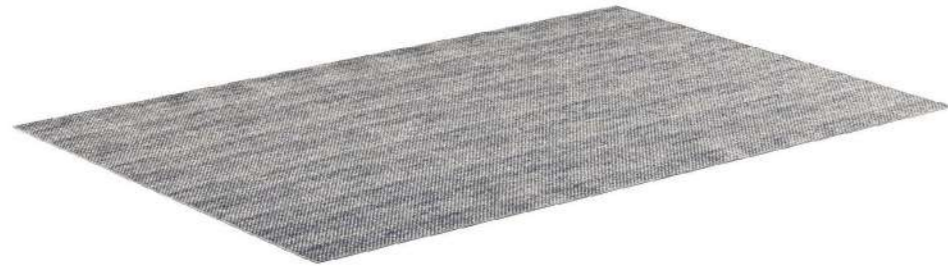

3003
Tappeto
Rug



900/45
Colore in foto.
Picture's color.

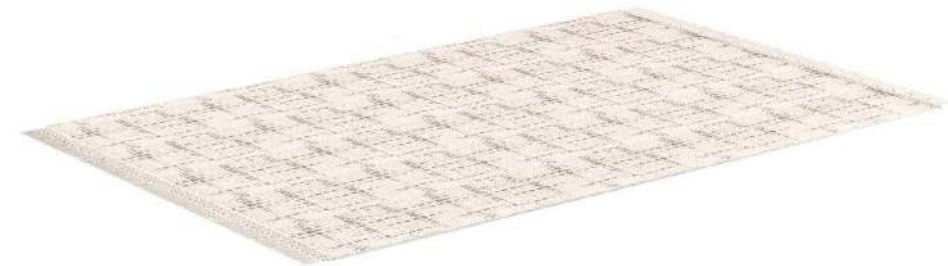

3003
Tappeto
Rug



900/46
Colore in foto.
Picture's color.



900/44



900/45



900/46

PLUS

- I tappeti della collezione Ottoman, fatti a mano, prevedono texture e trame esclusivamente disegnate per EMU.

Ottoman collection includes handmade rugs with textures and patterns exclusively designed for EMU.

- Composta da 3 diverse colorazioni, permette un facile mix&match con le altre collezioni.

Composed by three different colors, it allows an easy mix&match with the other collections.

- Realizzati in polipropilene, questi tappeti sono lavabili, duraturi e disponibili in diverse fantasie e trame per soddisfare le più varie esigenze di arredo. — Composed by polypropylene, these rugs are washable, long-lasting and many patterns are available to meet a wide range of furnishing needs.

- Due differenti tipologie di bordo sul lato corto: bordo chiuso e bordo con frange.

Two different low edge types: sewn and fringes.

- Possibilità di realizzare tappeti con dimensioni e colori personalizzati.

Possibility to create customized rugs in sizes and colors.

PATCHWALL

Design by Chiaramonte—Marin



Scansiona e scopri i progetti.
Scan and discover the projects.

2040
Fioriera alta
Tall flower box



2041
Fioriera media
Medium flower box



2042
Fioriera bassa
Short flower box



PRODOTTI—PRODUCTS



Codice/Code Tipologia/Typology	Disegno/Drawing	Info
2040 Fioriera alta Tall flower box W21 - D32 - H87,5 Kg 13,2		
2041 Fioriera media Medium flower box W83,5 - D32 - H64 Kg 22,6		
2042 Fioriera bassa Short flower box W83,5 - D32 - H25 Kg 11,8		

COLORI STRUTTURA—FRAME COLORS

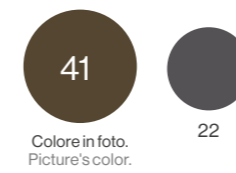

PLUS

- Struttura: acciaio verniciato, lamiera pre zincata a caldo verniciata.
Frame: painted steel, pre hot-dip zincated sheet.
- Sottopiedi regolabili.—Adjustable feet.
- Drenaggio acqua.—Water drainage.

RE-TROUVÉ

Design by Patricia Urquiola



Scansiona e scopri i progetti.
Scan and discover the projects.

577+580
Vaso alto
Tall vase



Vaso in ceramica con foro scolo acqua.
Ceramic vase with bottom hole for water drainage.

578+580
Vaso basso
Short vase

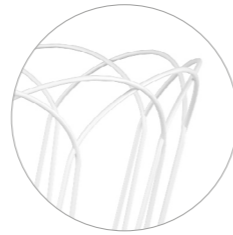

Tondino di acciaio zincato piegato con macchine a controllo numerico, per una maggiore precisione ed un migliore controllo del processo produttivo.
Hot-dip zincated steel bar bent with numerical control machines for a more precise and accurate manufacturing process.

PRODOTTI—PRODUCTS



Codice/Code Tipologia/Typology	Disegno/Drawing	Info
-----------------------------------	-----------------	------

577

Vaso alto
Tall vase
ø72 - H105
Kg 9,4

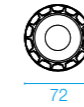
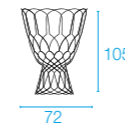

578

Vaso basso
Short vase
ø65 - H71
Kg 7,4

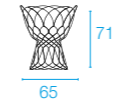

COLORI STRUTTURA—FRAME COLORS



Colore in foto.
Picture's color.

Codice/Code Tipologia/Typology	Info	Colori Colors
-----------------------------------	------	------------------

580

Fioriera—Flower box
x cod. 577, 578
ø60 - H37 Kg 15,0



23

RED CARPET

Design by EMU D&S Lab



Scansiona e scopri i progetti.
Scan and discover the projects.

3001
Tappeto
Rug



3002
Tappeto
Rug



PRODOTTI—PRODUCTS



Codice/Code Tipologia/Typology	Disegno/Drawing	Info
-----------------------------------	-----------------	------

3001

Tappeto
Rug

W200 - D300 - H1
Kg 12,0



3002

Tappeto
Rug

W300 - D400 - H1
Kg 24,0



COLORI TAPPETO/BORDO—RUG/BORDER COLORS

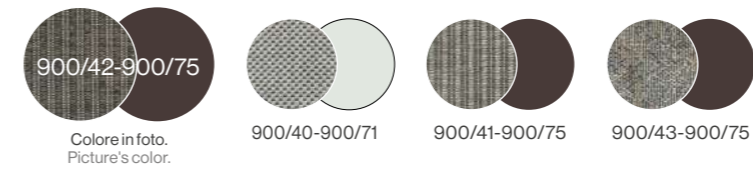

Le immagini dei colori sono a scopo illustrativo. Per vedere la trama dei Tessuti Tappeti consultare pg. 430.
All picture's colors are for illustration purposes only. Look at pg. 430 to see the texture of the Rugs Fabrics.



900/42-900/75

900/40-900/71

900/41-900/75

900/43-900/75

PLUS

- Realizzati in polipropilene, questi tappeti sono lavabili, duraturi e disponibili in diverse fantasie per soddisfare le più varie esigenze di arredo.—Composed by polypropylene, these rugs are washable, long-lasting and many patterns are available to meet a wide range of furnishing needs.
- Due dimensioni disponibili.—Two sizes available.
- Bordi in tessuto EMU che ne caratterizzano il design e favoriscono il mix&match con altre collezioni multimateriale.—The EMU fabric edges feature this design and enhance mix&match with other multimaterial collections.

COVER PER COLLEZIONI

COVER FOR COLLECTION

Collezione Collection	Cod.	Tipologia Typology	FC/295	FC/729	FC/730	FC/731	FC/742	FC/743	FC/744	FC/745	FC/763	FC/764	FC/980	FC/981	FC/982	FC/1045	FC/1085	FC/1210	FC/1216	FC/1219	FC/6047	
ANGEL	9042	Poltroncina Armchair																•				
	9045	Poltrona Lounge chair		•																		
	9046	Divano 2 posti 2-Seater sofa			•																	
ATHENA	3416	Poltrona Lounge chair																	•			
	3417	Divano 2 posti 2-Seater sofa																		•		
CABLA	5036 +5038 +5039	Poltrona Lounge chair		•																		
	5037	Poltrona Lounge chair																		•		
	(2x)5036 +5038 +5039	Divano 2 posti 2-Seater sofa			•																	
	(3x)5036 +5038 +5039	Divano 3 posti 3-Seater sofa																			•	
CANNOLÈ	1080	Poltrona Lounge chair		•																		
	1082 +1083	Divano 2 posti 2-Seater sofa					•															
	1081 +1082 +1083	Divano 3 posti 3-Seater sofa						•														
	1085	Pouf															•					
CAROUSEL	1212	Poltroncina Armchair																	•			
	1213	Poltroncina Armchair																	•			
	1214	Poltroncina Armchair																	•			
	1216	Poltrona Lounge chair																		•		
	1217	Poltrona Lounge chair																		•		
	1218	Poltrona Lounge chair																		•		
	1219	Divano 2 posti 2-Seater sofa																			•	

Collezione Collection	Cod.	Tipologia Typology	FC/295	FC/729	FC/730	FC/731	FC/742	FC/743	FC/744	FC/745	FC/763	FC/764	FC/980	FC/981	FC/982	FC/1045	FC/1085	FC/1210	FC/1216	FC/1219	FC/6047	
COMO	1200	Sedia Chair																	•			
	1201	Poltroncina Armchair																	•			
	1202	Poltroncina Armchair																	•			
	1204	Poltrona Lounge chair																		•		
	1205	Divano 2 posti 2-Seater sofa																			•	
DARWIN	524	Poltrona Lounge chair																		•		
	527	Divano 2 posti 2-Seater sofa																			•	
HOLLY	195	Lettino Sunbed	•																			
LYZE	615	Sedia Chair																		•		
	616	Poltroncina Armchair																		•		
	617	Poltrona Lounge chair																		•		
MOM	639	Sedia Chair																		•		
	640	Poltroncina Armchair																		•		
RIVIERA	434	Sedia Chair																		•		
	435	Poltroncina Armchair																		•		
	437	Poltrona Lounge chair																			•	
ROUND	465	Sedia Chair																		•		
	466	Poltroncina Armchair																		•		

COVER PER COLLEZIONI

COVER FOR COLLECTION

Collezione Collection	Cod.	Tipologia Typology	FC/295	FC/729	FC/730	FC/731	FC/742	FC/743	FC/744	FC/745	FC/763	FC/764	FC/980	FC/981	FC/982	FC/1045	FC/1085	FC/1210	FC/1216	FC/1219	FC/6047	
SHINE	247	Sedia Chair																				
	248	Poltroncina Armchair																				
	249	Poltrona Lounge chair																				
	260	Divano 2 posti 2-Seater sofa																				
	295	Lettino Sunbed	•																			
	6295	Lettino teak Teak sunbed	•																			
TAMI	763	Poltrona Lounge chair									•											
	764	Divano 2 posti 2-Seater sofa										•										
	765	Divano 3 posti 3-Seater sofa						•														
TERRAMARE	728	Poltroncina Armchair																				
	729	Poltrona Lounge chair		•																		
	730	Divano 2 posti 2-Seater sofa			•																	
	731	Divano 3 posti 3-Seater sofa				•																

Collezione Collection	Cod.	Tipologia Typology	FC/295	FC/729	FC/730	FC/731	FC/742	FC/743	FC/744	FC/745	FC/763	FC/764	FC/980	FC/981	FC/982	FC/1045	FC/1085	FC/1210	FC/1216	FC/1219	FC/6047	
TIKI	198	Lettino Sunbed	•																			
TREVI	995	Ombrellone 3x3 3x3 Sunshade												•								
	996	Ombrellone 4x3 4x3 Sunshade												•								
	997	Ombrellone 3,5x3,5 3,5x3,5 Sunshade												•								
TWINS	6040	Sedia Chair																				
	6051	Poltroncina Armchair																	•			
	6041	Poltroncina Armchair																		•		
	6042	Poltrona Lounge chair																		•		
	6045	Divano 1 posto 1-Seater sofa																				
	6046	Divano 2 posti 2-Seater sofa																				
	6047	Divano 3 posti 3-Seater sofa																				
6056	Divano 2 posti 2-Seater sofa																					
YARD	504	Lettino Sunbed	•																			



CUSCINI CUSHIONS

Realizzati con materiali altamente performanti ed estremamente resistenti agli agenti atmosferici, i cuscini EMU sono facilmente sfoderabili e lavabili, idrorepellenti, antiscivolo, con vari sistemi di fissaggio e adattabili a diverse tipologie di seduta. Disponibili in varie forme, colori, varietà di trame, motivi e texture, permettono di offrire massimo comfort e creare eleganti soluzioni di arredo.

Manufactured with highly performant and extremely weather-resistant materials, EMU cushions are easily removable and washable, water-repellent, non-slip, with various fastening systems and suitable for different types of seating. Available in multiple shapes, colors, weaves, patterns and textures, they offer maximum comfort and create elegant furnishing solutions.

INDEX

- 368 DECORATIVE CUSHIONS
- 370 EMU CUSHIONS
- 371 MAGNETIC CUSHIONS
- 372 UNIVERSAL CUSHIONS

DECORATIVE CUSHIONS

Design by EMU D&S Lab



Codice/Code Tipologia/Typology	Info	Colori Colors	Categoria tessuto Fabric category
C/701 Cuscino decorativo—Decorative cushion W40 - D40 - H15 Kg 0,7			Tessuti Basic (Vedi riepilogo pg. 369) Tessuti Standard (Vedi riepilogo pg. 369) Tessuti Exclusive (Vedi riepilogo pg. 369) Basic Fabrics (Look at pg. 369) Standard Fabrics (Look at pg. 369) Exclusive Fabrics (Look at pg. 369)
C/705 Cuscino decorativo—Decorative cushion W45 - D35 - H15 Kg 0,7			
C/706 Cuscino decorativo—Decorative cushion W60 - D40 - H20 Kg 0,9			

CUSCINI DECORATIVI PER COLLEZIONI—DECORATIVE CUSHIONS FOR COLLECTION

Collezione Collection	Cod.	Tipologia Typology				Collezione Collection	Cod.	Tipologia Typology				
			C/701	C/705	C/706				C/701	C/705	C/706	
ANGEL	9045	Poltrona Lounge chair	•	•	•	IVY	585	Poltrona Lounge chair	•	•	•	
	9046	Divano Sofa	•	•	•		586	Divano Sofa	•	•	•	
ATHENA	3416	Poltrona Lounge chair	•	•	•	NEF	627	Poltrona Lounge chair	•	•	•	
	3417	Divano Sofa	•	•	•		628	Poltrona Lounge chair	•	•	•	
CABLA	5036	Poltrona Lounge chair	•	•	•	REEL	180	Dondolo divano Rocking sofa	•	•	•	
	5037	Chaise Lounge	•	•	•	ROUND	469	Poltrona Lounge chair	•	•	•	
CANNOLÈ	1080	Poltrona Lounge chair	•	•	•	TAMI	763	Struttura poltrona Lounge chair frame	•	•	•	
	1081	Modulo lineare Straight module	•	•	•		764	Struttura divano 2 posti 2-Seater sofa frame	•	•	•	
	1082	Modulo terminale dx Right end module	•	•	•		765	Struttura divano 3 posti 3-Seater sofa frame	•	•	•	
	1083	Modulo terminale sx Left end module	•	•	•		769	Struttura angolare Angular frame	•	•	•	
	1084	Modulo angolare Corner module	•	•	•	TERRAMARE	729	Struttura poltrona Lounge chair frame	•	•	•	
CAROUSEL	1216	Poltrona Lounge chair	•	•	•		730	Struttura divano 2 posti 2-Seater sofa frame	•	•	•	
	1217	Poltrona Lounge chair	•	•	•		731	Struttura divano 3 posti 3-Seater sofa frame	•	•	•	
	1218	Poltrona Lounge chair	•	•	•	TWINS	6045	Divano 1 posto Alu-Teak 1-Seater Alu-Teak sofa	•	•	•	
	1219	Divano Sofa	•	•	•		6046	Divano 2 posto Alu-Teak 2-Seater Alu-Teak sofa	•	•	•	
COLLIER	1352	Poltrona Lounge chair	•	•	•		6047	Divano 3 posto Alu-Teak 3-Seater Alu-Teak sofa	•	•	•	
	COMO	1204	Poltrona Lounge chair	•	•		•	6055	Divano 1 posto Teak 1-Seater Teak sofa	•	•	•
		1205	Divano Sofa	•	•		•	6056	Divano 2 posto Teak 2-Seater Teak sofa	•	•	•
HEAVEN	487	Poltrona Lounge chair	•	•	•	6057	Divano 3 posto Teak 3-Seater Teak sofa	•	•	•		

TESSUTI CUSCINI DECORATIVI C/701 - C/705 - C/706 DECORATIVE CUSHIONS FABRICS C/701 - C/705 - C/706

Composizione/Categoria tessuti Composition/Fabrics category	Colori Colors
TESSUTI BASIC—BASIC FABRICS	
Acrilico—Acrylic	
TESSUTI STANDARD—STANDARD FABRICS	
88% Acrilico, 12% Poliestere—88% Acrylic, 12% Polyester	
TESSUTI EXCLUSIVE—EXCLUSIVE FABRICS	
CAT. E Visitare il nostro sito web www.emu.it —Visit our website www.emu.it	
CAT. D Visitare il nostro sito web www.emu.it —Visit our website www.emu.it	
CAT. C Visitare il nostro sito web www.emu.it —Visit our website www.emu.it	
CON TESSUTO CLIENTE—WITH CUSTOMER'S FABRIC	
FABBISOGNO TESSUTO (cm)—FABRIC REQUIRED (cm)	C/701 132x40, C/705 132x40, C/706 132x60

I CUSCINI DECORATIVI HANNO LA FODERA INTERNA IN POLIESTERE

Fodera utilizzata solo per i cuscini decorativi. Si tratta di una fodera in poliestere che contiene l'imbottitura interna senza garantire nessuna protezione all'acqua ma al solo scopo contenitivo.

DECORATIVE CUSHIONS HAVE A POLYESTER INNER LINING

Lining only used for decorative cushions. This polyester is not waterproof but only has a containing function of the inner padding.

Collezione Collection	Cod.	Tipologia Typology	Cuscini con tessuti Basic Cushion with Basic fabric		Cuscini con tessuti Standard e Exclusive Cushion with Standard and Exclusive fabric	
			NON ha fodera interna, solo imbottitura NO inner lining, only padding	Fodera in poliestere Polyester lining	NON ha fodera interna, solo imbottitura NO inner lining, only padding	Fodera in poliestere Polyester lining
DECORATIVE CUSHIONS	C/701	Cuscino quadrato Square cushion		•		•
	C/705	Cuscino rettangolare piccolo Small rectangular cushion		•		•
	C/706	Cuscino rettangolare grande Big rectangular cushion		•		•

EMU CUSHIONS

Design by EMU D&S Lab



Codice/Code Tipologia/Typology	Info	Colori Colors	Categoria tessuto Fabric category
C/703 Cuscino EMU acrilico quadrato Acrylic EMU square cushion W38 - D38 - H2 Kg 0,17		700/4	Tessuti Basic Basic Fabrics
		700/10	
		700/13	
		700/32	
		700/34	
C/704 Cuscino EMU acrilico tondo Acrylic EMU round cushion ø38,5 - H2 Kg 0,13		700/4	Tessuti Basic Basic Fabrics
		700/10	
		700/13	
		700/32	
		700/34	

CUSCINI EMU PER COLLEZIONI — EMU CUSHIONS FOR COLLECTION

Collezione Collection	Cod.	Tipologia Typology	C/703	C/704
CAPRERA	930	Sedia Chair		•
	931	Poltroncina Armchair		•
COUPOLE	440	Sedia Chair		•
	442	Sgabello Barstool		•
MIA	410	Sedia Chair	•	
	411	Poltroncina Armchair	•	
	412	Sgabello Barstool	•	
PIGALLE	909	Sedia Chair		•
	910	Poltroncina Armchair		•
	924	Sedia pieghevole Folding chair		•
SEGNO	263	Sedia Chair	•	
	264	Sgabello Barstool	•	
	267	Poltroncina Armchair	•	
	268	Poltroncina Armchair	•	

Collezione Collection	Cod.	Tipologia Typology	C/703	C/704
SOLE	3402	Sedia Chair		•
	3403	Poltroncina Armchair		•
STAR	161	Sedia Chair	•	
	162	Poltroncina Armchair	•	
	164	Sgabello Barstool	•	
	1361	Sedia Chair	•	
URBAN	208	Sedia Chair	•	
	209	Poltroncina Armchair	•	

CARATTERISTICHE CUSCINI EMU — EMU CUSHIONS CHARACTERISTICS

Collezione Collection	Cod.	Tipologia Typology	Cuscini con tessuti Basic Cushion with Basic fabric	
			NON ha fodera interna, solo imbottitura NO inner lining, only padding	Fodera in poliestere Polyester lining
EMU CUSHIONS	C/703	Cuscino EMU quadrato EMU square cushion		•
	C/704	Cuscino EMU tondo EMU round cushion		•

MAGNETIC CUSHIONS

Design by Chiaramonte—Marin



Codice/Code Tipologia/Typology	Info	Colori Colors	Categoria tessuto Fabric category
C/714 Cuscino magnetico poliestere quadrato Polyester square magnetic cushion W39 - D37 - H1,5 Kg 0,23		500/32	Tessuti Cuscini Contract Contract Cushions Fabrics
		500/33	
		500/34	
		500/35	
		500/36	
C/715 Cuscino magnetico poliestere tondo Polyester round magnetic cushion ø35,5 - H1,5 Kg 0,15		500/32	Tessuti Cuscini Contract Contract Cushions Fabrics
		500/33	
		500/34	
		500/35	
		500/36	
C/717 Cuscino magnetico poliestere rettangolare Polyester rectangular magnetic cushion W40 - D28 - H1,5 Kg 0,18		500/32	Tessuti Cuscini Contract Contract Cushions Fabrics
		500/33	
		500/34	
		500/35	
		500/36	
C/718 Cuscino magnetico poliestere poltrona Polyester lounge chair magnetic cushion W53 - D44 - H1,5 Kg 0,34		500/32	Tessuti Cuscini Contract Contract Cushions Fabrics
		500/33	
		500/34	
		500/35	
		500/36	

CUSCINI MAGNETICI PER COLLEZIONI — MAGNETIC CUSHIONS FOR COLLECTION

Collezione Collection	Cod.	Tipologia Typology	C/714	C/715	C/717	C/718
ALA	150	Sedia Chair	•			
	151	Poltroncina Armchair	•			
ARCENCIEL	314	Sedia Chair			•	
CAPRERA	930	Sedia Chair		•		
	931	Poltroncina Armchair		•		
COUPOLE	440	Sedia Chair		•		
	442	Sgabello Barstool		•		
PIGALLE	909	Sedia Chair		•		
	910	Poltroncina Armchair		•		
	924	Sedia pieghevole Folding chair		•		
RIOR50	790	Sedia Chair	•			
	791	Poltroncina Armchair	•			
	793	Sgabello Barstool			•	
	792	Poltrona Lounge chair				•
	795	Poltrona dondolo Rocking chair				•
SEGNO	263	Sedia Chair	•			
	264	Sgabello Barstool	•			
	268	Poltroncina Armchair	•			
SOLE	3402	Sedia Chair		•		
	3403	Poltroncina Armchair		•		
STAR	161	Sedia Chair	•			
	162	Poltroncina Armchair	•			
	164	Sgabello Barstool	•			
	165	Poltrona Lounge chair				•
	166	Divano Sofa				•
THOR	655	Sedia Chair		•		
	657	Sgabello Barstool		•		
	658	Sgabello basso Dining stool		•		

UNIVERSAL CUSHIONS (Water-repellent fabrics)

Design by EMU D&S Lab



Codice/Code Tipologia/Typology	Info	Colori Colors	Categoria tessuto Fabric category
C/707 Cuscino universale poliester Polyester universal cushion W45 - D39 - H1,5 Kg 0,25		500/32	Tessuti Cuscini Contract Contract Cushions Fabrics
		500/33	
		500/34	
		500/35	
		500/36	
C/708 Cuscino universale poliester Polyester universal cushion W43 - D43 - H1,5 Kg 0,22		500/32	Tessuti Cuscini Contract Contract Cushions Fabrics
		500/33	
		500/34	
		500/35	
		500/36	
C/709 Cuscino universale poliester Polyester universal cushion W37,5 - D37,5 - H1,5 Kg 0,20		500/32	Tessuti Cuscini Contract Contract Cushions Fabrics
		500/33	
		500/34	
		500/35	
		500/36	
C/716 Cuscino universale poliester Polyester universal cushion W38 - D40 - H1,5 Kg 0,24		500/32	Tessuti Cuscini Contract Contract Cushions Fabrics
		500/33	
		500/34	
		500/35	
		500/36	

CUSCINI UNIVERSALI PER COLLEZIONI — UNIVERSAL CUSHIONS FOR COLLECTION

Collezione Collection	Cod.	Tipologia Typology					Collezione Collection	Cod.	Tipologia Typology				
DARWIN	521	Sedia Chair	•				SEGNO	263	Sedia Chair				•
	522	Poltroncina Armchair	•					264	Sgabello Barstool				
GRACE	280	Sedia Chair	•					268	Poltroncina Armchair				
	281	Poltroncina Armchair	•				STAR	161	Sedia Chair				•
MIA	410	Sedia Chair			•	•		162	Poltroncina Armchair				•
	411	Poltroncina Armchair			•	•		164	Sgabello Barstool				•
	412	Sgabello Barstool			•	•		1361	Sedia Chair				•
MOM	639	Sedia Chair		•			1362	Poltroncina Armchair				•	
	640	Poltroncina Armchair		•			THOR	655	Sedia Chair			•	
RIOR50	790	Sedia Chair				•		657	Sgabello Barstool			•	
	791	Poltroncina Armchair				•		658	Sgabello basso Dining barstool			•	
RIVIERA	434	Sedia Chair				•	URBAN	208	Sedia Chair				•
	435	Poltroncina Armchair				•		209	Poltroncina Armchair				•
ROUND	465	Sedia Chair	•										
	466	Poltroncina Armchair	•										

CARATTERISTICHE CUSCINI CUSHIONS CHARACTERISTICS

CARATTERISTICHE TESSUTO ESTERNO DEL CUSCINO

La gamma dei tessuti, che costituiscono la cover esterna, comprende diverse composizioni e diversi trattamenti superficiali che comportano differenti caratteristiche, descritte nelle rispettive schede tecniche.

Verificare i tessuti previsti e le relative schede tecniche nel sito www.emu.it

CARATTERISTICHE FODERA INTERNA IN TESSUTO

Per fodera interna si intende il tessuto che racchiude l'imbottitura. Tale fodera è impermeabile, ossia realizzata con tessuto trattato per resistere alla penetrazione dell'acqua. Questo tipo di trattamento è il massimo grado di protezione dall'acqua per i tessuti, ma sopra una determinata pressione comunque l'acqua può penetrare nel cuscino. Si consiglia quindi di proteggere sempre i cuscini dalla pioggia con le apposite cover e, se bagnati, di sfoderarli (cover esterna) e lasciarli asciugare all'aria e al sole.

CHARACTERISTICS OF THE EXTERNAL CUSHION'S FABRIC

The fabrics range for the external cover includes various compositions and surface treatments involving various characteristics, described in the respective datasheets.

Check the required fabrics and associated datasheets at www.emu.it.

CHARACTERISTICS OF THE FABRIC INNER LINING

The inner lining is the fabric that encloses the padding. This lining is waterproof, it means that the inner cushion cover is made of treated fabric to withstand the flow of water. This type of treatment is the highest degree of water protection for fabric, but above some pressure water may still penetrate the cushion. It is therefore recommended to always protect the cushions from the rain with their own covers and, if wet, remove the covers (external cover) and leave them out to air and sun dry.

Collezione Collection	Cod.	Tipologia Typology	Cuscini con tessuti Basic Cushion with Basic fabrics		Cuscini con tessuti Standard e Exclusive Cushion with Standard and Exclusive fabrics	
			NON ha fodera interna, solo imbottitura NO inner lining, only padding	Fodera interna impermeabile Waterproof inner lining	NON ha fodera interna, solo imbottitura NO inner lining, only padding	Fodera interna impermeabile Waterproof inner lining
ALA	C/152*	Cuscino seduta Seat cushion	•			
ANGEL	C/9042*	Cuscino seduta Seat cushion	•		•	
	C/9045*	Cuscino seduta e schienale Seat and back cushion		•		•
	C/9044*	Cuscino bracciolo Armrest cushion		•		•
	C/9046*	Cuscino seduta e schienale Seat and back cushion		•		•
APER0	C/1300*	Cuscino seduta Seat cushion	•		•	
ATHENA	C/3400*	Cuscino seduta Seat cushion	•			
	C/3416*	Cuscino seduta e schienale Seat and back cushion		•		
	C/3417*	Cuscino seduta e schienale Seat and back cushion		•		
CABLA	C/5036*	Cuscino seduta e schienale Seat and back cushion		•		•
	C/5037*	Cuscino seduta e schienale Seat and back cushion		•		•
	C/5038*	Cuscino bracciolo dx Right armrest cushion		•		•
	C/5039*	Cuscino bracciolo sx Left armrest cushion		•		•
CANNOLE	C/1080*	Cuscino seduta Seat cushion		•		•
	C/1081*	Cuscino schienale Back cushion		•		•
	C/1082*	Cuscino bracciolo dx Right armrest cushion		•		•
	C/1083*	Cuscino bracciolo sx Left armrest cushion		•		•
	C/1084*	Cuscino schienale angolare Corner back cushion		•		•
	C/1085*	Cuscino seduta angolare Corner seat cushion		•		•
CAROUSEL	C/1211*	Cuscino seduta Seat cushion		•		•
	C/1215*	Cuscino seduta Seat cushion		•		•
	C/1219*	Cuscino seduta Seat cushion		•		•
	C/1222*	Cuscino seduta Seat cushion		•		•
COMO	C/1200*	Cuscino seduta Seat cushion		•		•
	C/1201*	Cuscino schienale Back cushion		•		•
	C/1204*	Cuscino seduta Seat cushion		•		•
	C/1205*	Cuscino seduta Seat cushion		•		•
COLLIER	C/1250*	Cuscino seduta e schienale Seat and back cushion	•			
	C/1252*	Cuscino seduta e schienale Seat and back cushion	•			
C/1350*	C/1350*	Cuscino seduta Seat cushion		•		•
	C/1351*	Cuscino schienale Back cushion		•		•
	C/1352*	Cuscino seduta Seat cushion		•		•
	C/1353*	Cuscino schienale Back cushion		•		•

* Cuscini sfoderabili (fodera esterna in tessuto). — Removable external cover.

Collezione Collection	Cod.	Tipologia Typology	Cuscini con tessuti Basic Cushion with Basic fabrics		Cuscini con tessuti Standard e Exclusive Cushion with Standard and Exclusive fabrics	
			NON ha fodera interna, solo imbottitura NO inner lining, only padding	Fodera interna impermeabile Waterproof inner lining	NON ha fodera interna, solo imbottitura NO inner lining, only padding	Fodera interna impermeabile Waterproof inner lining
DARWIN	C/521*	Cuscino seduta Seat cushion	•			
	C/524*	Cuscino seduta Seat cushion	•			
	C/527*	Cuscino seduta Seat cushion	•			
HEAVEN	C/485*	Cuscino seduta e schienale Seat and back cushion			•	
	C/486*	Cuscino seduta e schienale Seat and back cushion			•	
	495/S*	Cuscino seduta imbottito Padded seat cushion			•	
IVY	C/585*	Cuscino seduta e schienale Seat and back cushion				•
	C/586*	Cuscino seduta e schienale Seat and back cushion				•
LYZE	C/615	Cuscino seduta Seat cushion			•	
	C/616	Cuscino seduta e schienale Seat and back cushion			•	
	C/617	Cuscino seduta e schienale Seat and back cushion			•	
MOM	C/640*	Cuscino seduta Seat cushion	•			
	C/641*	Cuscino schienale Back cushion	•			
NEF	C/626*	Cuscino seduta Seat cushion			•	
	C/627*	Cuscino seduta e schienale Seat and back cushion				•
	S/626	Cuscino schienale Back cushion			•	
RE-TROUVÉ	C/566*	Cuscino seduta e schienale Seat and back cushion			•	
	C/575*	Cuscino seduta Seat cushion			•	
REEL	C/180*	Cuscino seduta e schienale Seat and back cushion				
RIVIERA	C/434*	Cuscino seduta Seat cushion			•	
	C/437*	Cuscino seduta Seat cushion			•	
RONDA	C/116*	Cuscino seduta e schienale Seat and back cushion	•			
	C/116S*	Cuscino seduta Seat cushion	•			
ROUND	C/468*	Cuscino intero Whole cushion			•	
	C/469*	Cuscino seduta e schienale Seat and back cushion			•	
SHINE	C/247*	Cuscino seduta Seat cushion			•	
	C/249*	Cuscino seduta Seat cushion			•	
STAR	C/161*	Cuscino seduta Seat cushion	•			
	C/162*	Cuscino schienale Back cushion	•			
TAMI	C/770*	Cuscino seduta Seat cushion		•		•
	C/771*	Cuscino schienale Back cushion		•		•
	C/772*	Cuscino bracciolo Armrest cushion		•		•
	C/773*	Cuscino decorativo Decorative cushion		•		•
TERRA	C/721*	Cuscino seduta Seat cushion		•		•
TERRAMARE	C/729*	Cuscino seduta e schienale Seat and back cushion		•		•
TWINS	C/6051*	Cuscino seduta Seat cushion	•		•	
	C/6052*	Cuscino seduta e schienale Seat and back cushion	•		•	
	C/6053*	Cuscino seduta e schienale Seat and back cushion	•		•	
	C/6055*	Cuscino seduta e schienale Seat and back cushion		•		•
	C/6056*	Cuscino seduta e schienale dx Dx seat and back cushion		•		•
	C/6057*	Cuscino seduta e schienale sx Sx seat and back cushion		•		•
	C/6047*	Cuscino seduta e schienale centrale Middle seat and back cushion		•		•

CURA, MANUTENZIONE E AVVERTENZE CUSCINI EMU CARE, MAINTENANCE AND WARNINGS EMU CUSHIONS

All'interno dell'imballo dei cuscini, uno per ogni imballo, e downloadabile dal sito, c'è una scheda "Cuscini EMU: cura, manutenzione e avvertenze". Questo documento è la fonte ufficiale EMU che contiene le indicazioni di corretta manutenzione.

- Il contatto prolungato con sostanze grasse e/o coloranti può provocare macchie permanenti e deteriorare la struttura del filato. È necessario rimuovere immediatamente tali sostanze prima che arrivino in contatto con la fodera interna.
- In caso di utilizzo vicino al mare o piscine si consiglia un lavaggio periodico.
- Estrarre con delicatezza l'imbottitura utilizzando l'apposita cerniera prima di procedere al lavaggio. Porre particolare attenzione quando si estrae l'imbottitura dal cuscino, per agevolare l'operazione di rimozione piegare l'imbottitura su se stessa. Al termine del lavaggio della fodera, usando lo stesso sistema, reinserire l'imbottitura con cura.
- Prima di avviare il lavaggio, chiudere le zip e chiudere tutti i sistemi di fissaggio in Velcro® facendo aderire le due componenti del Velcro® come se si stesse chiudendo o fissando il cuscino, così da prevenire ogni rischio di danneggiamento del tessuto. Per i cuscini seduta Tami C/770, si consiglia di conservare la protezione in Velcro® apposta sul lembo di fissaggio al momento in cui si riceve il cuscino nuovo imballato e di applicare tale protezione sul lembo stesso quando si effettua il lavaggio della fodera esterna.
- Evitare di lavare fodere di colori differenti nella stessa sessione di lavaggio.
- Lavaggio: seguire le istruzioni specifiche per ogni materiale riportate sull'apposita etichetta. Utilizzare acqua e detersivi liquidi non abrasivi con PH neutro e incolore. Eventualmente lasciare agire il detersivo alcuni minuti. Non usare ammorbidente. Sciacquare abbondantemente con acqua a temperatura non superiore a 30°C. Nel caso di utilizzo di dispositivi a pressione, tenere la punta del diffusore ad una distanza di almeno 60/70 cm dalla superficie del manufatto. Se necessario ripetere l'operazione. Non utilizzare spugne abrasive per smacchiare e non trattare con candeggina e cloro. Asciugare in modo naturale. Non reinserire l'imbottitura prima della completa asciugatura della fodera.
- Se il cuscino è esposto a pioggia o viene accidentalmente bagnato, si consiglia di metterlo in posizione e zona arieggiate per facilitarne l'asciugatura. In caso in cui la condizione sia più severa, ripetere la stessa operazione ma estraendone l'imbottitura interna, per accelerare il processo di asciugatura.
- Nel caso di periodi di prolungato inutilizzo e/o di rimessaggio invernale dei cuscini, sconsigliamo di utilizzare cover impermeabili per coprire i cuscini e di assicurarsi che gli stessi siano riposti in luoghi arieggiati ed asciutti e rialzati da terra onde prevenire muffe causate dalla condensa di umidità.
- Prima di riporre il prodotto per la stagione di inutilizzo assicurarsi che questo sia completamente asciutto e pulito.
- Tutti i tessuti possono subir un naturale viraggio di colore a seguito di un'esposizione prolungata al sole; tale effetto è da considerarsi normale e varia da tessuto a tessuto.

Inside the packaging of the cushions, one for each package, and downloadable from the website, there is a specific data sheet "EMU cushions: care, upkeep and warnings". This document is the official EMU document for the correct maintenance.

- Prolonged contact with greasy substances and/or dyes can cause permanent stains and deterioration of the yarn structure. It is necessary to remove such substances immediately before they come into contact with the inner lining.
- Cushions used near the seaside or near a swimming pool require more frequent cleaning.
- Carefully remove the padding using the zip before washing. Pay particular attention to removing the cover from the cushion, and fold the cover back on itself to facilitate the process of removal. After having cleaned the cover, reinsert it using the same method.
- Before starting washing, close the zips and close all Velcro® fasteners by adhering the two Velcro® components as if you were closing or fastening the cushion in order to prevent any risk of damage to the fabric. For Tami C/770 seat cushions, it is recommended to keep the Velcro® protection on the fastening flap when you receive the cushion in its new packaging and to apply the Velcro® to the cushion.
- Avoid washing linings of different colors in the same washing session.
- Washing: follow the material-specific instructions on the washing label. Use water and non-abrasive liquid detergents with a neutral and colorless PH. If required, let the detergent act for a few minutes. Do not use fabric softener. Rinse thoroughly with water at a temperature not exceeding 30°C. When using pressure devices, keep the tip of the diffuser at a distance of at least 60/70 cm from the surface of the item. If necessary, repeat the operation. Do not use abrasive sponges to remove stains and do not treat with bleach or chlorine. Dry naturally. Do not reinsert the upholstery until the cover is completely dry.
- If the cushion is exposed to rain or is accidentally wet, it is recommended to place it in an airy area to facilitate drying. If the condition is more severe, repeat the same operation but removing the inner padding to speed up the drying process.
- In case of prolonged periods of inactivity and/or winter storage of the cushions, we do not recommend using waterproof covers to cover the cushions.
- We recommend to ensure that they are placed in an airy and dry place and also raised off the ground to prevent mould caused by condensation of moisture.
- Make sure the product is completely dry and clean before storing it for the rest of the season.
- All textiles may undergo a natural color change following prolonged exposure to the sun, which is normal and varies from fabric to fabric.

MATERIALI

MATERIALS



METALLI—METALS

METALLI-MAGLIE METALLICHE
METALS-STEEL MESHES

MICROFIBRA
MICROFIBER

EMU MAGLIA SINTETICA
EMU SYNTHETIC MESH

EMU-TEX

ABS

CINGHIE ELASTICHE—ELASTIC BELTS

MATTONELLE—TILES

CORDE SINTETICHE
SYNTHETIC ROPES

CRISTALLO TEMPERATO
TEMPERED GLASS

GRES PORCELLANATO
PORCELAIN STONEWARE

HPL

LEGNI—WOODS

COVER

WPC

TESSUTI COPERTURE
SHADING FABRICS

TESSUTI BASIC—BASIC FABRICS

TESSUTI EXCLUSIVE—EXCLUSIVE FABRICS

TESSUTI CUSCINI CONTRACT
CONTRACT CUSHIONS FABRICS

ECO-CUOIO—ECO-LEATHER

TESSUTI STANDARD
STANDARD FABRICS

TESSUTI STAMPATI—PRINTED FABRICS

TESSUTI TAPPETI—RUGS FABRICS

METALLI—METALS

ACCIAIO - Lega di ferro e carbonio con percentuale di carbonio inferiore al 2% trattata per resistere agli agenti atmosferici con l'esclusivo processo anticorrosione EMU-Coat.

ALLUMINIO - Leghe di alluminio, particolarmente idonee per la lavorazione a freddo e per la pressofusione, trattate opportunamente per resistere agli agenti atmosferici e verniciate a polvere.

STEEL - Iron and carbon alloy, with carbon content below 2%, treated to withstand the elements with the unique EMU-Coat anticorrosion process.

ALUMINIUM - Aluminium alloys, particularly suitable for cold-working and for die-casting, appropriately treated to withstand the elements and powder coated.



METALLI-MAGLIE METALLICHE—METALS-STEEL MESHES



LAMIERA FINTO INTRECCIO
SIMULATED WOVEN WIRE MESH

LAMIERA FINTO INTRECCIO
SIMULATED WOVEN WIRE MESH

LAMIERA FORATA
PERFORATED METAL SHEET

LAMIERA FORATA
PERFORATED METAL SHEET

LAMIERA INTRECCIATA
WOVEN WIRE MESH

LAMIERA STIRATA
EXPANDED METAL SHEET

LAMIERA STIRATA
EXPANDED METAL SHEET

LAMIERA STIRATA
EXPANDED METAL SHEET

LAMIERA STIRATA
EXPANDED METAL SHEET

LAMIERA STIRATA
EXPANDED METAL SHEET

MICROFIBRA—MICROFIBER

Multifilamento 100% PES particolarmente resistente all'uso quotidiano, in aspetto nubuk, per una componentistica di alta qualità e durata, caratterizzata dalla tessitura di fibre di poliestere aventi titolo uguale o minore di 1 dtex.

100% PES multifilament material particularly resistant for daily use, in nubuck aspect, it has high quality and long-lasting components, characterized by the weaving of polyester fibers having a title equal to or less than 1 dtex.



500/10 AVANA
CHESNUT

500/11 NERO
BLACK

500/12 GRIGIO SCURO
DARK GREY

EMU MAGLIA SINTETICA—EMU SYNTHETIC MESH

Materiale composito costituito da PVC (45%), PP (40%) e PES (5%), e costruito tramite una maglia doppia in "Jacquard" a due fili, GG05, con caratteristiche adatte per uso esterno ed interno. L'unione dei due filati crea una "maglia sintetica" morbida al tatto, con alte qualità tecniche contro i microrganismi.

Composite material consisting of PVC (45%), PP (40%) and PES (5%), and constructed using a "Jacquard" double yarn in GG05 two-yarn, fit for out- and indoor use. The two united yarns create a "synthetic mesh" which is soft to the touch, with high technical qualities against microorganisms.

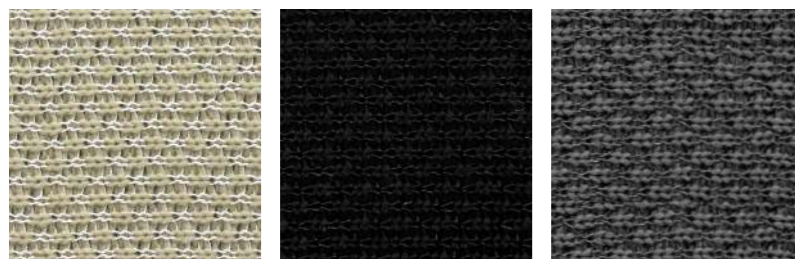

300/30 AVANA
CHESNUT

300/31 NERO
BLACK

300/32 GRIGIO SCURO
DARK GREY

EMU-TEX—EMU-TEX

È un tessuto tecnico per esterni realizzato con filo in polivinilcloruro. Ha caratteristiche di eccezionale robustezza a garanzia di una durata nel tempo: massima resistenza ai raggi ultravioletti, agli agenti atmosferici, all'umidità e agli sbalzi di temperatura.

It is a technical fabric for outdoor use made with polyvinyl chloride thread. It features exceptional strength to ensure durability: maximum resistance to UV rays, the elements, humidity and sudden changes in temperature.

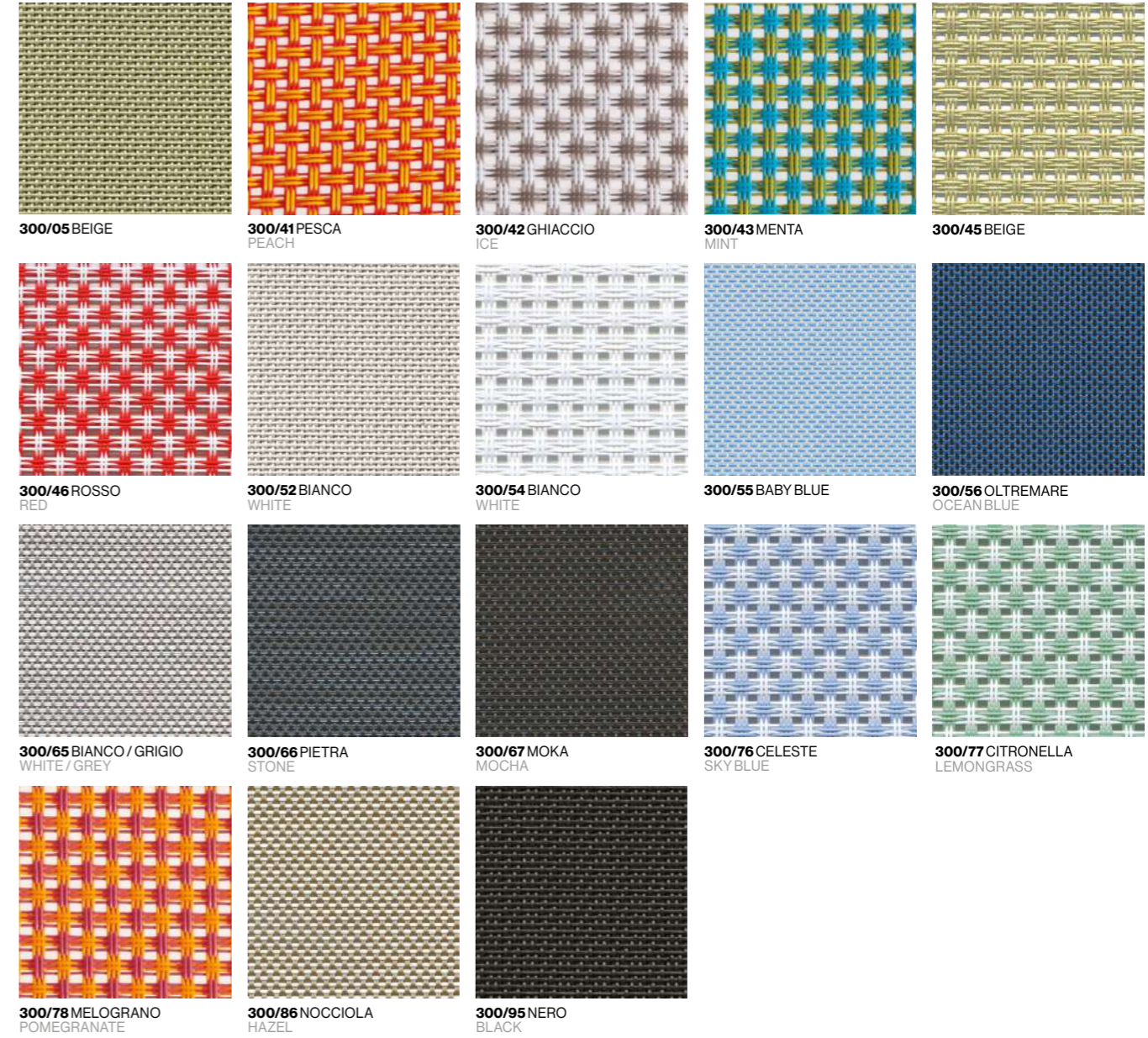

300/05 BEIGE

300/41 PESCA
PEACH

300/42 GHIACCIO
ICE

300/43 MENTA
MINT

300/45 BEIGE

300/46 ROSSO
RED

300/52 BIANCO
WHITE

300/54 BIANCO
WHITE

300/55 BABY BLUE

300/56 OLTREMARE
OCEAN BLUE

300/65 BIANCO / GRIGIO
WHITE / GREY

300/66 PIETRA
STONE

300/67 MOKA
MOCHA

300/76 CELESTE
SKY BLUE

300/77 CITRONELLA
LEMONGRASS

300/78 MELOGRANO
POMEGRANATE

300/86 NOCCIOLA
HAZEL

300/95 NERO
BLACK

ABS

L'ABS è un tecnopolimero termoplastico che, una volta stabilizzato, resiste bene alle radiazioni UV e quindi è impiegabile all'esterno. Presenta buone caratteristiche meccaniche anche a basse temperature e possiede un'elevata durezza, resistenza all'urto e alla scalfittura. Tali caratteristiche lo rendono ideale per impieghi in vari settori, fra cui quello dell'arredamento.

ABS is a thermoplastic techno-polymer that, once stabilised, well resists even against UV radiation and is therefore suitable to outdoor use. It maintains strong mechanical features even at low temperatures and has high strength, impact and scratch resistance. These features make it ideal for use in a range of sectors, including furnishing.

CIAK

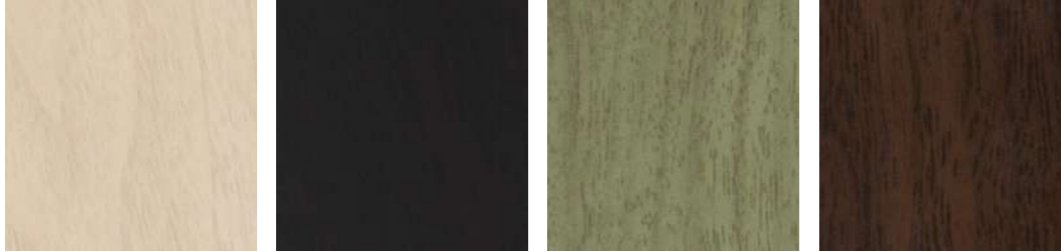

23 BIANCO
WHITE

24 NERO
BLACK

37 GRIGIO / VERDE
GREY / GREEN

41 MARRONE
BROWN

LUCIOLE

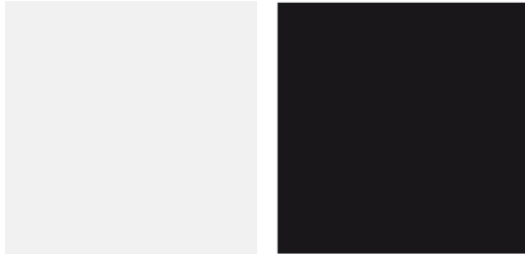

23 BIANCO
WHITE

24 NERO
BLACK

CINGHIE ELASTICHE — ELASTIC BELTS

Ottenute mediante la tessitura di materiali sintetici quali fibre di propilene (71%) e fili di gomma sintetica (29%), rendono il prodotto adatto all'uso esterno.

Obtained by weaving synthetic materials such as propylene fibres (71%) and synthetic rubber thread (29%), making the product suitable to outdoor use.



57 MARRONE
BROWN

62 GRIGIO / NERO
GREY / BLACK

64 GRIGIO / VERDE
GREY / GREEN

MATTONELLE — TILES



01 MATTONELLE CON SCARABEO
TILES WITH SCARAB

65 MATTONELLE CON PESCE
TILES WITH FISH

CORDE SINTETICHE — SYNTHETIC ROPES

Doppia treccia costruita con anima in poliestere e copertura in propilene multifilamento. La fibra esterna di cui è composta è impermeabile e resistente ai raggi UV.

Double braid with polyester core and multifilament propylene covering. The external fibre is waterproof and resistant to UV rays.

CAROUSEL



12 AVORIO MELANGIATO
MELANGE IVORY

18 GRIGIO MELANGIATO
MELANGE GREY

19 MARRONE MELANGIATO
MELANGE BROWN

NEF



30 GRIGIO SCURO
DARK GREY

31 NERO
BLACK

32 GRIGIO CHIARO
LIGHT GREY

REEL



98 BEIGE

CRISTALLO TEMPERATO — TEMPERED GLASS

Cristallo temperato in conformità con le normative internazionali BS 6206 e prodotto nel rispetto della normativa BS 7376.

Tempered glass compliant with international standards BS 6206 and produced compliant with standard BS 7376.

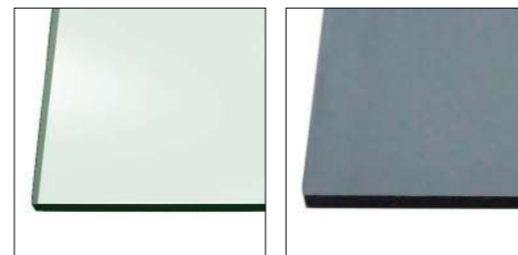

00 TRASPARENTE
TRANSPARENT

83 GRIGIO FUMÉ
SMOKY GREY

GRES PORCELLANATO—PORCELAIN STONEWARE

Il gres porcellanato, grazie alle sue eccellenti proprietà fisiche e meccaniche, è ideale per uso esterno, essendo inattaccabile dagli agenti atmosferici e inalterabile ai raggi UV. Le sue qualità gli permettono di essere idrorepellente e oleorepellente. Il gres porcellanato è ottenuto tramite il processo di sintetizzazione di argille ceramiche, feldspati, caolini e sabbia. Queste materie prime vengono macinate e atomizzate fino a ottenere una granulometria omogenea adatta alla pressatura. La cottura avviene a 1150-1250 °C per circa 25-30 minuti allo scopo di determinare la ceramizzazione dell'impasto attribuendone così le tipiche caratteristiche di resistenza alle abrasioni. Colori, venature e sfumature del gres porcellanato possono variare da pezzo a pezzo. Questa differenza dimostra il valore aggiunto, oltre all'unicità, del prodotto.

Thanks to its excellent physical and mechanical properties, porcelain stoneware is ideal for outdoor use, since it is resistant to atmospheric corrosion and unaffected by UV exposure. Its qualities allow it to be water-and-oil repellent. Porcelain stoneware is obtained via the synthesizing process of ceramic clay, feldspar, kaolin and sand. These raw materials undergo grinding and atomization until a homogeneous particle size, suitable for pressing, is obtained. Firing takes place at 1150-1250°C for approx. 25-30 minutes in order to determine the ceramization of the mixture, ensuring the typical resistance to abrasion. The colors, veins and shadings of porcelain stoneware vary from piece to piece. Such difference indicates the plus value and the uniqueness of the product.

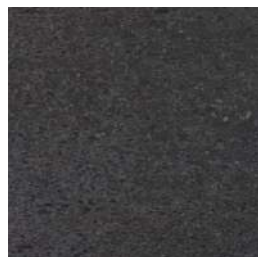

34 BASALTINA



35 BIANCO STATUARIO
STATUARIO WHITE



36 EMPERADOR



51 SALE
SALT



53 PIOMBO
LEAD

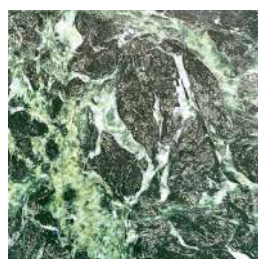

59 VERDE ALPI
ALPS GREEN

HPL

Materiale autoportante adatto all'esposizione all'ambiente esterno. È costituito da strati di carta Kraft impregnati con resine fenoliche e da uno strato superficiale decorativo impregnato con resine termoindurenti. Questi strati sono pressati a 9 Mp e a una temperatura di 150 gradi centigradi.

Self-supporting material suitable for outdoor exposure. It consists of layers of kraft paper impregnated with phenolic resins and of a decorative surface layer impregnated with thermosetting resins. These layers are pressed at 9 Mp and at a temperature of 150 degrees centigrade.

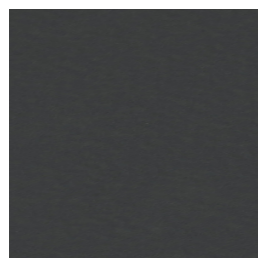

22 GRIGIO
GREY

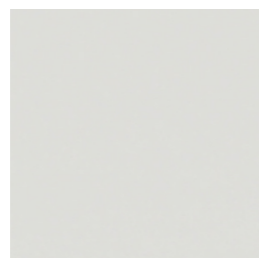

23 BIANCO
WHITE



24 NERO
BLACK

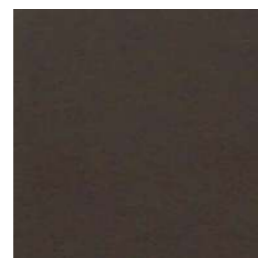

41 MARRONE
BROWN



49 LEGNO SBIANCATO
BLEACHED WOOD



54 MARRONE VINTAGE
VINTAGE BROWN



71 TORTORA
TAUPE



73 CEMENTO
CEMENT

LEGNI—WOODS

BAMBÙ - Il bambù è una pianta che cresce rapidamente e che viene raccolta senza causare deforestazione. Dopo la raccolta, lo strato più esterno viene rimosso e le lamelle di bambù vengono modificate con uno speciale processo di termotrattamento a 200°C. Tale lavorazione aumenta la stabilità del materiale, ne assicura la protezione contro funghi e ne garantisce la più alta classe di durabilità possibile. Dopo il processo di compressione al calore, le fibre di bambù sono più forti e più dure di qualsiasi specie di legno esistente. Con questo particolare processo si ottiene una tavola massiccia ad alta densità resistente agli agenti atmosferici.

BAMBOO - Bamboo is a rapidly growing plant which is collected without causing deforestation. After harvesting, the outermost layer is removed and the bamboo strips are modified using a special thermo-treatment process at 200°C, which increases its stability, ensures protection against fungi and guarantees the highest durability class. After the heat compression process the bamboo fibres become stronger and harder than any existing type of wood. With this specific process you can have a high density hardwood material which is resistant to all weather conditions.

TEAK - Tradizionale legno impiegato nell'arredo da esterni dal fascino esotico intramontabile, il teak è un legno duro ad alto contenuto di olio adatto all'uso esterno senza necessità di trattamento di verniciatura. Se non riceve alcun trattamento protettivo, la superficie prenderà una patina grigio argento, naturale protezione della parte interna del legno, considerata un elemento essenziale del fascino del teak. Il teak utilizzato per i prodotti EMU è certificato FSC®.

TEAK - Traditional wood used for outdoor furniture with an exotic and timeless appeal. Teak is a hard wood with a high oil content suitable for outdoor use, without the need of painting. If it does not receive any protective treatment, the surface will turn into a silvery-grey finish, the natural protection of the internal part of the wood, considered an essential part of teak's charm. The teak used for EMU products is FSC® certified.

USO E MANUTENZIONE - Trattandosi di un materiale naturale, si potrebbero osservare variazioni di colore tra un prodotto e l'altro o tra i componenti di uno stesso prodotto. In caso di bruschi cambiamenti di temperatura e in base al tasso di umidità, inoltre, potrebbero verificarsi anche delle crepe. Se non sottoposto ad alcun trattamento di manutenzione tramite l'applicazione periodica di comuni e specifici protettivi a base olio, la superficie prenderà una patina grigio argento che può essere eliminata anche con una leggera carteggiatura superficiale e successiva lucidatura con panno di iuta. Piccole macchie superficiali dovute a olio o altri prodotti alimentari devono essere rimosse tempestivamente, prima che il legno possa assorbirle in profondità, carteggiando la superficie interessata e lucidando con un panno di iuta. Piccole macchie superficiali dovute a olio, caffè, spremute, bevande e altri prodotti alimentari devono essere rimosse tempestivamente con acqua e un panno morbido, prima che il legno possa assorbirle in profondità. Quando il legno si bagna per la prima volta è normale che la superficie diventi un poco ruvida e, una volta asciutta, la levigatura iniziale può essere ripristinata con una leggera carteggiatura superficiale e successiva lucidatura con panno di iuta. Il teak è un materiale naturale che assorbe l'acqua ed è ricco di olii. Con il passare del tempo, questi olii, per un processo naturale, risalgono in superficie e possono macchiare eventuali cuscini che sono stati utilizzati. Le macchie sui cuscini possono essere rimosse utilizzando acqua e sapone.

USE AND MAINTENANCE - As it is a natural material, it could have different nuances from one product to another or between components of the same product. In case of sudden changes in temperature and humidity, moreover, cracks may also occur. If it does not receive any maintenance treatment with the periodic application of common and specific oil-based protective products, the surface will turn into a silvery-grey finish that can be removed with a light sanding surface and subsequent polishing with an hessian cloth. Small stains caused by oil or other food products must be removed immediately, before the wood absorbs them, by sanding the concerned area and by polishing it with an hessian cloth. Stains from coffee, juices, natural drinks, without food additives, can be promptly removed with water and a soft cloth. When the wood gets wet for the first time, it is normal for the surface to become slightly rough when it dries; the initial polished-effect can be restored with light sanding surface and subsequent polishing with an hessian cloth. Teak is a natural material that absorbs water and is rich in oils. Over time, these oils, by a natural process can rise to the surface and stain the cushions that have been used. Stains on the cushions can be removed using soap and water.



44 BAMBÙ
BAMBOO



82 TEAK

COVER



30 GRIGIO SCURO
DARK GREY

WPC

Il WPC è un materiale composito costituito da fibre di legno e HDPE. I semilavorati sono ottenuti tramite estrusione del composito. È un materiale resistente ai raggi UV, agli agenti atmosferici e all'umidità. Il WPC non si scheggia e non viene danneggiato da batteri o insetti. Si tratta di un materiale dalla facile manutenzione. Non deve essere protetto da verniciature.

WPC is a composite material made from wood fibers and HDPE. Semi-finished products are obtained by extruding the composite. This material is resistant to UV rays, atmospheric agents and humidity, WPC does not chip and is not damaged by bacteria or insects. It is a material that requires little maintenance. It does not need to be painted for protection.

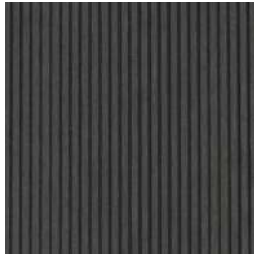

34 ANTRACITE
CHARCOAL

TESSUTI COPERTURE — SHADINGS FABRICS

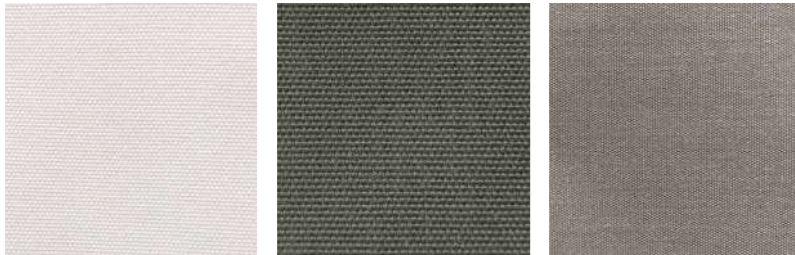

01 BIANCO
WHITE

24 GRIGIO SCURO
DARK GREY

80 BEIGE

TESSUTI BASIC — BASIC FABRICS

Tessuto acrilico: si intende una fibra il cui elemento di base è una catena di polimeri composta all'85% da acrilonitrile. La fibra acrilica unisce alle qualità estetiche di un tessuto lussuoso, dalla corposità e dal touch assimilabili a quelli della lana, le qualità funzionali di resistenza agli agenti atmosferici: resiste ai raggi UV, non si macchia e non si deteriora grazie alla velocità di asciugatura.

Acrylic fabric: a fibre whose base element is a polymer chain consisting of 85% acrylonitrile. Acrylic fibre combines the aesthetic qualities of a luxurious fabric with the texture and feel of wool with the functional qualities of resistance to the elements: UV resistant, it does not stain and does not rot upon contact with water as it is fast-drying.

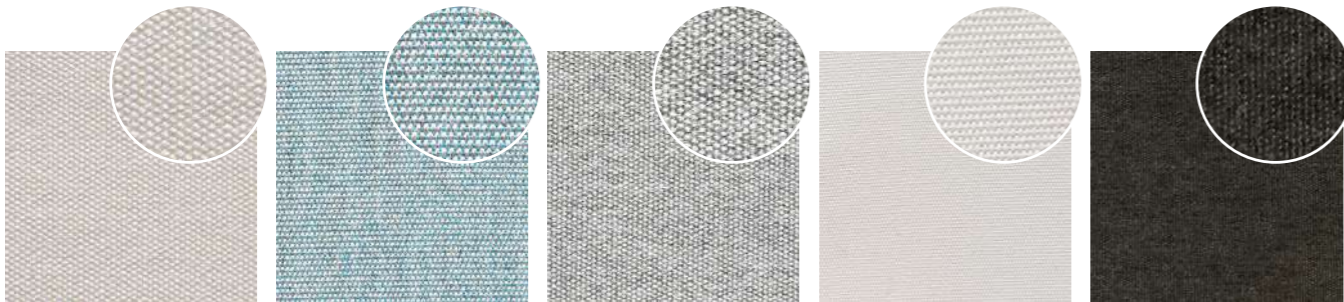

700/4 ECRU

700/10 AZZURRO
LIGHT BLUE

700/13 GRIGIO CHIARO
LIGHT GREY

700/32 BIANCO
WHITE

700/34 GRIGIO SCURO
DARK GREY

TESSUTI EXCLUSIVE — EXCLUSIVE FABRICS

Per informazioni circa la composizione dei tessuti compresi in tale fascia e la specifica manutenzione si prega di far riferimento al sito web www.emu.it o di rivolgersi a info@emu.it oppure all'ufficio commerciale di competenza.

For information regarding the composition of fabrics in this range and their specific maintenance, please refer to the website www.emu.it, write to info@emu.it or contact the respective sales office.

CAT. E

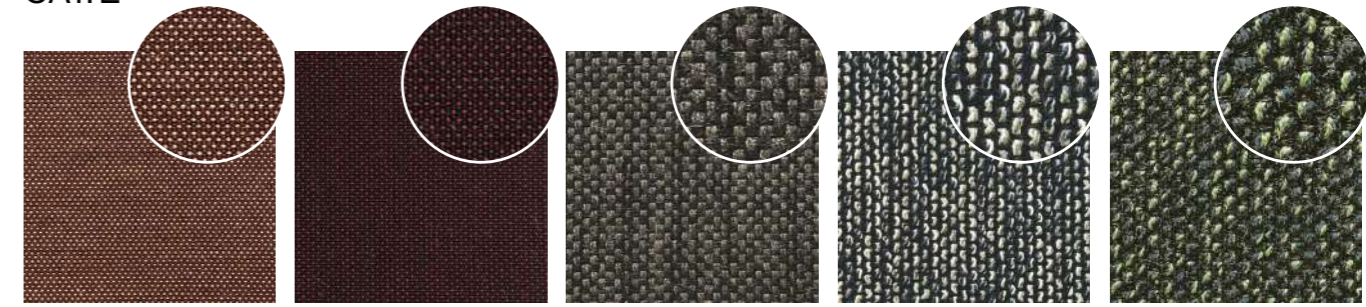

600/31 MATTONE
BRICK RED

600/32 MERLOT

600/33 CLASSICO
CLASSIC

600/34 DENIM

600/35 LAGUNA
LAGOON

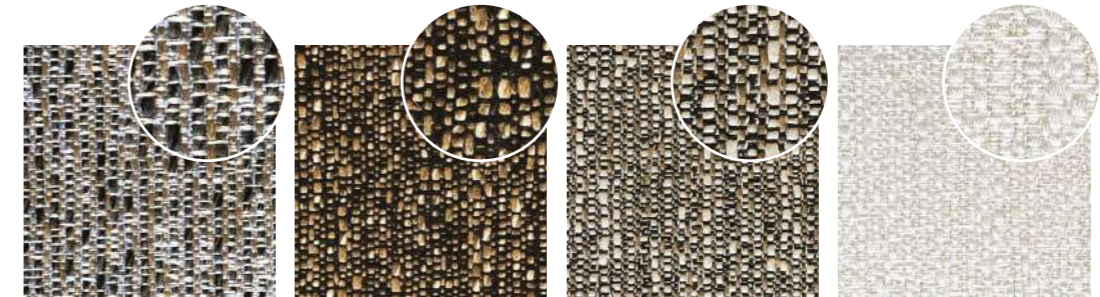

600/36 JOLLY

600/37 CORTECCIA
BARK

600/38 MUSLI

600/39 CIGNO
SWAN

CAT. D

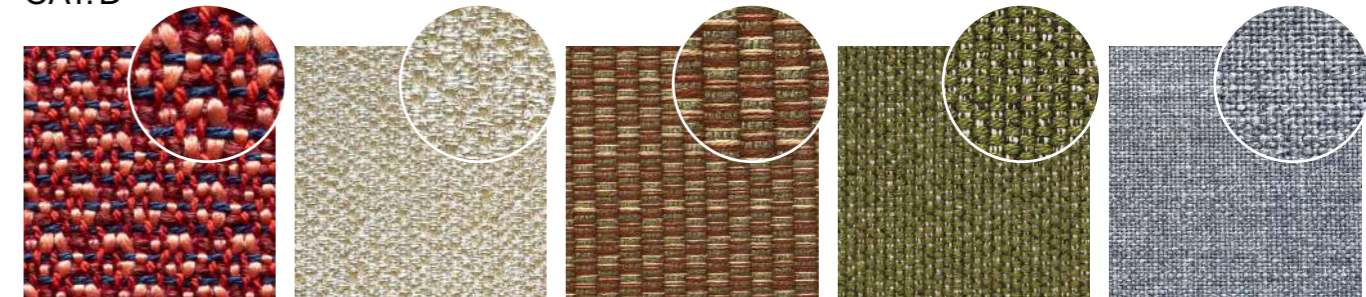

600/27 LAMPONE
RASPBERRY

600/40 ORO
GOLD

600/41 BRONZO
BRONZE

600/42 VERDE
GREEN

600/43 FRESCO
FRESH

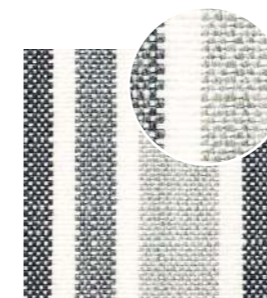

600/44 MARITTIMO
MARINE



600/45 STELOVERDE
GREEN STEM



600/46 STELO TORTORA
TAUPE STEM

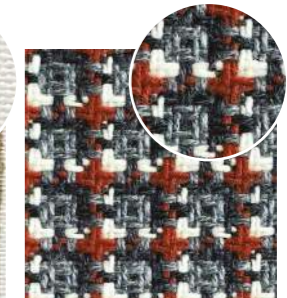

600/48 KASIMIRO ROSSO-BLU
RED-BLUE KASIMIRO



600/49 KASIMIRO AZZURRO
LIGHT BLUE KASIMIRO

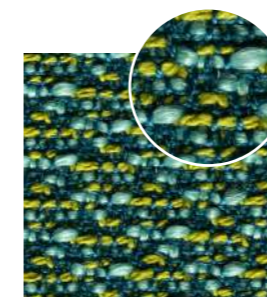

900/16 ASSENZIO
GREEN FAIRY

TESSUTI EXCLUSIVE—EXCLUSIVE FABRICS

CAT. C



CAT. B

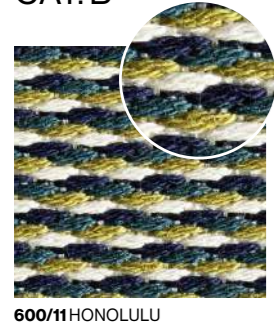

TESSUTI CUSCINI CONTRACT* CONTRACT CUSHIONS FABRICS*

Per informazioni circa la composizione dei tessuti compresi in tale fascia e la specifica manutenzione si prega di far riferimento al sito web www.emu.it o di rivolgersi a info@emu.it oppure all'ufficio commerciale di competenza.

*Tessuti IDROREPELLENTI

For information regarding the composition of fabrics in this range and their specific maintenance, please refer to the website www.emu.it, write to info@emu.it or contact the respective sales office.

*WATER-REPELLENT fabrics



ECO-CUOIO—ECO-LEATHER

L'eco-cuoio è realizzato con microfibrati di Nylon compattata in bagno di poliuretano. Successivamente viene spalmata con poliuretano in tinta.

The eco-leather is made of compacted Nylon micro-fibre in polyurethane bath. It is then coated with polyurethane of the same color.



TESSUTI STANDARD—STANDARD FABRICS

Per informazioni circa la composizione dei tessuti compresi in tale fascia e la specifica manutenzione si prega di far riferimento al sito web www.emu.it o di rivolgersi a info@emu.it oppure all'ufficio commerciale di competenza.

For information regarding the composition of fabrics in this range and their specific maintenance, please refer to the website www.emu.it, write to info@emu.it or contact the respective sales office.

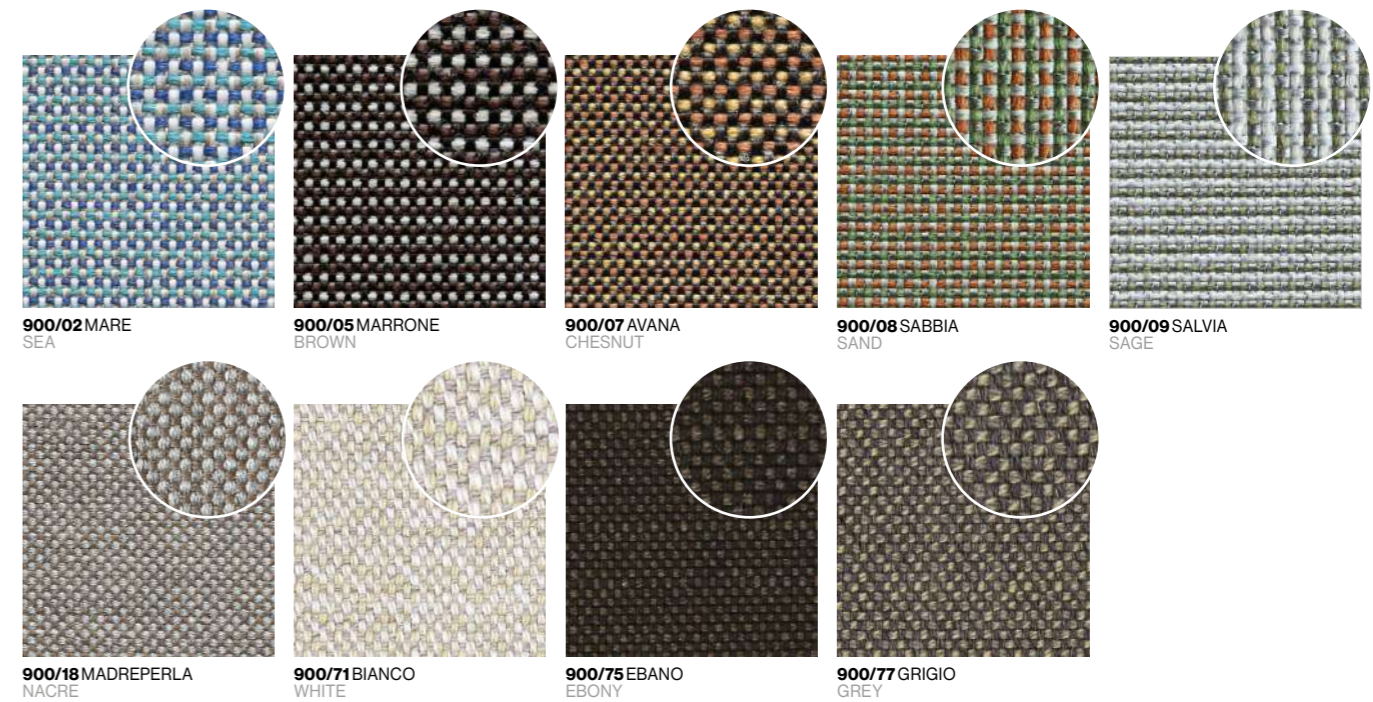

TESSUTI STAMPATI—PRINTED FABRICS



TESSUTI TAPPETI—RUGS FABRICS



concept, progetto grafico,
coordinamento / concept,
graphic desing, supervision:
Studiopiù International

foto / photos:
Studiopiù International
Ettore Panichi
Paolo Veclani
Luigi Benedetti

pag. 15 - Kombuis Restaurant, South Africa - project: Steyn Studio - ph: Adam Letch
pag. 188 - Trullo Ermes & Atena, Italy - project: Rosaria Cocchia - ph: Casedifiaba
pag. 222 - The Orange Cube, France - project: Jakob+MacFarlane - ph: Nicolas Borel
pag. 223 - Bio's Kitchen, Italy - project: Studio Archinow! - ph: Giovanni De Sandre
pag. 223 - Hotel Me Sitges, Spain - project: Lagranja Design - ph: Joan Guillamat
pag. 273 - Sauna Löyly, Finland - project: Avanto Architects - ph: Mikko Ryhänen
pag. 309 - Harrison Urby, USA - project: Concrete - ph: Ewout Huibers

stampa / printing:
Graphic Masters

I prodotti illustrati sono soggetti ad una costante verifica dei particolari funzionali ed a una continua ricerca tecnologica sui trattamenti di finitura.
I prodotti rappresentati nella presente pubblicazione, nonché le descrizioni e le caratteristiche tecniche riportate, sono indicativi e possono essere soggetti a modifiche da parte di EMU Group S.p.A.

The products illustrated are subject to constant revisions in terms of their functional details and continuous research goes into the finishing treatments applied.
The products presented in this publication, as well as the descriptions and the specifications given are illustrative and are subject to change by EMU Group S.p.A.

Documento non contrattuale
Non-contractual document

EMU Group S.p.A.
MARSCIANO, PERUGIA, ITALIA / SETTEMBRE 2024
MARSCIANO, PERUGIA, ITALY / SEPTEMBER 2024



Organizzazione con sistema di gestione della Qualità Certificato UNI EN ISO 9001:2015 da IMQ



Il marchio della gestione forestale responsabile

Richiedi i prodotti certificati FSC®
Look for our FSC® certified products



emu.it

