



Utilidades e Móveis
Utilities and Furniture
Utilidades y Muebles

20
24

TRAMONTINA





UTILIDADES E MÓVEIS

Tramontina Madeiras tem a satisfação de apresentar seus produtos manufaturados em madeira maciça de pinus e também em outros materiais.

A utilização de processos tecnologicamente avançados – em uma fábrica moderna e bem equipada – aliada à experiência técnica e humana da equipe de profissionais que a compõem, garantem a regularidade e a qualidade dos produtos.

UTILITIES AND FURNITURE

Tramontina Madeiras is pleased to present their products manufactured using solid pinus wood and in other materials.

Using modern technologies – in a modern and well equipped factory – together with the technical and human experience of their professional staff, guarantees the exactness and quality of the products.

UTILIDADES Y MUEBLES

Tramontina Madeiras tiene la satisfacción de presentar sus productos en madera maciza de pinos y también en otros materiales.

La utilización de procesos tecnológicamente avanzados – e una fábrica moderna y bien equipada – unida a la experiencia técnica y humana del equipo de profesionales.

A EMPRESA

TRAMONTINA, O PRAZER DE FAZER BONITO.

Mais do que números, o que define a **Tramontina** é o esforço permanente em tornar a vida das pessoas cada vez melhor. A pequena ferraria fundada por Valentin e Elisa Tramontina em 1911, no sul do Brasil, deu origem a um grupo que hoje conta com 9 unidades fabris e mantém a vocação centenária de encantar com gestos simples.

O segredo para manter a essência está em acreditar nas pessoas. A Tramontina valoriza cada um dos mais de 9 mil funcionários para que entreguem ao mercado produtos funcionais e com estilo, que inspiram o dia a dia e estimulam experiências para gerar valor e satisfação a clientes, consumidores e comunidades.

Tudo isso é traduzido nos mais de 18 mil itens que carregam valores de uma marca única. Utensílios e equipamentos para cozinha, eletros, ferramentas para agricultura, jardinagem, manutenção industrial e automotiva, construção civil, materiais elétricos, móveis de madeira ou de plástico, além da ampla linha de equipamentos dirigíveis são fabricados para o mercado nacional e exportados para mais de 120 países.

É no fazer bonito que a Tramontina e as pessoas se encontram. Atuando de forma global, a marca tem o suporte necessário para entregar soluções capazes de atender as necessidades de seu tempo, aliando produtividade e superação de metas ao desenvolvimento sustentável através do programa de gestão ambiental. Muito prazer, Tramontina!

THE COMPANY

TRAMONTINA, BEAUTIFULLY WELL DONE.

More than just numbers, what truly defines Tramontina is the constant effort to make people's lives better. The small iron mill founded by Valentin and Elisa Tramontina in 1911 in southern Brazil was the beginning of a group that now encompasses 9 manufacturing units and has kept the century-old tradition of delighting people with simple gestures.

The secret for maintaining this essence is believing in people. Tramontina values each one of its over 9,000 employees so they can deliver functional, stylish products to the market, bringing inspiration to people's daily living and creating experiences to generate value and satisfy clients, consumers and communities.

All this is apparent in the more than 18,000 items that carry the values of a unique brand. Kitchen utensils and equipment, appliances, tools for agriculture, gardening, industrial and automotive maintenance, construction, electrical hardware, wood and plastic furniture, and a wide range of ride-on equipment is manufactured for the domestic market and exported to over 120 countries.

It is by doing beautiful things well that Tramontina and people are brought together. A global player, the company finds the necessary support to deliver solutions that can meet contemporary demands, combining productivity and going over and beyond targets for sustainable development through the environmental management program.

Pleased to meet you, Tramontina!

LA EMPRESA

TRAMONTINA, EL PLACER DE HACER BIEN LAS COSAS.

Más que números, lo que define a Tramontina es el esfuerzo permanente para mejorar cada vez más la vida de la gente. La pequeña herrería fundada por Valentin y Elisa Tramontina en 1911, en el sur de Brasil, originó un grupo que hoy cuenta con 9 unidades fabriles y mantiene la vocación centenaria de encantar con gestos sencillos.

El secreto para mantener la esencia es creer en las personas. Tramontina valora a cada uno de los más de 9 mil empleados para que le entreguen al mercado productos funcionales y con estilo, que inspiran el día a día y estimulan experiencias para generar valor y satisfacción a clientes, consumidores y comunidades.

Todo eso se traduce en los más de 18 mil artículos que llevan los valores de una marca única. Utensilios y equipos de cocina, electrodomésticos, herramientas para agricultura, jardinería, mantenimiento industrial y automovilístico, construcción civil, materiales eléctricos, muebles de madera o de plástico, además de la amplia línea de equipos dirigibles, que se fabrican para el mercado nacional y de exportación para más de 120 países.

Es en el hacer bien las cosas que se encuentran Tramontina y las personas. Actuando de forma global, la marca tiene el soporte necesario para entregar soluciones capaces de atender las necesidades de su tiempo, aliando productividad y superación de metas de desarrollo sustentable por medio del programa de gestión ambiental.

¡Encantada, Tramontina!



Unidade Fabril MADEIRAS | MADEIRAS Industrial Unit | Unidad Fabril MADEIRAS

TRAMONTINA MADEIRAS

Tramontina Madeiras, fundada em 1990, está localizada em Encruzilhada do Sul, RS.

Hoje, com aproximadamente 32.900 m² de área construída, esta unidade fabril conta com cerca de 230 funcionários que se ocupam de um mix de produtos em madeira, destinados à organização e à decoração da casa: mesas, bancos, banquetas, prateleiras, estantes e painéis, além de mesas de passar, bandejas e componentes com qualidade e excelente acabamento.

O design prático, funcional e colorido é um importante diferencial dos produtos, que vão colaborar na organização da casa para o consumidor fazer bonito no seu dia a dia.

TRAMONTINA MADEIRAS

Tramontina Madeiras was founded in 1990 and is located in Encruzilhada do Sul, in the state of Rio Grande do Sul.

It now has an industrial area of over 32.900 m² and 230 employees who manufacture a wide range of wood products for decoration as well as domestic utensils such as tables, benches, stools, shelves, shelving units, panels, drying racks, trays, and other high-quality components which all have an excellent finish.

The practical, functional, and colorful design is an important distinguishing feature of the products that will help customers organize their homes and do things beautifully well every day.

TRAMONTINA MADEIRAS

Tramontina Madeiras, fundada en 1990, está ubicada en Encruzilhada do Sul, Rio Grande do Sul.

Esta unidad fabril, que hoy cuenta con 32.900 m² de área construída, tiene 230 empleados que se ocupan de un mix de productos de madera, destinados a la organización y decoración de la casa: mesas, bancos, banquetas, estantes, estanterías y paneles, además de tablas de planchar, bandejas y componentes de excelente calidad y terminación.

El diseño práctico, funcional y colorido es un diferencial importante de los productos que colaboran en la organización de la casa para que el consumidor se luzca en su día a día.

Conheça os cenários para uma vida prática e organizada.

Check out the scenarios for a practical, organized life. Conoce los escenarios de una vida práctica y organizada.

[1]

11 DOBRÁVEIS
FOLDING | PLEGABLE

13 BAÚ
CHEST | BAÚL

15 BANDEJAS
TRAYS | BANDEJAS

[2]

19 BANQUETAS NATURALLE
STOOLS NATURALLE
TABURETES NATURALLE

23 CABIDES
HANGERS | PERCHEROS

25 PRATELEIRAS
SHELVES | ESTANTE

31 PAINÉIS FLOREIRA
WALL PLANTER | PANEL FLORERA

33 CASCAS DE PINUS
PINE BARK | CORTEZA DE PINO

37 SUPORTE PARA VASOS
SUPPORT FOR VASES | SOPORTE PARA MACETAS

38 ESTANTE MODULARE
MODULARE SHELVING
ESTANTERIA MODULARE

44 PAINÉIS
PANELS | PANELES

[3]

46 SUPORTES
BRACKETS | SOPORTES

51 MESAS DE PASSAR
IRONING BOARDS | MESAS DE PLANCHAR

51 CESTOS
BASKETS | CESTOS

54 ORGANIZADORES DE PAREDE
WALL ORGANIZERS
ORGANIZADORES DE PARED

[1] organizando o dia a dia

organizing your daily living | organizando el día a día



[2] decorando a casa

decorating your home | decorando la casa



[3] otimizando a área de serviço

optimizing your utility room | optimizando el área de servicio



ORGANIZANDO O DIA A DIA

organizing your daily living | organizando el día a día







CONJUNTO DOBRÁVEL

Para organizar reuniões
com amigos e familiares.

folding set

For get-togethers
with family and friends.

juego plegable

Para organizar reuniones
con amigos y familiares.



conjunto dobrável naturalle rústico

Set Table and Benches Naturalle
Conjunto de Mesa y Bancos Naturalle

• madeira maciça	• solid wood mader maciza
• pés dobráveis	• folding legs patas plegables

REF.	mm	COR COLOR COLOR
------	----	----------------------

91756/101	C 1988 x P 1400 x A 746	garapa
-----------	-------------------------	--------

01 MESA +
02 BANCOS



banco dobrável naturalle rústico

Folding Bench Naturalle
Banco Plegable Naturalle

• madeira maciça	• solid wood mader maciza
• pés dobráveis	• folding legs patas plegables
• suporta até 200kg	• supports up to 200 kg soporta hasta 200kg

REF.	mm	COR COLOR COLOR
------	----	----------------------

91756/023	C 1988 x L 300 x A 485	garapa
-----------	------------------------	--------

SUPOSTA ATÉ
200kg



mesa dobrável naturalle rústico

Folding Table Naturalle
Mesa Plegable Naturalle

• madeira maciça	• solid wood mader maciza
• pés dobráveis	• folding legs patas plegables

REF.	mm	COR COLOR COLOR
------	----	----------------------

91756/028	C 1988 x L 800 x A 746	garapa
-----------	------------------------	--------





conjunto mesa e bancos naturalle

Set Table and Benches Naturalle
Conjunto de Mesa y Bancos Naturalle

• pinus maciço	• solid pinus wood pino macizo
----------------	----------------------------------

REF.	mm	COR COLOR COLOR
------	----	----------------------

91750/103	L 1300 x P 1372 x A 800	natural
-----------	-------------------------	---------



SUPORTA ATÉ
200kg

01 MESA +
02 BANCOS



conjunto mesa e bancos naturalle

Set Table and Benches Naturalle
Conjunto de Mesa y Bancos Naturalle

• pinus maciço	• solid pinus wood pino macizo
• pés dobráveis	• folding legs patas plegables

REF.	mm	COR COLOR COLOR
------	----	----------------------

91750/100	L 2000 x P 1372 x A 800	natural
-----------	-------------------------	---------



SUPORTA ATÉ
200kg

01 MESA +
02 BANCOS

mesa naturalle dobrável naturalle

Folding Table Naturalle
Mesa Plegable Naturalle

• pinus maciço	• solid pinus wood pino macizo
• pés dobráveis	• folding legs patas plegables

REF.	mm	COR COLOR COLOR
91750/018	L 1300 x P 800 x A 800	natural
91750/028	L 2000 x P 800 x A 800	



banco dobrável naturalle

Folding Bench Naturalle
Banco Plegable Naturalle

• pinus maciço	• solid pinus wood pino macizo
• pés dobráveis	• folding legs patas plegables

REF.	mm	COR COLOR COLOR
91750/013	L 1100 x P 286 x A 480	natural
91750/023	L 2000 x P 286 x A 480	natural



SUPORTA ATÉ
200kg

baú

Chest
Baúl

• pinus maciço	• solid pinus wood pino macizo
• capacidade: 85,5 litros	• capacity: 85,5 liters capacidad: 85,5 litros

REF.	mm	COR COLOR COLOR	
91750/073	L 743 x P 336 x A 420	natural	
91751/073	L 743 x P 336 x A 420	amarela yellow amarilla	
91752/073	L 743 x P 336 x A 420	azul blue azul	
91753/073	L 743 x P 336 x A 420	vermelha red roja	
91754/073	L 743 x P 336 x A 420	branca white blanca	

SUPORTA ATÉ	
Tampa Cover Tapa	100kg
Interior Bau Chest Inside Baul Interno	50kg





BANDEJAS

Acessório indispensável na casa e no trabalho. Apoio fundamental para os melhores momentos do seu dia.

trays

An indispensable accessory at home and at work. Perfect support for the best moments in your day.

bandejas

Accesorio indispensable en casa o en el trabajo. Apoyo fundamental para los mejores momentos de tu día.



bandeja happy day

Happy Day Tray

Bandeja Happy Day

<ul style="list-style-type: none"> • pinus maciço • pés dobráveis sem trava • laterais em polipropileno 	<ul style="list-style-type: none"> • solid pinus wood pino macizo • folding legs without latch • patas plegables sin cerradura • polypropylene sides laterales en polipropileno
--	---

REF.	mm	COR COLOR COLOR
91390/002	L 608 x P 276 x A 200 [medida útil do tampo: 440 x 243]	natural cantoneira coral coral corner esquinero coral
91390/003		natural cantoneira camurça suede corner esquinero gamuza
91390/004		natural cantoneira branca white corner esquinero blanco
91390/008		natural cantoneira preta black corner esquinero negro



SUPORTA ATÉ

4kg



bandeja small

Small Tray

Bandeja Small

• pinus maciço	• solid pinus wood pino macizo
----------------	----------------------------------

REF.	mm	COR COLOR COLOR
91390/108	L 608 x P 276 x A 200 [medida útil do tampo: 443x245mm]	natural cantoneira preta black corner esquinero negro
91394/108		natural cantoneira branca white corner esquinero blanco
91390/119		natural cantoneira grafite graphite corner esquinero grafito



SUPORTA ATÉ

4kg



DECORANDO A CASA

decorating your home | decorando la casa







BANQUETAS

Versáteis, leves e bonitas.
Para todos os momentos e
para combinar com outras
peças da decoração.

stools

Versatile, light and beautiful.
Perfect for any occasion,
matching other decorative items.

taburetes









Versátiles, livianas y bonitas.
Para todos los momentos y para combinar
con otras piezas de decoración.



banqueta naturalle alta

Stool Naturalle
Taburete Naturalle

• pinus maciço	• solid pinus wood pino macizo
----------------	----------------------------------

REF.	mm	COR COLOR COLOR	
91410/072	L 400 P 400 A 708	natural	
91411/072		amarela yellow amarilla	
91412/072		azul blue azul	
91413/072		vermelha red roja	
91414/072		branca white blanca	
91417/072		verniz varnished barniz	
91418/072		preta black negra	
91417/078		preto e verniz black and varnisher negra e barniz	
91417/178		garapa	









SUPORTA ATÉ
140kg



banqueta naturalle baixa

Stool Naturalle
Taburete Naturalle

• pinus maciço	• solid pinus wood pino macizo
----------------	----------------------------------

REF.	mm	COR COLOR COLOR	
91410/047	L 322 P 322 A 453	natural	
91411/047		amarela yellow amarilla	
91412/047		azul blue azul	
91413/047		vermelha red roja	
91414/047		branca white blanca	
91417/047		verniz varnished barniz	
91418/047		preta black negra	
91417/048		preto e verniz black and varnisher negra e barniz	
91417/148		garapa	

SUPORTA ATÉ
140kg

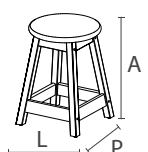







banqueta rústica alta

Rustic Stool
Taburete Rústica

• pinus maciço	• solid pinus wood pino macizo
----------------	----------------------------------

REF.	mm	COR COLOR COLOR	
91411/172	L 400 P 400 A 708	amarela yellow amarilla	
91412/172		azul blue azul	
91413/172		vermelha red roja	
91414/172		branca white blanca	
91418/172		preta black negra	



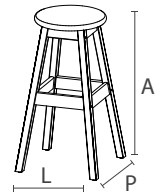

SUPORTA ATÉ
140kg



banqueta rústica baixa

Rustic Stool
Taburete Rústica

• pinus maciço	• solid pinus wood pino macizo
----------------	----------------------------------

REF.	mm	COR COLOR COLOR	
91411/147	L 322 P 322 A 453	amarela yellow amarilla	
91412/147		azul blue azul	
91413/147		vermelha red roja	
91414/147		branca white blanca	
91418/147		preta black negra	

SUPORTA ATÉ
140kg

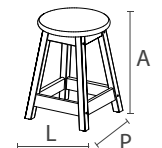

banqueta naturalle vin alta

Stool Naturalle Vin
Taburete Naturalle Vin

• pinus maciço	• solid pinus wood pino macizo
• assento forrado em courvin	• asiento forrado en cuerina stool with synthetic leather lining

REF.	mm	COR COLOR COLOR
91442/072	L 400 P 400 A 708	cinza gray gris
91444/072		branca white blanca
91448/072		preta black negra
91449/072		camurça suede gamuza

SUPORTA ATÉ
140kg



banqueta naturalle vin baixa

Stool Naturalle Vin
Taburete Naturalle Vin

• pinus maciço	• solid pinus wood pino macizo
• assento forrado em courvin	• asiento forrado en cuerina stool with synthetic leather lining

REF.	mm	COR COLOR COLOR
91442/047	L 322 P 322 A 453	cinza gray gris
91444/047		branca white blanca
91448/047		preta black negra
91449/047		camurça suede gamuza

SUPORTA ATÉ
140kg





CABIDES

Acessórios sempre úteis
em qualquer ambiente da casa.
Eles não podem faltar.

hangers

Always useful accessories
in any room in the house.
They cannot be missed.

percheros

Accesorios siempre útiles
en cualquier habitación de la casa.
No se los pueden perder.

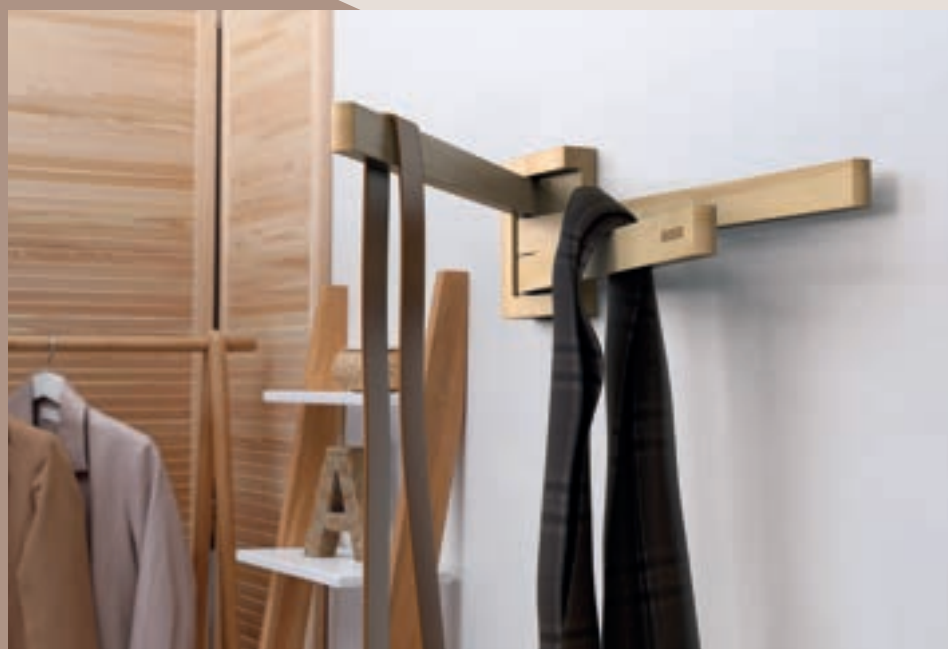

cabide de apoio

Support Hanger
Percha de Apoio

<ul style="list-style-type: none"> • madeira de pinus maciça • Produto montado • Acompanha parafuso e bucha para fixação • Hastes móveis • Não possui trava nas hastes 	<ul style="list-style-type: none"> • solid pinus wood pino macizo • produto montado • assembled product producto armado • screws and bushings are included for wall se incluye tornillo y buje para fijación en la pared • there is no lock on the stems no posee trava en los ejes
---	--

REF.	mm	COR COLOR COLOR
91477/042	C 420 x L 30 x P149	verniz varnished barniz



SUPORTA ATÉ
2kg
POR HASTE





PRATELEIRAS

Soluções para organizar e decorar todos os ambientes da sua casa!

Diversidade em modelos, tamanhos, cores e suportes. Acompanham parafusos e buchas para instalação.



shelves

Solutions for organizing and decorating all the rooms in your home.

Variety of models, sizes, colors and mounting brackets. Screws and wall plugs for mounting included.

estantes

Soluciones para organizar y decorar todos los ambientes de tu casa.

Diversidad de modelos, tamaños, colores y soportes. Vienen con tornillos y tacos de fijación para su instalación.

prateleira elite – suporte invisível

Elite Shelf | Hidden Bracket
Estante Elite | Soporte Invisible

• acompanham parafusos e buchas	• screws and fittings included acompañan tornillos y cojinetes
---------------------------------	---

REF.	mm		COR COLOR COLOR	
91273/065	L 600			
91273/095	900	P 250	A 25	maple
91273/125	1200			
91274/065	600			
91274/095	900	P 250	A 25	branca white blanca
91274/125	1200			
91275/065	600			
91275/095	900	P 250	A 25	amêndoa almond almendra
91275/125	1200			
91276/065	600			
91276/095	900	P 250	A 25	castanho escuro castaño oscuro dark brown
91276/125	1200			
91277/065	600			
91277/095	900	P 250	A 25	noce brianza
91277/125	1200			

SUPOSTA ATÉ
10kg

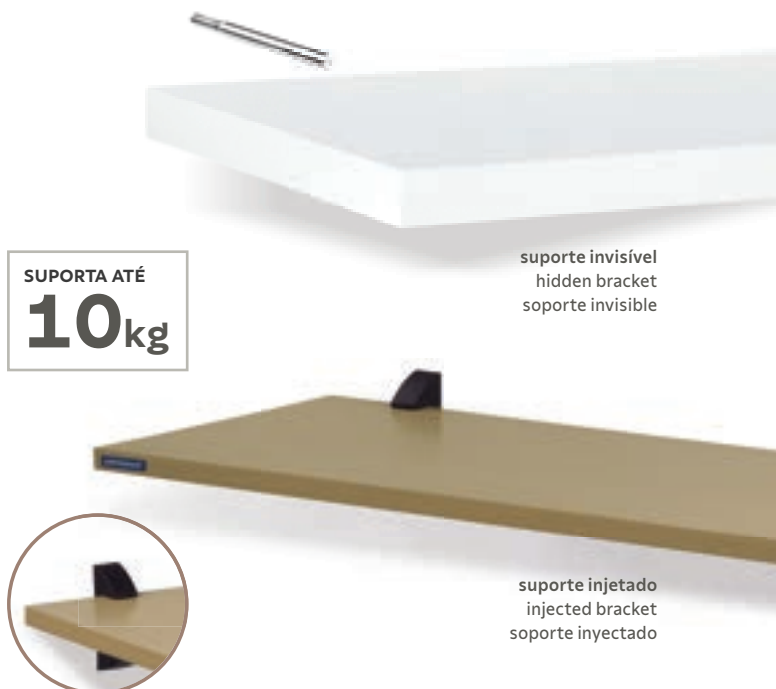

suporte invisível
hidden bracket
soporte invisible

SUPOSTA ATÉ
10kg

suporte injetado
injected bracket
soporte inyectado

prateleira elite – suporte injetado

Elite Straight Shelf | Injected Bracket
Estante Elite | Soporte Inyectado

• acompanham parafusos e buchas	• screws and fittings included acompañan tornillos y cojinetes
---------------------------------	---

	REF.	mm		COR COLOR COLOR	
SUPORTE BRANCO WHITE BRACKET SOPORTE BLANCO	91283/041	L 400			
	91283/061	600	P 250	A 15	maple
	91283/091	900			
	91283/121	1200			
	91284/041	400	P 250	A 15	branca white blanca
	91284/061	600			
	91284/091	900			
	91284/121	1200	P 250	A 15	amêndoa almond almendra
	91285/041	400			
	91285/061	600			
	91285/091	900	P 250	A 15	castanho escuro castaño oscuro dark brown
	91285/121	1200			
91286/041	400	P 250			
91286/061	600				
91286/091	900				
91286/121	1200	P 250	A 15	noce brianza	
91287/041	400				
91287/061	600				
91287/091	900	P 250	A 15	noce brianza	
91287/121	1200				





SUPORTA ATÉ
10kg



SUPORTA ATÉ
10kg

prateleira elite – suporte metálico

Elite Straight Shelf Metallic Bracket
Estante Elite Soporte Metálico

- acompanham parafusos e buchas
- screws and fittings included
- acompanñan tornillos y cojinetes

REF.	mm		COR COLOR COLOR	
91283/047	L 400	P 250	A 15	maple
91283/067	600			
91283/097	900			
91283/127	1200			
91284/047	400	P 250	A 15	branca white blanca
91284/067	600			
91284/097	900			
91284/127	1200			
91285/047	400	P 250	A 15	amêndoa almond almendra
91285/067	600			
91285/097	900			
91285/127	1200			
91286/047	400	P 250	A 15	castanho escuro castaño oscuro dark brown
91286/067	600			
91286/097	900			
91286/127	1200			
91287/047	400	P 250	A 15	noce brianza
91287/067	600			
91287/097	900			
91287/127	1200			

prateleira reta

Straight Shelf Wood Bracket
Estante Recta Soporte Madera





- suporte de pinus maciço
- solid pinus wood bracket
- soporte de madeira maciza
- acompanha parafusos e buchas
- screws and fittings included
- acompanñan tornillos y cojinetes

REF.	mm	COR COLOR COLOR
91240/042	L 400 x P 200 x A 18	natural
91240/062	L 600 x P 200 x A 18	
91240/092	L 900 x P 200 x A 18	
91240/122	L 1200 x P 200 x A 18	mel honey miel
91241/042	L 400 x P 200 x A 18	
91241/062	L 600 x P 200 x A 18	
91241/092	L 900 x P 200 x A 18	
91241/122	L 1200 x P 200 x A 18	branca white blanca
91244/042	L 400 x P 200 x A 18	
91244/062	L 600 x P 200 x A 18	
91244/092	L 900 x P 200 x A 18	
91244/122	L 1200 x P 200 x A 18	castanho escuro castaño oscuro dark brown
91246/042	L 400 x P 200 x A 18	
91246/062	L 600 x P 200 x A 18	
91246/092	L 900 x P 200 x A 18	
91246/122	L 1200 x P 200 x A 18	

prateleira canto suporte madeira

Corner Shelf Wood Bracket
Estante de Rincón Soporte Madera

- suporte de pinus maciço
- acompanham parafusos e buchas
- solid pinus wood bracket
- suporte de madeira maciza
- screws and fittings included
- acompañan tornillos y cojinetes

REF.	mm	COR COLOR COLOR	
91200/002	L 200 x P 200 x A 18	natural	
91200/003	L 300 x P 300 x A 18		
91200/004	L 400 x P 400 x A 18		
91201/002	L 200 x P 200 x A 18	mel honey miel	
91201/003	L 300 x P 300 x A 18		
91201/004	L 400 x P 400 x A 18		
91204/002	L 200 x P 200 x A 18	branca white blanca	
91204/003	L 300 x P 300 x A 18		
91204/004	L 400 x P 400 x A 18		
91206/002	L 200 x P 200 x A 18	castanho escuro castaño oscuro dark brown	
91206/003	L 300 x P 300 x A 18		
91206/004	L 400 x P 400 x A 18		



SUPORTA ATÉ
10kg



prateleira glass

Glass Shelf
Estante Glass

- suporte injetado
- acompanham parafusos e buchas
- plastic bracket | soporte plastico
- screws and fittings included
- acompañan tornillos y cojinetes

	REF.	mm	COR COLOR COLOR
CANTO CORNER RINCÓN	91220/002	L 200 x P 200 x A 08	transparente
	91220/003	L 300 x P 300 x A 08	
	91220/025	L 250 x P 250 x A 08	
RETA STRAIGHT RECTA	91220/410	L 400 x P 100 x A 08	transparente
	91220/415	L 400 x P 150 x A 08	
	91220/420	L 400 x P 200 x A 08	
	91220/510	L 500 x P 100 x A 08	
	91220/515	L 500 x P 150 x A 08	
	91220/520	L 500 x P 200 x A 08	
	91220/610	L 600 x P 100 x A 08	
	91220/615	L 600 x P 150 x A 08	
QUADRA QUADRA QUADRA	91221/002	L 200 x P 200 x A 08	transparente
	91221/003	L 300 x P 300 x A 08	
	91221/025	L 250 x P 250 x A 08	

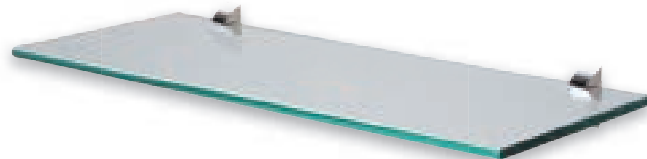

SUPORTA ATÉ
7kg

VIDRO NÃO
TEMPERADO



prateleira econômica

Economic Shelf
Estante Economica

- suporte de pinus maciço
- acompanham parafusos e buchas
- solid pinus wood bracket
- soporte de madera maciza
- screws and fittings included
- acompañan tornillos y cojinetes

REF.	mm	COR COLOR COLOR	
91240/052	L 500 x P 190 x A 18	natural	
91244/052	L 500 x P 190 x A 18	branca white blanca	
91246/052	L 500 x P 190 x A 18	castanho escuro castaño oscuro dark brown	

SUPORTA ATÉ

10kg



prateleira suporte para fornos

Support Shelf for Ovens
Estante para Hornos

- suporte metálico
- acompanham parafusos e buchas
- metalic bracket | soporte metálico
- screws and fittings included
- acompañan tornillos y cojinetes

REF.	mm	COR COLOR COLOR	
91284/645	L 600 x P 450 x A 18	branca white blanca	

SUPORTA ATÉ

25kg



kit frescobol

Frescoball Kit
Kit Frescobol

• pinus maciço	• solid pinus wood pino macizo
• bola de borracha	• rubber ball pelota de goma

REF.	mm	COR COLOR COLOR
91900/071	L 410 x P 220 x A 55,5	natural



BOLA COM
CORES VARIADAS





painel floreira horizontal

Wall Planter
Panel Florera

- pinus maciço
- acompanham parafusos e buchas
- não acompanha acessórios e ferragens para pendurar.
- solid pinus wood | pino macizo
- screws and fittings included acompanñ tornillos y cojinetes
- accessories and hardware for hanging not included | no viene con accesorios ni herrajes para colgar

REF.	mm	COR COLOR COLOR
91150/100	C 1000 x L 560 x P 40	natural



SUPORTA ATÉ

20kg



painel floreira horizontal com prateleiras

Shelf Wall Planter
Panel Florera con Estantes

- pinus maciço
- acompanham parafusos e buchas
- solid pinus wood | pino macizo
- screws and fittings included acompanñ tornillos y cojinetes

REF.	mm	COR COLOR COLOR
91150/110	C 1000 x L 560 x P 230	natural



SUPORTA ATÉ

20kg

POR PRATELEIRA



painel floreira vertical

Vertical Wall Planter
Panel Florera Vertical

- pinus maciço
 - acompanham parafusos e buchas
 - não acompanha acessórios e ferragens para pendurar.
- solid pinus wood | pino macizo
 - screws and fittings included
 - acessórios e ferragens para hanging not included | no viene con accesorios ni herrajes para colgar

REF.	mm	COR COLOR COLOR
91150/101	C 560 x L 1000 x P 40	natural



SUPORTA ATÉ
20kg



painel floreira vertical com prateleiras

Shelf Vertical Wall Planter
Panel Florera Vertical con Estantes

- pinus maciço
 - acompanham parafusos e buchas
- solid pinus wood | pino macizo
 - screws and fittings included
 - acompanham tornillos y cojinetes

REF.	mm	COR COLOR COLOR
91150/111	C 560 x L 1000 x P 230	natural



SUPORTA ATÉ
20kg
POR PRATELEIRA





CASCAS DE PINUS

Quem ama cuidar do jardim, sabe da importância de oferecer o que há de melhor às suas plantas!

- Cria uma camada protetora na terra.
- Mantém o vaso úmido por mais tempo.
- Mantém o solo fértil por mais tempo.
- Reduz o aparecimento de ervas daninhas.
- Evita a erosão e compactação do solo.
- Promove uma maior longevidade às plantas.
- É ecologicamente correta e biodegradável.
- Não tem cheiro.

pine bark

Everyone who loves gardening knows the importance of giving their plants the best there is to offer!

- Creates a protective layer on the soil.
- Keeps the plant pot moist longer.
- Keeps the soil fertile longer.
- Reduces the occurrence of weeds.
- Prevents soil erosion and compression.
- Promotes greater plant longevity.
- It is environmentally friendly and biodegradable.
- It has no odor.

cortezas de pinus

Quienes les encanta cuidar el jardín conocen la importancia de darles lo mejor a sus plantas!

- Crea una capa protectora en la tierra.
- Mantiene húmeda la maceta por más tiempo.
- Mantiene el suelo fértil por más tiempo.
- Disminuye la aparición de malezas.
- Evita la erosión y la compactación del suelo.
- Promueve la mayor longevidad de las plantas.
- Es ecológicamente correcta y biodegradable.
- No posee olor.

casca de pinus polida

Polished Pine Bark
Corteza de Pino Pulida

• casca de pinus	• pine bark corteza de pino
• 100% natural	• 100% natural
• pronto para uso	• ready for use lista para usar

REF.	TAMANHO APROXIMADO DA CASCA [cm]	PESO [kg]	VOLUME APROXIMADO [L]
91401/003	mini 1 a 2	0,3	1
91401/001		1	3,5
91401/005		5	20
91401/008		8	33
91402/003	P 2 a 3,5	0,3	1,2
91402/001		1	3,4
91402/005		5	23
91402/008		8	33
91403/003	M 3,5 a 7	0,3	1,5
91403/001		1	4,5
91403/005		5	22
91403/008		8	34,5
91404/001	G 7 a 15	1	5
91404/005		5	34,5
91404/008		8	36



casca de pinus triturada

Crushed Pine Bark
Corteza de Pino Triturada

• casca de pinus triturada	• crushed pine bark corteza de pino triturada
• 100% natural	• 100% natural
• pronto para uso	• ready for use lista para usar

REF.	PESO [kg]	VOLUME APROXIMADO [L]
91400/010	1	5





substrato

Plant Substrate
Sustrato

- | | |
|---|---|
| <ul style="list-style-type: none"> • casca de pinus compostada • 100% natural, pronto para uso • pode ser utilizado em jardins e vasos de plantas • pode ser utilizado para o cultivo de várias culturas de plantas (árvores, hortaliças, grammas e flores) nos mais variados locais, em tubetes, bandejas, vasos e no solo | <ul style="list-style-type: none"> • composted pine bark corteza de pino compostada • 100% natural • ready for use lista para usar • can be used in gardens and in plant pots • It can be used for the cultivation of various plants (trees, vegetables, grasses, and flowers) in various places, in tubes, trays, plant pots and in the soil. puede utilizarse en el cultivo de varias plantas (árboles, hortalizas, césped y flores) en los más diversos lugares, como tubos, bandejas, macetas y en el suelo. |
|---|---|

REF.	PESO [KG]	VOLUME APROXIMADO [L]
91400/012	2	5,5
91400/011	10	30



mix para orquídea

Orchid Mix
Mix para Orquídeas

- | | |
|---|--|
| <ul style="list-style-type: none"> • casca de pinus esterilizada e carvão vegetal • 100% natural • pronto para uso • ideal para orquídeas com raízes mais finas | <ul style="list-style-type: none"> • sterilized pine bark and charcoa • corteza de pino esterilizada y carbón vegetal • 100% natural • ready for use lista para usar • ideal for orchids with thinner roots • ideal para orquídeas con raíces más finas. |
|---|--|

REF.	TAMANHO APROXIMADO DA CASCA [cm]	PESO [KG]	VOLUME APROXIMADO [L]
91400/020	1 a 2	1	4



orquídea premium tipo exportação

Premium Export-type Orchid

Orquídea Premium Tipo Exportación

<ul style="list-style-type: none"> casca de pinus esterilizada e carvão vegetal 100% natural pronto para uso ideal para orquídeas com raízes mais robustas 	<ul style="list-style-type: none"> sterilized pine bark and charcoa corteza de pino esterilizada y carbón vegetal 100% natural ready for use lista para usar ideal for orchids with stronger roots ideal para orquídeas con raíces más robustas
--	---

REF.	TAMANHO APROXIMADO DA CASCA [cm]	PESO [KG]	VOLUME APROXIMADO [L]
91400/021	3 a 4	1	4
91400/025		5	21,5



substrato rosa do deserto

Pink Desert Rose Substrate

Sustrato Rosa del Desierto

<ul style="list-style-type: none"> casca de pinus compostada, casca de pinus triturada fina, carvão vegetal triturado e agrominerais 100% natural ideal para plantio de rosas do deserto 	<ul style="list-style-type: none"> omposted pine bark, finely shredded pine bark, shredded charcoal and organic minerals corteza de pino compostada, corteza de pino triturada fina, carbón vegetal triturado y agrominerales 100% natural ideal for planting desert roses ideal para plantar rosas del desierto
---	---

REF.	PESO [KG]	VOLUME APROXIMADO [L]
91400/030	1	3,2





SUPORTES PARA VASOS

**Além de decorar, são muito práticos para acomodar os vasos, protegendo os móveis da umidade!
Com criatividade, podem ter diferentes usos!**

support for vases

**In addition to decorating, they are very convenient to hold plant pots, protecting the furniture against humidity!
With creativity, they can have different uses!**

soporte para Macetas

**¡Además de decorar, son muy prácticos para acomodar las macetas y proteger a los muebles contra la humedad!
¡Con creatividad, pueden tener diferentes usos!**



suporte para vasos

Support for Vases

Soporte para Macetas

<ul style="list-style-type: none"> • pinus maciço • produto semi montado • acompanha parafuso para montagem • acabamento natural, sem pintura 	<ul style="list-style-type: none"> • solid pinus wood pino macizo • product sold semi-disassembled el producto se vende semi desmontado • hardware kit and assembly instructions enclosed viene con kit de herramientas e instrucciones de armado • natural unpainted wood finish terminación en madera natural, sin pintura
---	--

REF.	mm	COR COLOR COLOR
91620/610	C 594 x L 242 x A 210	natural



SUPORTA ATÉ
22kg



estante modulare

Modulare Shelving
Estanteria Modulare

• pinus maciço • solid pinus wood | pino macizo

REF.	PRATELEIRAS SHELVES ESTANTES	mm	COR COLOR COLOR
91622/016	2	L 622 x P 302 x A 432	natural
91621/002	2	L 900 x P 302 x A 432	
91620/017	3	L 622 x P 302 x A 752	
91621/003	3	L 900 x P 302 x A 752	
91620/019	4	L 622 x P 302 x A 1072	
91621/004	4	L 900 x P 302 x A 1072	
91620/018	5	L 622 x P 302 x A 1392	
91621/005	5	L 900 x P 302 x A 1392	
91620/020	6	L 622 x P 302 x A 1712	
91621/006	6	L 900 x P 302 x A 1712	

SUPOUTA ATÉ

10kg

POR PRATELEIRA

É possível agrupar
outras unidades
de estantes.

It is possible to attach
other shelving units.

Se pueden agrupar otras
unidades de estanterías.

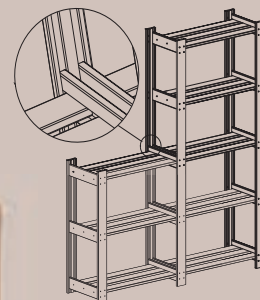
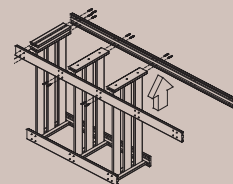
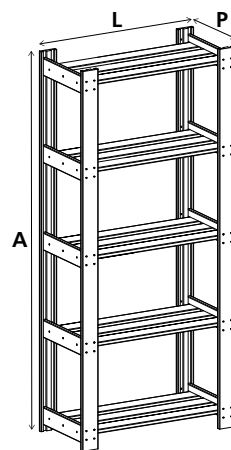



PAINÉIS EM MADEIRA MACIÇA

**Personalize do seu jeito,
explore sua criatividade e
faça você mesmo.**

**Com Painés Tramontina,
você resolve seus problemas
e embeleza o ambiente da sua casa.**

**Painéis em diferentes estilos
de acabamento.**

**Disponíveis em várias dimensões.
Comprimentos de 60 a 200 cm
e larguras de 20 a 80 cm.
Espessura de 1,8 e 2,5 cm.**

solid wood panels

**Personalize them your way, let your
creativity flow and do it yourself.**

**With Tramontina's solid wood panels,
you will find solutions to your problems
and add beauty to your home.**

paneles de madera maciza

**Personalízalos a tu manera, explota
tu creatividad y hazlo tu mismo.**

**Con los paneles Tramontina,
resuelves tus problemas y embellezas
el ambiente de tu casa.**

FAÇA VOCÊ MESMO | DIY | Hazia tu mismo



CARRINHO car | carro

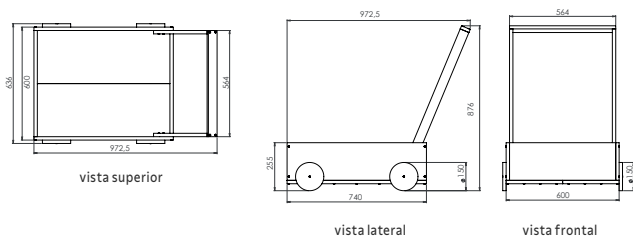

como fazer how to make it | cómo hacer

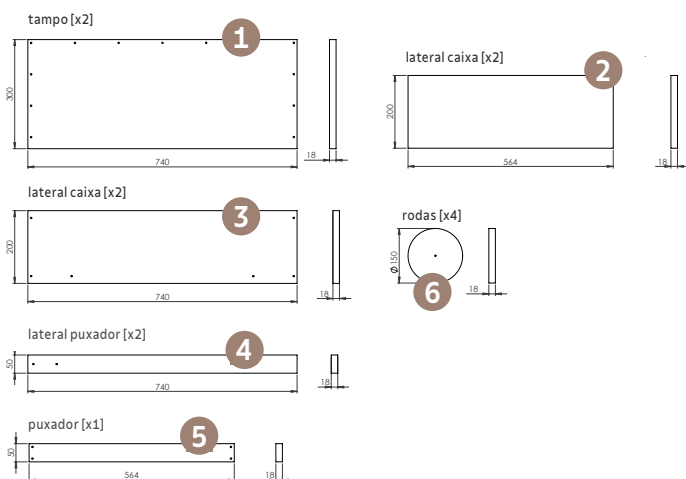

materiais necessários materials | materiales necesarios

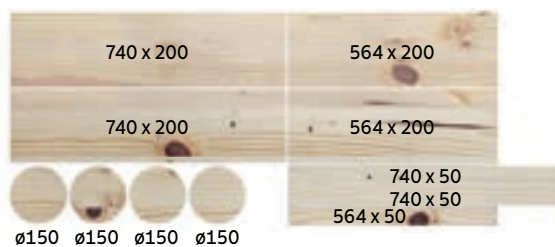

2 painéis | panels | paneles **1500 x 600 x 18 mm**
2 painéis | panels | paneles **1500 x 300 x 18 mm**

para fixar | to asseble | para fijar:
30 parafusos | screws | tornillos 4 x 35 mm
4 1/4" x 2 mm e 4 porcas autotravantes 1/4"



FLOREIRA pinter | florera

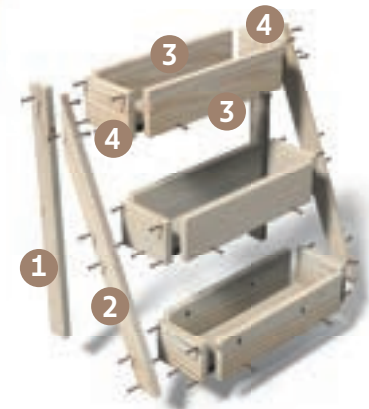
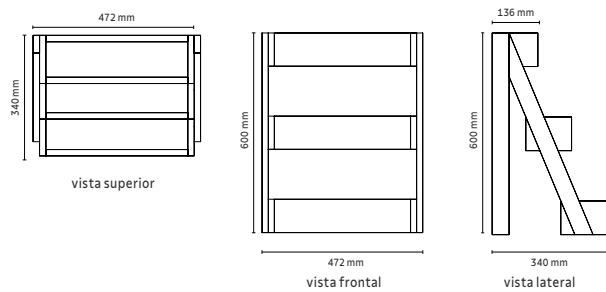

como fazer how to make it | **cómo hacer**

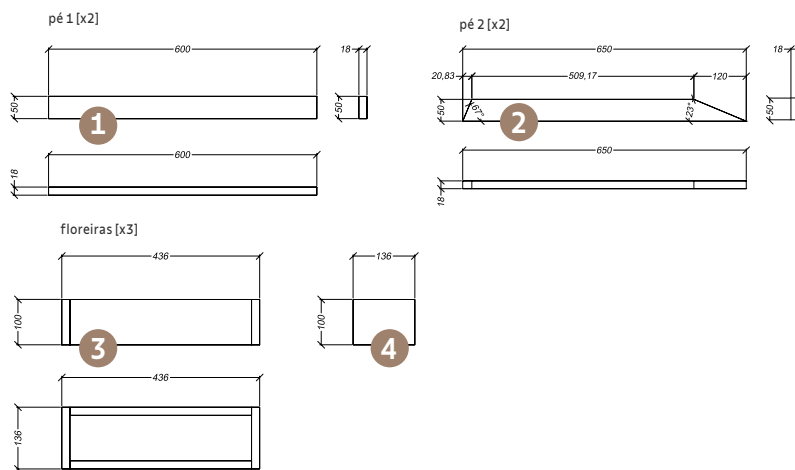

materiais necessários materials | **materiales necesarios**

400 x 100	136 x 100	400 x 100	136 x 100
400 x 100	136 x 100	400 x 100	136 x 100
400 x 100	136 x 100	400 x 100	136 x 100

400 x 100	400 x 100	400 x 100
600 x 50		600 x 50
650 x 50		650 x 50

2 painéis | panels | paneles **1200 x 200 x 18 mm**
2 painéis | panels | paneles **600 x 300 x 18 mm**

para fixar | to asseble | para fijar:
20 parafusos | screws | tornillos **4 x 35 mm**

FAÇA VOCÊ MESMO | DIY | Hazia tu mismo



CAVALETE E ESTANTE trestles and shelf | caballete y estantería

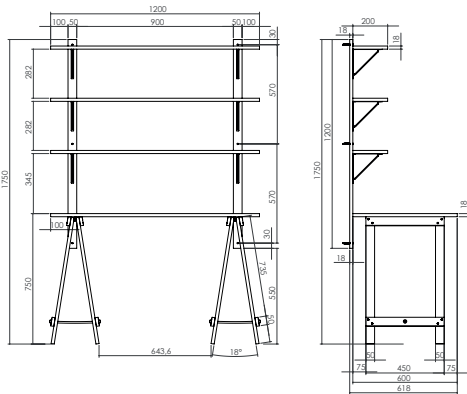

como fazer how to make it | cómo hacer

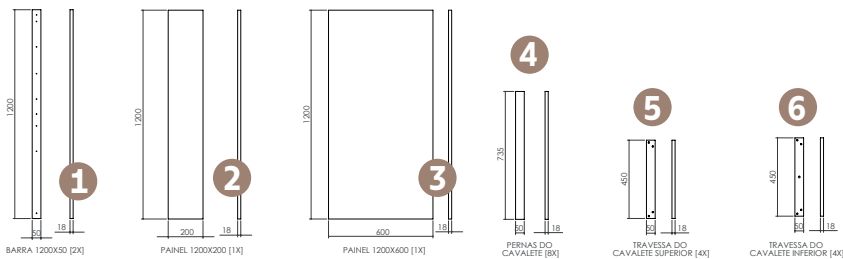

- 3 panels | 91150122 - 1200 x 200 mm [for shelves]
- 1 panel 91150126 - 1200 x 600 mm [for table top]
- 1 panel 91150126 - 1200 x 600 mm [for cutting the other necessary pieces]
- 6 brackets [91804010]
- 6 6mm fittings + 6 5x40 91800023 screws [to assemble the cross pieces to the wall]
- 48 3.5x16 screws [for the hinges and to assemble the shelves to the trestles]
- 32 3.5x30 screws + 4 hinges [for mounting the trestles]
- Rope to limit the opening of the trestle feet

materiais necessários materials | materiales necesarios

- 3 painéis | 91150122 - 1200 x 200 mm [para prateleiras]
- 1 painel 91155128 - 1200 x 800 mm [para tampo da mesa]
- 1 painel 91155128 - 1200 x 800 mm [para o corte das demais peças necessárias]
- 6 suportes [91804010]
- 6 buchas 6mm + 6 parafusos 5x40 91800023 [para fixar as travessas na parede]
- 48 parafusos 3,5x16 (para as dobradiças e para fixar as prateleiras nos suportes)
- 32 parafusos 3,5x30 + 4 dobradiças [para montagem dos cavaletes]
- Corda para limitar a abertura dos pés dos cavaletes

- 3 paneles | 91150122 - 1200 x 200 mm [para estantes]
- 1 panel | 91150126 - 1200 x 600 mm [para mesa]
- 1 panel 91150126 - 1200 x 600 mm [para el corte de las demás partes necesarias]
- 6 soportes [91804010]
- 6 tacos 6 mm + 6 tornillos 5 x 40 91800023 [para fijar los travesaños a la pared]
- 48 tornillos 3,5 x 16 [para las bisagras y para fijar los estantes a los soportes]
- 32 tornillos 3,5 x 30 + 4 bisagras [para armar los caballetes]
- Cuerda para limitar la abertura de las patas de los caballetes



CASINHA PET pet house | casa de mascota

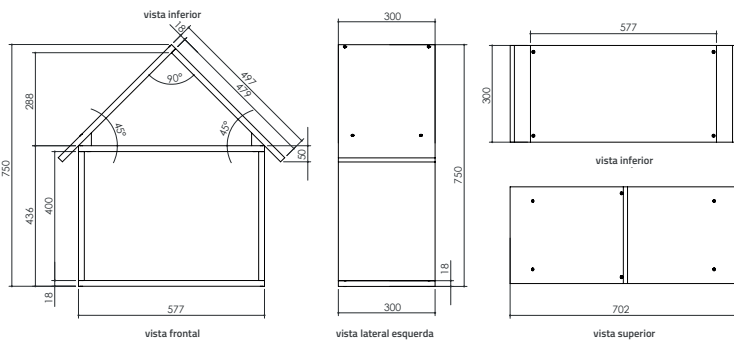

como fazer how to make it | cómo hacer

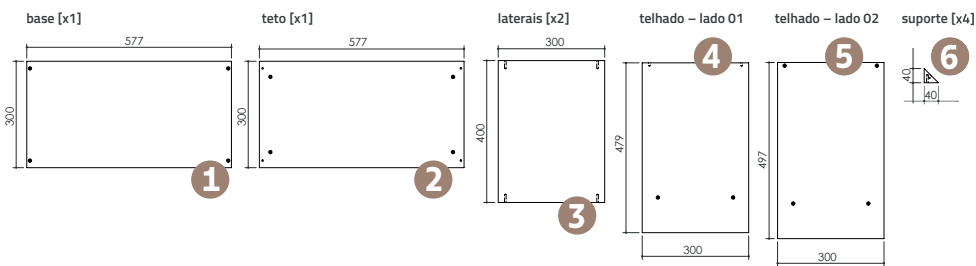

materiais necessários materials | materiales necesarios

2 painéis | panels | paneles **1200 x 300 mm**



1 painéis | panels | paneles **1000 x 300 mm**

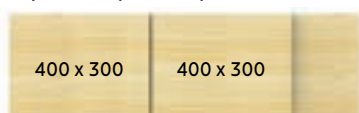

para fixar | to asseble | para fijar:
20 parafusos | screws | tornillos
4 x 35 mm

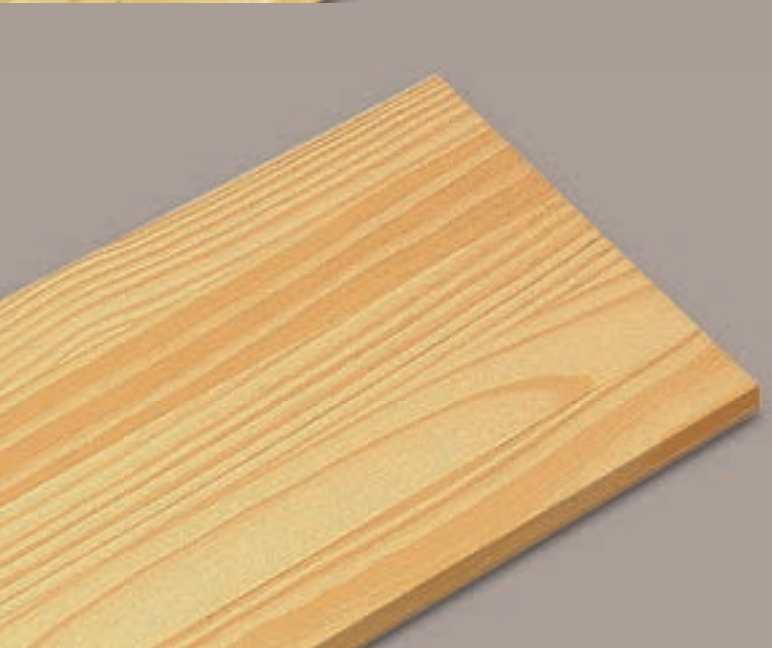

painel natural A/B

Natural A/B Panels
Paneles Natural A/B

REF.	mm		
	C	L	Esp.
91122/062	600	200	18
91122/063		300	
91122/082	800	200	
91122/083		300	
91122/102	1000	200	
91122/103		300	
91122/122	1200	200	
91122/123		300	

REF.	mm		
	C	L	Esp.
91122/152	1500	200	18
91122/153		300	
91122/154		400	
91122/202	2000	200	
91122/203		300	

painel natural C/C

Natural C/C Panels
Paneles Natural C/C

REF.	mm		
	C	L	Esp.
91150/062	600	200	18
91150/063		300	
91150/082	800	200	
91150/083		300	
91150/084	1000	400	
91150/102		200	
91150/103	1000	300	
91150/104		400	
91150/122	1200	200	
91150/123		300	
91150/124		400	
91150/126		600	

REF.	mm		
	C	L	Esp.
91150/152	1500	200	18
91150/153		300	
91150/154		400	
91150/156	2000	600	
91150/202		200	
91150/203	2000	300	
91150/206		600	

tampo para mesa C/C

REF.	mm		
	C	L	Esp.
91155/128	1200	800	25
91155/168	1600	800	25

painel cor mel

Honey Color Panels
Paneles Color Miel

REF.	mm		
	C	L	Esp.
91131/062	600	200	18
91131/063		300	
91131/082	800	200	
91131/083		300	
91131/102	1000	200	
91131/103		300	
91131/122	1200	200	
91131/123		300	

painel cor branca

White Color Panels
Peneles Color Blanca

REF.	mm		
	C	L	Esp.
91133/062	600	200	18
91133/063		300	
91133/082	800	200	
91133/083		300	
91133/102	1000	200	
91133/103		300	
91133/122	1200	200	
91133/123		300	



painel cor castanho escuro

Dark Brown Panels
Paneles Castaño Oscuro

REF.	mm		
	C	L	Esp.
91136/062	600	200	18
91136/063		300	
91136/082	800	200	
91136/083		300	
91136/102	1000	200	
91136/103		300	
91136/122	1200	200	
91136/123		300	

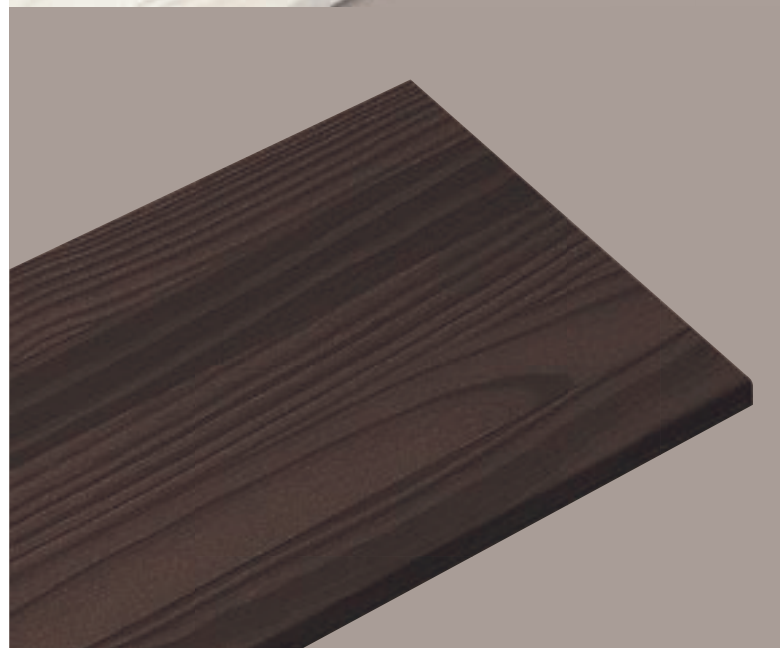

painel branco com borda

White Color Panels Edge
Paneles Color Blanco con Borde

REF.	mm		
	C	L	Esp.
91154/062	600	200	18
91154/063		300	
91154/064		400	
91154/082	800	200	
91154/083		300	
91154/084		400	
91154/102	1000	200	
91154/103		300	
91154/104		400	
91154/122	1200	200	
91154/123		300	
91154/124		400	
91154/126		600	

REF.	mm		
	C	L	Esp.
91154/152	1500	200	18
91154/153		300	
91154/154		400	
91154/156	2000	600	
91154/202		200	
91154/203	2000	300	
91154/206		600	



suporte premium mão francesa

French Hand Premium Bracket
Soporte Premium Mano Francês

• em aço	• in steel en acero
----------	-----------------------

REF.	mm	COR COLOR COLOR
91804/010	A 170 x P 170 x L 14	branca white blanca
91804/011	A 200 x P 200 x L 14	



SUPORTA ATÉ
5kg

suporte premium plus mão francesa

French Hand Premium Plus Bracket
Soporte Premium Plus Mano Francês

• em aço	• in steel en acero
----------	-----------------------

REF.	mm	COR COLOR COLOR
91804/030	A 155 x P 275 x L 19	branca white blanca
91804/040	A 200 x P 350 x L 19	



SUPORTA ATÉ
12,5kg

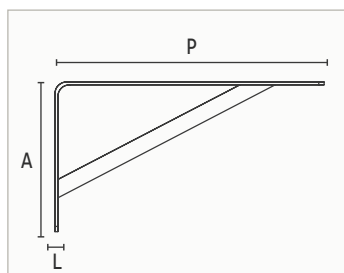

suporte curvo

Curved Bracket
Soporte Curvo

• em aço	• in steel en acero
----------	-----------------------

REF.	mm	COR COLOR COLOR
91804/001	A 100 x P 146 x L 37	branca white blanca
91804/002	A 153 x P 200 x L 37	
91804/003	A 204 x P 249 x L 37	
91804/004	A 254 x P 304 x L 37	
91809/001	A 100 x P 146 x L 37	preta black negra
91809/002	A 153 x P 200 x L 37	
91809/003	A 204 x P 249 x L 37	
91809/004	A 254 x P 304 x L 37	



SUPORTA ATÉ

5kg

suporte metálico

Metallic Bracket
Soporte Metálico

• em aço	• in steel en acero
----------	-----------------------

REF.	mm	COR COLOR COLOR
91289/009	A 200 x P 200 x L 19	preta black negra
91284/009	A 200 x P 200 x L 19	branca white blanca

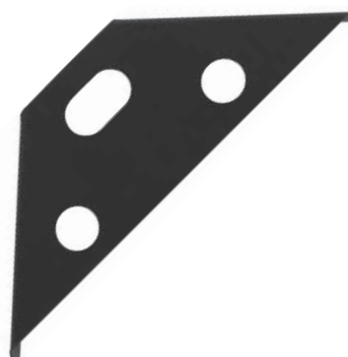

SUPORTA ATÉ

5kg

Kit de Ferragens

Screw Kit with Nylon Bushings
Kit de Tornillos con Casquillos de Nylon

• Parafusos cabeça "Philips"

REF.	mm	COR COLOR COLOR
91800/022	02 parafusos cabeça chata fenda cruzada 4x50mm. 02 buchas de nylon 6mm 03 parafusos cabeça chata fenda cruzada 3,5x16mm	
91800/023	03 parafusos cabeça chata fenda cruzada 4x50mm. 03 buchas de nylon 6mm 03 parafusos cabeça chata fenda cruzada 3,5x16mm	



OTIMIZANDO A ÁREA DE SERVIÇO

optimizing your utility room | optimizando el área de servicio







ÁREA DE SERVIÇO

Leveza e praticidade.
Várias cores e acabamentos
para fazer bonito na área de serviço.

utility room

Lightness and convenience.
Available in various colors and options of finishes
for doing what you do beautifully in your utility room.

área de servicio

Livianas y prácticas.
Varios colores y terminaciones para lucirse
en el área de servicio.



mesa de passar top

Top Ironing Board
Mesa de Planchar Top

<ul style="list-style-type: none"> estrutura em pinus maciço articulações e suporte em metal para ferro de passar 	<ul style="list-style-type: none"> structure in solid pinus wood estructura en pino macizo metallic joints and brackets for iron articulaciones y soportes en metal para plancha
---	--

REF.	mm	COR COLOR COLOR
91751/123	L 1420 x P 395 x A 880	mel honey miel
91750/009		revestimento térmico thermal coating revestimiento térmico



SUPORTE PARA O FERRO

mesa de passar compact classic

Compact Ironing Board
Mesa de Planchar Compact

<ul style="list-style-type: none"> estrutura em pinus maciço suporte em metal para ferro de passar 	<ul style="list-style-type: none"> structure in solid pinus wood estructura en pino macizo metal brackets for iron soportes en metal para planchar
--	--

REF.	mm	COR COLOR COLOR
91750/130	L 1160 x P 340 x A 840	natural compact
91750/140		natural classic
91750/010		revestimento



SUPORTE PARA O FERRO



cesto multiuso

Multi-Purpose Basket
Cesto Multiuso

<ul style="list-style-type: none"> estrutura em madeira maciça tecido 100% algodão capacidade: 42 litros 	<ul style="list-style-type: none"> structure in solid wood estructure en madera maciza 100% cotton 100% algodón capacity: 42 liters capacidad: 42 litros
---	--

REF.	mm	COR COLOR COLOR
91757/250	L 405 x P 398 x A 630	bege beige bege
91757/251		cinza gray gris





mesa de passar - apoio

Tabletop Ironing Board
Mesa de Planchar de Apoio

- | | |
|-------------------------------|---|
| • estrutura em madeira maciça | • structure in solid wood |
| • pé em aço | • estrutura en madera maciza |
| • revestimento térmico | • feet in steel pies en acero |
| | • thermal coating revestimiento térmico |

REF.	mm	COR COLOR COLOR
91750/135	L 852 x P 252 x A 137	cinza gray gris



mesa de passar - dobrável

Foldable Tabletop Ironing Board
Mesa de Planchar Plegable

- | | |
|-------------------------------|---|
| • estrutura em madeira maciça | • structure in solid wood |
| • pé em aço | • estrutura en madera maciza |
| • revestimento térmico | • feet in steel pies en acero |
| | • thermal coating revestimiento térmico |

REF.	mm	COR COLOR COLOR
91750/136	L 852 x P 252 x A 140	cinza gray gris



cesto organizador com corda

Organizer Basket with Fastener Closure
Cesta Organizadora con Cierre

- lona 100% algodão
- corda para fechamento
- 100% cotton canvas | lona 100% algodón
- ropes for closing | cuerdas para cierre

REF.	mm	COR COLOR COLOR
91751/001	L 350 x P 350 x A 430	natural
91751/002		cinza gray gris

CAPACIDADE
41L



cesto organizador com fecho

Organizer Basket with Fastener Closure
Cesta Organizadora con Cierre

- lona 100% algodão
- tampa com fecho
- 100% cotton canvas | lona 100% algodón
- lid with closure | tapa con cierre

REF.	mm	COR COLOR COLOR
91751/006	L 350 x P 350 x A 430	natural
91751/007		cinza gray gris

CAPACIDADE
41L





organizador de parede

Wall Organizer
Organizador de Pared

- suporte de madeira
- lona 100% algodão
- acompanham parafusos e buchas
- wood block | soporte de madera
- 100% cotton canvas | lona 100% algodón
- screws and fittings included
- acompañan tornillos y cojinetes

REF.	mm	COR COLOR COLOR
91751/011	L 300 x P 144 x A 248	natural
91751/012		cinza gray gris



SUPORTA ATÉ

5kg



organizador de parede - 2 bolsos

Wall Organizer - 2 pockets
Organizador de Pared - 2 bolsillos

- corda para pendurar
- lona 100% algodão
- rope for hanging | cuerda para colgar
- 100% cotton canvas | lona 100% algodón

REF.	mm	COR COLOR COLOR
91751/021	A 550 x L 250 x P 80	natural
91751/022		natural-cinza
91751/023		natural-gray natural-gris
91751/024		cinza gray gris
		cinza-ntaural
		gray-natural gris-ntaural



SUPORTA ATÉ

2kg

POR BOLSO

organizador de parede - 3 bolsos

Wall Organizer - 3 pockets

Organizador de Pared - 3 bolsillos

- corda para pendurar
- lona 100% algodão
- rope for hanging | cuerda para colgar
- 100% cotton canvas | lona 100% algodón

REF.	mm	COR COLOR COLOR
91751/031	a 790 x L 250 x P 80	natural
91751/032		natural-cinza natural-gray natural-gris
91751/033		cinza gray gris
91751/034		cinza-ntaural gray-natural gris-ntaural



SUPOSTA ATÉ

2kg

POR BOLSO



expositores

Display Expositores

- | | |
|--|--|
| <ul style="list-style-type: none"> • em pinus maciço pintado • acessórios para colocação dos outros produtos | <ul style="list-style-type: none"> • painted solid pinus wood en pino macizo pintado • accessories for rank of the products accesorios para disponer los productos |
|--|--|

REF.	mm
91221/016	L 906 x P 668 x A 1500
91960/001	L 650 x P 550 x A 1500





informações para logística

information for logistics | informaciones para logística

	REF.	COR COLOR COLOR	EAN 78.977.462	EMB. PKG. EMB.					
				cm					
				UN.	KG	M ³	L	P	A
	91751/123	mel honey miel	0223 1	30	236	1,383	131	116	91
	91750/009	cinza gray gris	0243 9	12	1,30	0,012	26	23	20
	91750/130	natural	0513 3	30	165,00	1,013	122	100	83
	91750/140	natural	0895 0						
	91750/135	cinza gray gris	6670 7	6	13,481	0,052	90,9	26,5	21,6
	91750/136	cinza gray gris	6671 4	6	16,063	0,035	86,4	27	15
	91757/250	bege beige beige	6667 7	5	9,915	0,096	74,2	41,4	31,3
	91757/251	cinza gray gris	6669 1						
	91751/001	natural	1319 0	6	2,67	0,0297	44,5	15	44,5
	91751/002	cinza gray gris	1320 6						
	91751/006	natural	1321 3	6	2,67	0,0097	44,5	15	44,5
	91751/007	cinza gray gris	1322 0						
	91751/011	natural	1323 7	6	1,77	0,0097	26	10	37,5
	91751/012	cinza gray gris	1324 4						
	91751/021	natural	1329 9	6	1,28	0,0103	35	9,5	31
	91751/022	natural-cinza natural-gray natural- gris	1330 5						
	91751/023	cinza gray gris	1332 9						
	91751/024	cinza-natural gray-natural gris-natural	1333 6						
	91751/031	natural	1325 1	6	1,63	0,0103	35	9,5	31
	91751/032	natural-cinza natural-gray natural- gris	1326 8						
	91751/033	cinza gray gris	1327 5						
	91751/034	cinza-natural gray-natural gris-natural	1328 2						

	REF.	COR COLOR COLOR	EAN 78.977.462	EMB. PKG. EMB.					
				cm					
				UN.	KG	M ³	L	P	A
	91410/072	natural	0877 6	1	4,6	0,030	70,5	41	10,5
	91411/072	amarela yellow amarilla	0720 5						
	91411/172	amarela yellow amarilla	8006 2						
	91412/072	azul blue azul	0722 9						
	91412/172	azul blue azul	8007 9						
	91413/072	vermelha red roja	0724 3						
	91413/172	vermelha red roja	8008 6						
	91414/072	branca white blanca	9928 6						
	91414/172	branca white blanca	8009 3						
	91417/072	verniz varnished barniz	9926 2						
	91418/072	preta black negra	0562 1	1	3,73	0,016	45	34	10,5
	91418/172	preta black negra	8010 9						
	91417/078	preto e verniz black and varnisher negra e barniz	6364 5						
	91417/178	garapa	6878 7						
	91410/047	natural	0876 9						
	91411/047	amarela yellow amarilla	0719 9						
	91411/147	amarela yellow amarilla	8001 7						
	91412/047	azul blue azul	0721 2						
	91412/147	azul blue azul	8002 4						
	91413/047	vermelha red roja	0723 6						
	91413/147	vermelha red roja	8003 1	1	3,73	0,016	45	34	10,5
	91414/047	branca white blanca	9927 9						
	91414/147	branca white blanca	8004 8						
	91417/047	verniz varnished barniz	9925 5						
	91418/047	preta black negra	0563 8						
	91418/147	preta black negra	8005 5						
	91417/048	preto e verniz black and varnisher negra e barniz	6363 8						
	91417/148	garapa	6877 0						
	91442/072	cinza gray gris	6369 0						
		91444/072	branca white blanca						
91448/072		preta black negra	6371 3						
91449/072		camurça suede gamuza	6375 1						
91442/047		cinza gray gris	6365 2						
	91444/047	branca white blanca	6366 9	1	3,73	0,016	45	34	10,5
	91448/047	preta black negra	6367 6						
	91449/047	camurça suede gamuza	6368 3						
	91390/002	coral	1314 5						
	91390/002	coral	1314 5	10	8,66	0,059	48	28	43
	91390/002	coral	1314 5	120	118,00	0,893	114	98	80
	91390/003	camurça suede gamuza	1315 2	10	8,66	0,059	48	28	43
	91390/003	camurça suede gamuza	1315 2	120	118,00	0,893	114	98	80
	91390/004	branca white blanca	1316 9	10	8,66	0,059	48	28	43
	91390/004	branca white blanca	1316 9	120	118,00	0,893	114	98	80
	91390/008	preta black negra	1317 6	10	8,66	0,059	48	28	43
	91390/008	preta black negra	1317 6	120	118,00	0,893	114	98	80
	91390/108	preta black negra	0514 0	10	8,66	0,060	48	29	43
	91390/108	preta black negra	0514 0	120	118,00	0,894	114	98	80
	91394/108	branca white blanca	0523 2	10	8,66	0,060	48	29	43
	91394/108	branca white blanca	0523 2	120	118,00	0,894	114	98	80
	91390/119	grafite graphite grafito	6376 8	10	8,66	0,060	48	29	43
	91390/119	grafite graphite grafito	6376 8	120	118,00	0,894	114	98	80

	REF.	COR COLOR COLOR	EAN 78.977.462	EMB. PKG. EMB.					
				cm					
				UN.	KG	M ³	L	P	A
	91756/023	garapa	4243 5	1	13,5	0,0882	200	32	10,5
	91756/028		7243 2	1	22	0,1722	200	82	10,5
	91750/100	natural	9931 6	1	49,60	0,224	200,5	81	18
	91750/103	natural	0666 1	1	40,85	0,189	132	82	21,8
	91750/018	natural	0075 1	1	22,73	0,117	132	82	10,8
	91750/013	natural	0075 0	1	9,06	0,036	1115	29,5	11
	91750/028	natural	9930 9	1	26,40	0,114	200,5	81	7
	91750/023	natural	9929 3	1	11,60	0,065	201	29,5	11
	91750/073	natural	7799 4	1	11,33	0,027	75	42	8,5
	91751/073	amarela yellow amarilla	6327 0						
	91752/073	azul blue azul	6300 3						
	91753/073	vermelha red roja	6301 0						
	91754/073	branca white blanca	7799 4						
	91620/610	natural	1410 4	3	5,89	0,0219	56,2	24,6	15,9









	REF.	COR COLOR COLOR	EAN 78.977.462	EMB. PKG. EMB.					
				cm					
				UN.	KG	M ³	L	P	A
	91220/410	transparente	0828 8	6	5,10	0,008	42	11,5	16
	91220/415		0831 1	6	7,80	0,011	42	16,5	16
	91220/420		0832 5	6	10,20	0,014	42	21,5	16
	91220/510		0834 9	6	6,50	0,010	52	11,5	16
	91220/515		0835 6	6	9,50	0,014	52	16,5	16
	91220/520		0836 3	6	12,50	0,018	52	21,5	16
	91220/610		6700 1	6	7,15	0,011	62	11,5	16
	91220/615		6701 8	6	10,85	0,016	62	16,5	16
	91220/620		67025	6	13,89	0,021	62	21,5	16
	91220/002		0823 3	transparente	1	4,13	0,008	22	23
91220/025	0837 0	6	6,30		0,010	27,5	28	12,5	
91220/003	0824 0	6	8,80		0,013	32	33	12	
91221/002	0825 7	transparente	6	4,13	0,008	22	23	16	
91221/025	0839 4		6	6,30	0,010	27,5	28	12,5	
91221/003	0827 1		6	8,80	0,013	32	33	12	
	91284/645	branca white blanca	6634 9	5	15,87	0,0297	61,5	46	10,5
	91283/067	maple	0972 8	5	8,33	0,015	64	26	9
	91283/097		0975 9	5	11,16	0,022	94	26	9
	91283/127		0978 0	5	14,66	0,029	124	26	9
	91286/067	castanho escuro castaño oscuro dark brown	0973 5	5	8,33	0,015	64	26	9
	91286/097		0976 6	5	11,16	0,022	94	26	9
	91286/127		0979 7	5	14,66	0,029	124	26	9
	91287/067	noce brianza	0974 2	5	8,33	0,015	64	26	9
	91287/097		0977 3	5	11,16	0,022	94	26	9
	91287/127		0980 3	5	14,66	0,029	124	26	9
	91284/067	branca white blanca	7774 1	5	8,33	0,015	64	26	9
	91284/097		7773 4	5	11,16	0,022	94	26	9
	91284/127		7772 7	5	14,66	0,029	124	26	9
	91285/067	amêndoa almond almendra	9812 8	5	8,33	0,015	64	26	9
	91285/097		9813 5	5	11,16	0,022	94	26	9
	91285/127		9814 2	5	14,66	0,029	124	26	9
	91283/041	maple	6600 4	6	7,33	0,017	41	26	16
	91283/061		6270 9	6	8,33	0,025	61	26	16
	91283/091		6271 6	6	12,70	0,038	91	26	16
	91283/121		6272 3	6	15,33	0,050	121	26	16
	91286/041	castanho escuro castaño oscuro dark brown	6603 5	6	7,33	0,017	41	26	16
	91286/061		6270 9	6	8,33	0,025	61	26	16
	91286/091		0976 6	6	12,70	0,038	91	26	16
	91286/121		0979 7	6	15,33	0,050	121	26	16
	91287/041	noce brianza	6604 2	6	7,33	0,017	41	26	16
	91287/061		0974 2	6	8,33	0,025	61	26	16
	91287/091		0977 3	6	12,70	0,038	91	26	16
	91287/121		0980 3	6	15,33	0,050	121	26	16
	91284/041	branca white blanca	6601 1	6	7,33	0,017	41	26	16
	91284/061		7774 1	6	8,33	0,025	61	26	16
	91284/091		7773 4	6	12,70	0,038	91	26	16
	91284/121		7772 7	6	15,33	0,050	121	26	16
	91285/041	amêndoa almond almendra	66028	6	7,33	0,017	41	26	16
	91285/061		9812 8	6	8,33	0,025	61	26	16











informações para logística

information for logistics | informaciones para logística

REF.	COR COLOR COLOR	EAN 78.977.462	EMB. PKG. EMB.					
			cm					
			UN.	KG	M ³	L	P	A
91285/091	amêndoa almond almendra	9813 5	6	12,70	0,038	91	26	16
91285/121		9814 2	6	15,33	0,050	121	26	16
91273/065	maple	0981 0	3	6,83	0,019	61	26,5	12
91273/095		0984 1	3	8,36	0,029	91	26,5	12
91273/125		0987 2	3	12,76	0,038	121	26,5	12
91276/065	castanho escuro castaño oscuro dark brown	0982 7	3	6,83	0,019	61	26,5	12
91276/095		0985 8	3	8,36	0,029	91	26,5	12
91276/125	0988 9	3	12,76	0,038	121	26,5	12	
91277/065	noce brianza	0983 4	3	6,83	0,019	61	26,5	12
91277/095		0986 5	3	8,36	0,029	91	26,5	12
91277/125		0989 6	3	12,76	0,038	121	26,5	12
91274/065	branca white blanca	7777 2	3	6,83	0,019	61	26,5	12
91274/095		7775 8	3	8,36	0,029	91	26,5	12
91274/125	7776 5	3	12,76	0,038	121	26,5	12	
91275/065	amêndoa almond almendra	0564 5	3	6,83	0,019	61	26,5	12
91275/095		0754 0	3	8,36	0,029	91	26,5	12
91275/125		9811 1	3	12,76	0,038	121	26,5	12
91240/052	natural	0130 2	10	10,73	0,028	51	20	27
91244/052	branca white blanca	1302 2	10	10,73	0,028	51	20	27
91246/052	castanho escuro castaño oscuro dark brown	1303 9	10	10,73	0,028	51	20	27
91200/002	natural	0005 3	6	2,50	0,007	24,5	21	13
91200/003		0006 0	6	5,15	0,014	34,5	31	13
91200/004		0007 7	6	8,33	0,024	44,5	41	13
91201/002	mel honey miel	0068 8	6	2,50	0,007	24,5	21	13
91201/003		0069 5	6	5,15	0,014	34,5	31	13
91201/004		0070 1	6	8,33	0,024	44,5	41	13
91204/002	branca white blanca	0103 6	6	2,50	0,007	24,5	21	13
91204/003		0104 3	6	5,15	0,014	34,5	31	13
91204/004		0105 0	6	8,33	0,024	44,5	41	13
91206/002	castanho escuro castaño oscuro dark brown	0321 4	6	2,50	0,007	24,5	21	13
91206/003		0322 1	6	5,15	0,014	34,5	31	13
91206/004		0323 8	6	8,33	0,024	44,5	41	13
91240/042	natural	0359 7	6	6,16	0,016	41	21	18,5
91240/062		0008 4	6	9,16	0,024	61	21	18,5
91240/092		0009 1	6	12,00	0,035	91	21	18,5
91240/122	0350 4	6	16,00	0,047	121	21	18,5	
91241/042	mel honey miel	0360 3	6	6,16	0,016	41	21	18,5
91241/062		0074 9	6	9,16	0,024	61	21	18,5
91241/092		0075 6	6	12,00	0,035	91	21	18,5
91241/122	0076 3	6	16,00	0,047	121	21	18,5	
91244/042	branca white blanca	0362 7	6	6,16	0,016	41	21	18,5
91244/062		0106 7	6	9,16	0,024	61	21	18,5
91244/092		0107 4	6	12,00	0,035	91	21	18,5
91244/122	0108 1	6	16,00	0,047	121	21	18,5	
91246/042	castanho escuro castaño oscuro dark brown	0363 4	6	6,16	0,016	41	21	18,5
91246/062		0251 4	6	9,16	0,024	61	21	18,5
91246/092		0252 1	6	12,00	0,035	91	21	18,5
91246/122		0253 8	6	16,00	0,047	121	21	18,5

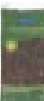
REF.	COR COLOR COLOR	EAN 78.977.462	EMB. PKG. EMB.					
			cm					
			UN.	KG	M ³	L	P	A
91150/062	natural C/C	2028 0	5	6,28	0,012	61	21	9,5
91150/063		2029 7	5	9,18	0,018	61	31	9,5
91150/082		2030 3	5	8,28	0,016	81	21	9,5
91150/083		2048 8	5	12,13	0,024	81	31	9,5
91150/084		2031 0	5	15,97	0,032	81	41	9,5
91150/102		2032 7	5	10,27	0,02	101	21	9,5
91150/103		2049 5	5	15,07	0,03	101	31	9,5
91150/104		2033 4	5	19,87	0,039	101	41	9,5
91150/122		2034 1	5	12,27	0,024	121	21	9,5
91150/123		2035 8	5	18,02	0,036	121	31	9,5
91150/124		2036 5	5	23,77	0,047	121	41	9,5
91150/126		2037 2	5	35,26	0,07	121	61	9,5
91150/152		2038 9	5	15,26	0,03	151	21	9,5
91150/153		2039 6	5	22,43	0,044	151	31	9,5
91150/154		2040 2	5	29,61	0,059	151	41	9,5
91150/156	2041 9	5	43,95	0,088	151	61	9,5	
91150/202	2050 1	5	20,25	0,04	201	21	9,5	
91150/203	2042 6	5	29,8	0,059	201	31	9,5	
91150/206	2043 3	5	58,44	0,116	201	61	9,5	
91155/128	1312 1	1	12	0,024	121	81	2,2	
91155/168	1313 8	1	16	0,032	161	81	2,2	
91131/062	mel honey miel	0268 2	5	6,28	0,012	61	21	9,5
91131/063		0269 9	5	9,18	0,018	61	31	9,5
91131/082		0270 5	5	8,28	0,016	81	21	9,5
91131/083		0271 2	5	12,13	0,024	81	31	9,5
91131/102		0272 9	5	10,27	0,02	101	21	9,5
91131/103		0273 6	5	15,07	0,03	101	31	9,5
91131/122	0274 3	5	12,27	0,024	121	21	9,5	
91131/123	0275 0	5	18,02	0,036	121	31	9,5	
91133/062	branca white blanca	0281 1	5	6,28	0,012	61	21	9,5
91133/063		0282 8	5	9,18	0,018	61	31	9,5
91133/082		0283 5	5	8,28	0,016	81	21	9,5
91133/083		0284 2	5	12,13	0,024	81	31	9,5
91133/102		0285 9	5	10,27	0,02	101	21	9,5
91133/103		0286 6	5	15,07	0,03	101	31	9,5
91133/122	0287 3	5	12,27	0,024	121	21	9,5	
91133/123	0288 0	5	18,02	0,036	121	31	9,5	
91136/062	castanho escuro castaño oscuro dark brown	0294 1	5	6,28	0,012	61	21	9,5
91136/063		0295 8	5	9,18	0,018	61	31	9,5
91136/082		0296 5	5	8,28	0,016	81	21	9,5
91136/083		0297 2	5	12,13	0,024	81	31	9,5
91136/102		0298 9	5	10,27	0,02	101	21	9,5
91136/103		0299 6	5	15,07	0,03	101	31	9,5
91136/122	0300 9	5	12,27	0,024	121	21	9,5	
91136/123	0301 6	5	18,02	0,036	121	31	9,5	
91154/062	branca borda PVC white PVC edge blanca border PVC	0530 0	5	6,28	0,012	61	21	9,5
91154/063		0531 7	5	9,18	0,018	61	31	9,5
91154/064		0532 4	5	12,19	0,012	61	41	9,5
91154/082		0533 1	5	8,28	0,016	81	21	9,5
91154/083		0534 8	5	12,13	0,024	81	31	9,5
91154/084		0535 5	5	15,97	0,032	81	41	9,5
91154/102		0536 2	5	10,27	0,02	101	21	9,5
91154/103		0537 9	5	15,03	0,03	101	31	9,5
91154/104		0538 6	5	19,87	0,039	101	41	9,5
91154/122		0539 3	5	12,27	0,024	121	21	9,5
91154/123		0540 9	5	18,02	0,036	121	31	9,5
91154/124		0541 6	5	23,77	0,047	121	41	9,5
91154/126		0542 3	5	35,26	0,07	121	61	9,5
91154/152		0543 0	5	15,26	0,03	151	201	9,5
91154/153		0544 7	5	22,43	0,044	151	301	9,5
91154/154	0545 4	5	19,61	0,059	151	41	9,5	
91154/156	0546 1	5	43,95	0,088	151	61	9,5	
91154/202	0547 8	5	20,25	0,04	201	201	9,5	
91154/203	0548 5	5	29,80	0,059	201	31	9,5	
91154/206	0549 2	5	54,44	0,116	201	61	9,5	

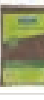
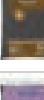
	REF.	COR COLOR COLOR	EAN 78.977.462	EMB. PKG. EMB.					
				cm					
				UN.	KG	M ³	L	P	A
	91122/062	natural A/B	0023 7	5	6,28	0,012	61	21	9,5
	91122/063		0029 9	5	9,18	0,018	61	31	9,5
	91122/082		0024 4	5	8,28	0,016	81	21	9,5
	91122/083		0030 5	5	12,13	0,024	81	31	9,5
	91122/102		0025 1	5	10,27	0,02	101	21	9,5
	91122/103		0031 2	5	15,07	0,03	101	31	9,5
	91122/122		0026 8	5	12,27	0,024	121	21	9,5
	91122/123		0635 2	5	13,33	0,026	121	31	7
	91122/152		0027 5	5	15,26	0,03	151	21	9,5
	91122/153		0033 6	5	22,43	0,044	151	31	9,5
	91122/154		0136 4	5	29,61	0,059	151	41	9,5
	91122/202		0028 2	5	20,25	0,04	201	21	9,5
	91122/203		0034 3	5	29,8	0,059	201	31	9,5
			91804/010	branca white blanca	0550 8	1	0,10	0,0004	17
91804/011		0551 5	1		0,25	0,001	20	20	1,4
	91804/030	branca white blanca	0552 2	1	0,25	0,001	27	15,5	1,8
	91804/040		0553 9	1	0,35	0,001	35	20	1,9
	91804/001	branca white blanca	0244 6	1	0,005	0,0005	15	10	3
	91804/002		0249 1	1	0,08	0,001	20	15	3,5
	91804/003		0250 7	1	0,12	0,002	25	20	4,3
	91804/004		0524 9	1	0,155	0,003	30	25	4,3
	91809/001	preta black negra	1375 6	1	0,005	0,0005	15	10	3
	91809/002		1377 0	1	0,08	0,001	20	15	3,5
	91809/003		1379 4	1	0,12	0,002	25	20	4,3
	91809/004		1381 7	1	0,155	0,003	30	25	4,3
	91289/009	preta black negra	0118 0	1	0,20	0,001	28	10	1,8
	91284/009	branca white blanca	0010 7	1	0,20	0,001	28	10	1,8
	91622/016	natural	6809 1	1	2,72	0,008	59	13	11
	91620/017		0948 3	1	4,40	0,011	75	13	11
	91620/018		0949 0	1	7,10	0,019	149	13	10
	91620/019		6704 9	1	5,44	0,015	118	13	10
	91620/020		6705 6	1	8,16	0,023	177	13	10
	91621/002		6706 3	1	4,00	0,011	87	13	10
	91621/003		6707 0	1	5,34	0,012	87	13	11
	91621/004		6708 7	1	7,11	0,017	116	13	11
	91621/005		6709 4	1	9,34	0,025	173	13	11
	91621/006		6800 8	1	10,68	0,025	173	13	11
			91620/610	natural	1410 4	3	5,89	0,0219	56,2
	91900/071	natural	0950 6	10	10,33	0,049	47	28	37

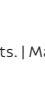
	REF.	COR COLOR COLOR	EAN 78.977.462	EMB. PKG. EMB.					
				cm					
				UN.	KG	M ³	L	P	A
	91150/100	natural	1308 4	1	5,16	0,0136	100	19	7,2
	91150/110	natural	1309 1	1	6,30	0,0261	100	29	9
	91150/101	natural	1336 7	1	5,16	0,1265	56	22,6	100
	91150/111	natural	1337 4	1	6,30	0,0261	56	36	100
	91960/001	-	0193 7	1	25,00	0,080	149	89	6,0
	91221/016	-	0665 9	1	25,00	0,080	149	89	6,0
	91401/003		1340 4	1	0,3	0,001457	23,5	15,5	4
	91401/001			30	9	0,040320	64	30	21
	91401/005			1	1	0,004128	32	21,5	6
	91401/008			10	10	0,040320	64	30	21
	91401/005		1351 0	1	5	0,025228	53	34	14
	91401/008			1	8	0,034706	67	37	14
	91402/003			1	0,3	0,001457	23,5	15,5	4
	91402/001			30	9	0,040320	64	30	21
	91402/001		1344 2	1	1	0,004128	32	21,5	6
	91402/005			10	10	0,040320	64	30	21
	91402/005			1	5	0,025228	53	34	14
	91402/008			1	8	0,034706	67	37	14
	91403/003		1342 8	1	0,3	0,001457	23,5	15,5	4
	91403/001			30	9	0,040320	64	30	21
	91403/005			1	1	0,004128	32	21,5	6
	91403/008			10	10	0,040320	64	30	21
	91404/001		1346 6	1	1	0,004128	32	21,5	6
	91404/005			10	10	0,040320	64	30	21
	91404/008			1	5	0,025228	53	34	14
	91404/008			1	8	0,034706	67	37	14
	91400/010		1350 3	1	1	0,004128	32	21,5	6
	91400/012			10	10	0,040320	64	30	21
	91400/011			1	2	0,005467	35,5	22	7
	91400/020			10	20	0,050820	77	33	20
	91400/020		1361 9	1	10	0,029184	64	38	12
	91400/021			1	1	0,003364	32,5	23	4,5
	91400/025			10	10	0,022440	55,00	34,00	12,00
	91400/030			1	1	0,003364	32,5	23	4,5
	91400/021		1348 0	1	1	0,003364	32,5	23	4,5
	91400/025			10	10	0,037944	68	31	18
	91400/025			1	5	0,022440	55	34	12
	91400/030			1	1	0,002550	31	23,5	3,5
	91400/030		1347 3	10	10	0,028640	52	30	19



SUSTENTABILIDADE E RESPONSABILIDADE SOCIAL PARA O MUNDO

A Tramontina tem em sua essência a preocupação em contribuir com a preservação dos recursos naturais e com a qualidade de vida das pessoas. Compreendemos a importância de seguir investindo em soluções ambientalmente corretas de acordo com os critérios ESG para muito além das obrigações legais. As práticas sustentáveis já fazem parte da história da marca desde a sua criação e ganham força e escala com o tempo.

Além de observar os aspectos ambientais, cuidar das pessoas através da educação e de ações de promoção de uma alimentação mais saudável é parte do propósito da marca. Crescer para transformar vidas. Criar laços para evoluirmos juntos.

É fazendo bonito, bem feito e correto que a Tramontina segue se desenvolvendo, em busca de manter a qualidade dos seus produtos, valorizando as pessoas, cuidando do meio ambiente e investindo em tecnologia e tendências.

Saiba mais em: tra.mn/sustentabilidade



SUSTAINABILITY AND SOCIAL RESPONSIBILITY FOR THE WORLD

Tramontina has in its core the concern of contributing to the preservation of natural resources and people's quality of life. We understand the importance of continuing to invest in environmentally correct solutions in accordance with ESG criteria far beyond the obligation. Sustainable practices have been part of the brand's history since its creation and have gained strength and scale over time.

In addition to observing environmental aspects, taking care of people through education and actions to promote healthier nutrition is part of the brand's purpose. Growing to transform lives. Creating bonds to evolve together.

It is by doing things beautifully, right and well done that Tramontina continues to develop, seeking to maintain the quality of its products, valuing people, taking care of the environment and investing in technology and trends.

Learn more at: tra.mn/sustainability

SUSTENTABILIDAD Y RESPONSABILIDAD SOCIAL PARA EL MUNDO

Tramontina posee en su esencia la preocupación por ayudar a preservar los recursos naturales y la calidad de vida de las personas. Comprendemos la importancia de seguir invirtiendo en soluciones ambientalmente correctas de acuerdo con los criterios ESG y mucho más allá de lo obligatorio. Las prácticas sustentables ya son parte de la historia de la marca desde su creación y con el tiempo ganan fuerza y escala.

Además de respetar los aspectos ambientales, el cuidado de las personas a través de la educación y con acciones tendientes a promover una alimentación más saludable es parte del propósito de la marca. Crecer para transformar vidas. Crear vínculos para progresar juntos.

Es al hacerlo mejor, correcto y bien hecho que Tramontina sigue desarrollándose, buscando mantener la calidad de sus productos, valorando a las personas, cuidando el medio ambiente e invirtiendo en tecnologías y tendencias.

Sepa más en: tra.mn/sustentabilidad.



TRAMONTINA

TRAMONTINA MADEIRAS S.A.
Rodovia Prefeito Hercio Alves Rodrigues,
RSC 471, Km 233 | CEP 96610-000
Encruzilhada do Sul | RS | Brasil
CNPJ 93.682.854/0001-86
Indústria Brasileira

